



QwikConnect

GLENAIR ■ APRIL 2015 ■ VOLUME 19 ■ NUMBER 2

SPACE GRADE
NASA
ESA, JAXA
SCREENED

SPECIAL FEATURE

ESA/Glenair
Interconnect
Part Number
Reference
Guide

Glenair®

International
Partnerships
and the Future of
Space Exploration

International Partnerships and the Future of Space Exploration

It has now been some four years since the **American Space Shuttle** program completed its final voyage. The four-person crew for the 135th and last mission of the grand Reusable Launch Vehicle (RLV) program was the smallest of any shuttle mission since STS-6 in April 1983. But its primary cargo, a Multi-Purpose Logistics Module (MPLM), was as important as any Atlantis (or any of the other four, low-earth orbiter shuttles) ever carried. Named "**Raffaello**"—after Raffaello Sanzio, an Italian painter and architect of the Renaissance—the MPLM was the second of three built by Thales Alenia to serve as "moving vans," carrying equipment, experiments and supplies to and from the International Space Station (ISS).

For the many international organizations involved in the shuttle program, the last mission represented the end of a major era for manned and unmanned space flight. Today, **NASA's Commercial Crew Development (CCDev)** space technology program is actively working toward producing a successor to the Shuttle, which is expected in late 2017. In the meantime, the ISS has **partnered with Roscosmos**, the Russian space agency, and their Soyuz vehicle for crew delivery and return flights—as have JAXA, ESA and other agencies committed to space environment research and development. Worldwide, a growing number of private and commercial vehicle launch enterprises, such as U.S.-based **Blue Origin (New Shepard)** are not sitting idle awaiting the fruits of the CCDev effort.

The growth of private, commercially-owned space programs, in partnership with governmental space agencies including **NASA, JAXA, ESA and Roscosmos**, has become the major source of innovation and velocity in current-day space exploration. This special space issue of **QwikConnect** highlights some of the more significant of these launch and payload partnerships. We also present an in-depth cross-reference and guide to Glenair's worldwide Micro-D and Nanominiature connector solutions for space-grade applications, particularly for new **ESA projects and programs**.

ULA Delta II lifts off carrying NASA's NPP spacecraft and five small CubeSat research satellites, including M-Cubed, and JPL's COVE Earth science technology experiment.

Photo: NASA/ULA

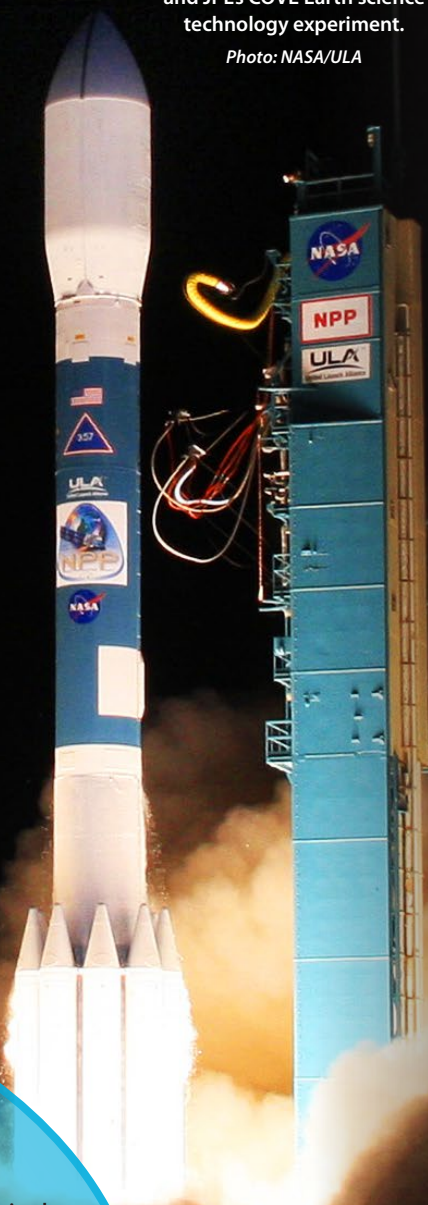

JAXA's Japanese Experiment Module (nicknamed "Kibo") consists of a Pressurized Module where astronauts conduct microgravity experiments; and the Exposed Facility, a unique platform that is continuously exposed to the space environment.

Photo: NASA





The United Launch Alliance Atlas V rocket with the Landsat Data Continuity Mission (LDCM) spacecraft onboard. The LDCM mission is a collaboration between NASA and the U.S. Geological Survey to monitor the Earth's landscapes from space.

Photo: NASA



Ariane 5 launch of the XMM X-ray spectroscopy mission. ESA's Ariane 1 to 4 launched half of the world's commercial satellites. The advanced Ariane 5 is one of the most reliable and affordable launchers in the world.

Photo: NASA



International Launch Vehicle Programs

The top line for expendable launch capabilities in North America is the **United Launch Alliance (ULA)**, a broad-based collaboration between Lockheed Martin and Boeing. ULA fields the most experienced and successful teams staging both the Atlas and Delta launch technologies that have supported America's presence in space for more than 50 years. **The Atlas and Delta expendable launch vehicles** offer a wide variety of configurations for their commercial and government customers and are able to carry payloads weighing up to thousands of kilograms into Low Earth Orbit (LEO) and Geosynchronous Transfer Orbit (GTO). A solid manifest continues to support ULA through 2015.

ESA fields a family of three major launch vehicles which compete for launch business in all sectors of the space market. Rocket launches are carried out by Arianespace utilizing **Ariane 5, Soyuz-2** and **Vega class rockets**. Interestingly, ESA sponsored launches from its Guiana Space Centre are able to handle larger payloads than higher-altitude spaceports due to the center's proximity to the equator. Equatorial launches take advantage of the higher rotational velocity of the earth at the equator. The ability to place communication satellites more readily into equatorial orbit is a distinct advantage of **ESA's French Guiana space port**.

Vega is ESA's carrier for small satellites and is capable of delivering 300 to 1500 kg satellites and other payloads into low earth orbit. Vega's maiden launch from ESA's Guiana Space Center was on 13 February 2012. The Vega rocket design features three lower stage solid propulsion sections and a liquid propulsion upper stage (the AVUM). Vega is ideally suited for pin-point orbital insertion and its capability to deploy multiple payloads into different orbits.

Commercial Launch Vehicles

Several next-generation commercial options for launch capability also support this marketplace including

Orbital Sciences Corporation (Orbital) and their Pegasus

vehicle—an air-launched rocket capable of carrying small payloads (less than 500 kilograms) into Low-Earth Orbit

(LEO). The **Antares** rocket, formerly called the "Taurus II", is a two-stage launch vehicle designed for heavier Low Earth Orbit (LEO) insertions. Currently, the Antares rocket is one of two launch technologies supporting **NASA's Commercial Resupply Services (CRS) program**, delivering cargo payloads and supplies to the ISS on commercially-operated spacecraft.

One of the newest offerings for commercially-operated launch capability is the **New Shepard** vehicle developed by Blue Origin. Blue Origin is a private company founded by Amazon.com visionary Jeff Bezos that has achieved considerable credibility for their incremental technology approach to the development and launch of low earth orbit satellite systems.

Russian Proton UR 500 expendable launch system, first launched in 1965. Modern versions of the launch system are still in use, making it one of the most successful heavy boosters in the history of space flight.





The LE-7 first-stage liquid oxygen/hydrogen powered main engine of a JAXA H-IIB expendable launch vehicle

Photo: Masamic, Wikimedia Commons

manifest is now populated by a diverse customer base, including space station resupply missions (CRS), commercial satellite launch missions, and

US government science and national security missions. SpaceX is not slowing down anytime soon as they moving toward developing a **Heavy Lift version** of their **Falcon 9** rocket and a manned version of the Dragon spacecraft for NASA as part of the CCDev efforts.

Japan has developed a class of launch vehicles, called the **H-IIB** for support of satellite launch missions and cargo transport to the international space station. The two-stage liquid oxygen and liquid hydrogen propelled rocket utilizes distinctive strap-on solid rocket boosters for effective flight deployment of satellite payloads and equipment and commodities for the ISS. Launched from the **Tanegashima Space Center in Japan**, the expendable launch system is a partnership between Mitsubishi Heavy Industries and JAXA. Successful first flight of the **H-IIB** occurred on 10 September 2009. Subsequent flights have carried **Japanese, U.S., and Chinese-made telecommunication satellites**.

Aeronautical Launch Systems

The **Airborne Launch Assist Space Access (ALASA)** program sponsored by the **Defense Advanced Research Projects Agency (DARPA)** is a new launch program supporting the Small Satellite community (form factors up to 100-lb. [45 kg]). DARPA was established in 1958 principally to maintain the technological superiority of the U.S. military. To fulfill its mission, DARPA relies on **diverse partners** to apply multi-disciplinary approaches to develop innovative technologies through applied research. The ALASA is an ambitious project that aims to launch small satellites more quickly while dramatically reducing costs. The target goal of the project is propelling 100-lb. [45 kg] satellites into LEO within 24 hours of call-up, for less than \$1 million per launch. The basis of this program relies on a fighter jet (F-15) with an expendable launch vehicle mounted underneath it. Essentially, the fighter jet acts as the first stage of a rocket. After the aircraft flies to a specified altitude, it releases the expendable and can then return to land on a conventional runway. The ALASA system is designed to be "an alternative to ride-sharing for satellites," or when a small satellite hitches a ride into space on a rocket whose primary purpose is to boost a larger satellite. ALASA flight demonstrations are expected to begin in late 2015.

The ALASA Airborne Launch Assist Space Access uses an F-15 fighter jet as the "first stage" to launch an expendable vehicle with a small satellite payload.
Aritst's Rendering: U.S. Air Force



Page photo: A Minotaur I rocket carrying 11 small cubesat research satellites, part of NASA's Educational Launch of a Nanosatellite program.

Photo: NASA/Ali Stancil

Reusable Unmanned Spacecraft

What began as a NASA project in 1999 (before being transferred to the U.S. Department of Defense in 2004), the **Boeing X-37** is a reusable unmanned spacecraft. Also known as the **Orbital Test Vehicle (OTV)**, the X-37 is boosted into space by an Atlas V launch vehicle, then re-



The Boeing X-37 Orbital Test Vehicle reusable unmanned spacecraft taxis on the flightline at Vandenberg Air Force Base

Photo: US Air Force



enters Earth's atmosphere and lands as a space plane, similar to the Shuttle. The X-37 is operated by the United States Air Force for Orbital Spaceflight Missions with the goal of demonstrating reusable space technologies. It currently has completed three successful multi-month missions; the last one logging 22 months in space. There is little doubt that this robotic, winged, space vehicle will remain a unique contributor to the U.S. space presence in the next decade.

Satellites

Since the launch of **Explorer 1** in 1958, the United States has continued to advance its space satellite technologies and programs. Originally and exclusively designed for the intelligence community, the importance of government space vehicle and satellite hardware has grown far beyond military applications. Commercial service providers leveraging technology originally developed for government use are now providing a variety of real-time **communications, navigation, climate and environmental monitoring** using a broad spectrum of satellite technologies. Advances in materials science, photovoltaics and Gas Ion propulsion have enabled spacecraft designers to minimize structural mass and increase available power providing engineers and scientists increased capacity for their payloads and prolonged service life.

The **Inmarsat-5** satellite is a perfect example of such technology optimization. Inmarsat-5 utilizes a Boeing 702 HP (High Power) platform that will carry **89 Ka-band radio frequency beams** operating in geosynchronous orbit for flexible global coverage. The satellite is designed to generate approximately 15 kilowatts of power at the start of service and approximately 13.8 kilowatts at the end of its 15-year design life. To generate such high power, the spacecraft will use two **solar wings** that employ five panels each. Each panel will be populated with ultra triple-junction gallium arsenide solar cells. To help get the satellite into geosynchronous orbit, Inmarsat-5 will employ one 445 N (newton) liquid apogee rocket engine using a bi-propellant (fuel-oxidizer) mixture. Inmarsat-5 will also use **Boeing's Xenon Ion Propulsion System (XIPS)** for all on-orbit maneuvering. Pioneered by Boeing, XIPS is 10 times more efficient than conventional liquid rocket fuel systems. The **four 25-cm thrusters** will require only 5 kg of gas per year, which is a fraction of what traditional bipropellant or Arcjet systems consume. To put this into perspective, Inmarsat-5 will consume some 2000kg of fuel to reach its geosynchronous station, well before it's actively providing service.

Considering this large mass-fraction loss—expended in the initial life of the geosynchronous satellite—Boeing engineers continue to investigate the role of XIPS technology as a replacement to the standard liquid apogee rocket engine.



Sandia Labs engineer Steve Yearout displays a 1/15 scale model of a NAVSTAR Block IIR GPS satellite

Photo: Sandia labs/ Randy Montoya



Sandia National Laboratories

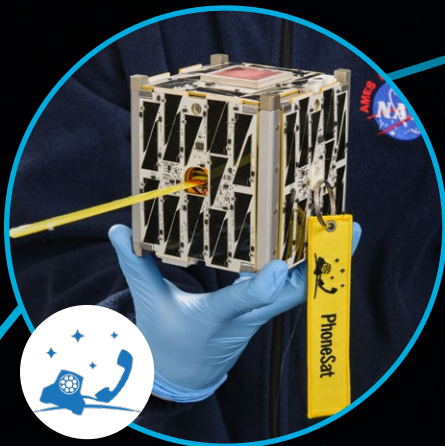

NASA PhoneSat: a smartphone-controlled nanosatellite that demonstrates how “off the shelf” consumer devices can lead to new space exploration capabilities.

Photo: NASA Ames Research Center/Dominic Hart

Key to their approach to this problem was the design of the **702SP (Small Platform) satellite**. The 702SP operates in the low- to mid-power ranges (3 to 8 kilowatts) and features an **all-electric propulsion system** employing their highly efficient XIPS. The mass of the 702SP is about half of a standard 702 satellite of equal performance. The 702SP’s lightweight system design allows for launch on most commercial launch systems, including Falcon 9. However, because of its lower mass and weight, two 702SP satellites may be launched on a single launch vehicle, resulting in a cost savings of up to 20 percent when compared with existing launch options. A joint procurement by **Asia Broadcast Satellite (ABS)** and **Eutelsat** (formerly Satmex) in March 2012 resulted in Boeing’s first order for the 702SP. The two all-electric propulsion satellites totaling 4149Kg were launched into a Geosynchronous Transfer Orbit on 1 March 2015.

The Small Satellite Community

The emerging small satellite community is an exciting and dynamic sector in the satellite market. This community is subdivided into four sub-categories based upon their respective launch masses: Mini (180 kg to 100 kg), Micro (100 kg to 10 kg), Nano (10 kg to 1 kg) and Pico (< 1 kg). Initially

used as an educational tool (at the university level) to provide graduate students low cost access to space, the utility of Small satellite technology has been proven over several decades of collaborative efforts by the academic, government and commercial sectors for roles in operational contexts such as earth observation, space weather, or situational awareness. Of particular interest in this community is the **Nano-Satellite subcategory**, which has been coined **CubeSat**.

CubeSat

CubeSats are cube shaped Nano-satellites with a nominal length of 100 mm per side for a 1 U (Unit) configuration (1 liter total volume), with a mass allocation of up to 1.33kg per unit. The technology dates from 1999 when members of the Engineering Department at **Cal Poly San Luis Obispo** defined the CubeSat format and began hardware development. Today the CubeSat Project is an international collaboration of over 40 universities, high schools, and private firms developing Pico-satellites containing scientific, private, and government payloads. **The CubeSat Standard** has been a key element of the project. Created by Cal Poly San Luis Obispo and Stanford Universities, the CubeSat Standard was designed to provide developers with necessary guidelines to interface with the Poly **Picosatellite Orbital Deployer**, or **P-POD**. The P-POD is a tubular, spring loaded mechanism used to safely store and deploy CubeSats on their respective launch vehicles. The standard also describes the outer dimensions, material and process recommendations, highlights restrictions, and describes schedule milestones pertaining to the integration and launch process.

The CubeSat platform has been steadily increasing in popularity since 2003, while attracting many high-profile participants including the **National Reconnaissance Organization (NRO)** with their Colony I and Colony II designs; the **Aerospace Corporation** with their AeroCube-3 built with funding from the U.S. Air Force Space and Missile Systems Center’s Developmental Planning Directorate; **Boeing Integrated Defense Systems** with their CSTB1 & CSTB2 designs, and Cal Poly San Luis Obispo with their CP-6 design in a collaboration with **The Naval Research Laboratory**.

In the past, each institution involved in CubeSats designed their own proprietary system with regards to communication, software, avionics, and command and control, with incremental improvements based on previous successes. While this made sense in an academic environment, it distracted teams exploring scientific or operational missions from focusing primarily on the payload technology. Building upon previous work funded by the **NRO’s Colony I and Colony II bus programs**, the Lawrence Livermore National Laboratory (LLNL), in partnership with

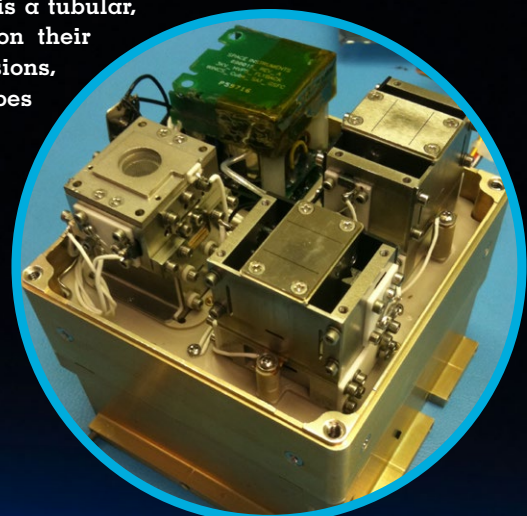

Close-up of the Winds-Ion-Neutral Composition Suite (WINDS) instrument: four spectrometers and three detectors in a three-inch, 1.3 watt package—specially designed to fly on Cubesats.

Photo: NASA/Debora McCallum



the Naval Postgraduate School (NPS) is currently developing a **CubeSat bus reference architecture** identified as Colony Next Generation Buss (CNGB) architecture. CNGB will offer a set of minimum specifications useful for government applications as well as applications to software, electrical, and mechanical interfaces. With the ultimate goal of providing a flexible CubeSat platform that can be endorsed by industry, supporting interchangeability of components while retaining customization for payload integration.

NASA CubeSat Launch initiative (CSLI)

NASA's CubeSat Launch initiative provides opportunities for small satellite payloads to fly on rockets planned for upcoming launches. These CubeSats are flown as auxiliary payloads on previously planned missions. CubeSats are a class of research spacecraft called nanosatellites. The cube-shaped satellites are approximately four inches long, have a volume of about one quart and weigh about 3 pounds. To participate in the CSLI program, CubeSat investigations must be consistent with NASA's Strategic Plan and the Education Strategic Coordination Framework. The research should address aspects of science, exploration, technology development, education or operations

Photo: Several tiny CubeSat satellites after launch from the Kibo laboratory on the ISS, photographed by an Expedition 33 crew member



Glenair and the European Space Agency (ESA)

The European Space Agency (ESA) is a multi-government space organization actively engaged in **manned and unmanned space exploration, scientific research, telecommunications and earth observation**. Established in 1975, ESA has played a significant role in human spaceflight through its participation in the International Space Station. Unmanned programs include space-science missions based at **ESTEC** in **The Netherlands**, Mars Orbiter and Earth Observation missions based at **ESRIN** in **Italy**.

ESA's Relationship with NASA

ESA has had a long and successful history of collaboration with NASA. **The American Space Shuttle** was the primary launch vehicle for **ESA manned missions** in the 1980s and 1990s, and the Spacelab program was managed jointly by ESA and NASA. Unmanned missions, including **Cassini-Huygens**, **The Infrared Space Observatory**, **INTEGRAL**, **The Hubble Space Telescope**, **SOHO**, and others are also examples of close collaboration between ESA and NASA. Future ESA-NASA joint projects are slated to include the **Laser Interferometer Space Antenna** and the **James Webb Space Telescope**. NASA has committed to supporting ESA's asteroid sampling mission, **MarcoPolo-R**.

Glenair interconnect technology has seen broad acceptance and application on both NASA and ESA space missions. Our Micro-D and nanominiature connectors, as well as numerous circular connector series and backshell technologies have been specified on ESA missions ranging from launch vehicles to spacecraft and satellites. This special edition of QwikConnect includes a **comprehensive ESA/Glenair interconnect part number reference guide**, as well as information on Glenair's capability to perform all the necessary **ESA screening, outgassing and testing requirements**.

From commercial launch technologies to nanominiature satellites, the new era of space has grown far beyond its origins as the sole provenance of government agencies with their military, intelligence and research agendas. Glenair is uniquely positioned to service both the broad range of interconnect requirements for **NASA, ESA and JAXA** approved projects as well as the emerging requirements from next-generation commercial launch, vehicle and satellite manufacturers.



Page photo: A set of NanoRacks CubeSats photographed by an ISS Expedition 38 crew member after deployment by the Launcher attached to the end of the JAXA robotic arm. The CubeSats program contains a variety of experiments such as Earth observations and advanced electronics testing.

Photo: NASA



Space-Grade Clean Room for Interconnect Assembly



Certified independent test labs



ESA and Mil-Standard soldering and crimping

GLENAIR UK QUALITY STANDARDS AND APPROVALS

- **New Space-Grade Clean Room for Micro-D and Nano Connector Assembly**
- **Quality Management System according to AS9120 Rev. A/BS EN 9120:9010 Rev. C/BS EN ISO 9001:2008**
- **Soldering and Crimping process according to ECSS-Q-ST-70-08, ECSS-Q-ST-70-26 and IPC-J-STD-001**
- **Independent Test Laboratory Certified to ISO/IEC 17025:2005, IECQ 01 and IECQ 03-6**
- **DSCC approved MIL-DTL-83513 assembler**

ESA Screened, US and UK Made Space-Grade Space-Flight Connectors

Glenair UK Ltd based in Mansfield, Nottinghamshire, UK is Glenair's Centre of Excellence for the design, build and qualification of its extensive Micro-D and Nano connector product portfolio for the European and global space market. Glenair UK have more than 30 years of experience in the manufacture of Micro-D and Nano connectors that meet and exceed the requirements of MIL-DTL-83513 and the MIL-DTL-32139 standard.

Glenair UK has been supplying the European and global space industry with high quality interconnect solutions for over 25 years. The products manufactured range from catalogue standard flying-lead and PCB mount connectors to complex super-screened cable assemblies. The broad range of additional interconnect technologies in the Glenair portfolio is fully supported by this European-based manufacturing and customer-service operation. Glenair Production staff are trained and qualified to the exacting standards of IPC WHMA-A-620 and ESA soldering and crimping process standards: ECSS-Q-ST-70-08 & ECSS-Q-ST-70-26.

The Glenair UK manufacturing facility has all of the core capabilities in-house to build the world's most reliable connector systems including design, machining, injection molding, space-grade clean room assembly and qualification testing.

The Glenair Space product portfolio is also supported by its own independently accredited test laboratory. Certified to ISO/IEC 17025:2005, Glenair's test laboratory is capable of running all industry standard qualification programs for its space flight customers—everything from outgassing to full qualification programs (ESA and NASA).

Glenair continues to support its ever-growing Space products portfolio with the commissioning of a new ISO Class 8 Clean Room IAW FED STD 209E class 100,000 (on-line 2015).

Introduction



Screening and Outgassing Mod Codes for Space Applications

Introduction

Section A



Space-Grade Micro-D Connectors, Backshells and Hardware

A

Section B

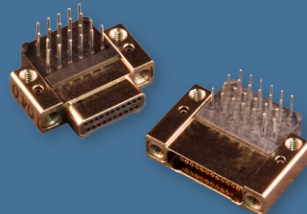

Space-Grade Nanominiature Connectors

B

Section C

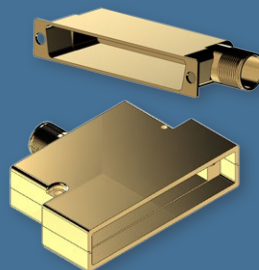

Space-Grade Lightweight Composite Backshells for Rectangular Connectors 3401/001 and /002

C

Section D



Sav-Con® Connector Savers and Gender Changers for Space Applications

D

ESA mod code 897 or NASA mod code 429 for Micro-D connectors

SAVE TIME AND COST WITH MOD CODE 897 OR 429 SPACE GRADE MICRO-D CONNECTORS

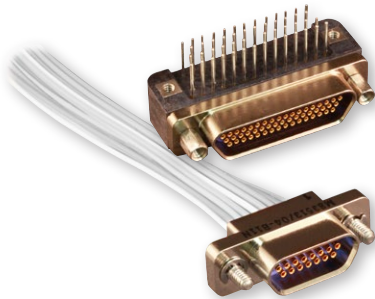

Micro-D TwistPin connectors are a good choice for all types of orbital and deep space projects. Glenair’s Mod Code 897 or 429 upgrades Micro-D’s to ESA or NASA requirements without the need for a customer Statement of Work or Specification Control Drawing. This section provides more detail on Glenair Mod Codes for NASA and ESA applications.

A Note on Outgassing Processing

The interfacial seals on Micro-D receptacles do not meet NASA requirements unless baked or thermal vacuum outgassed. Some customers specify deleting the seal, some opt for a bakeout, and some customers specify thermal vacuum outgassing. Mod codes for each option are provided in the table below. Note: ESA requirements (ESCC3401 and ESCC029) do not require a specific outgassing screen for interfacial seals.

How To Order Space Grade Micro-D’s

Step 1: Build a Micro-D part number that meets application requirements for number of circuits, termination, and so on. For your convenience, the how-to-order tables in this catalog only include appropriate options, such as gold or electroless nickel plated shells, that are approved for space.

Step 2: Determine required ESA or NASA Screening Level. The term “Screening Level” refers to the final inspection procedure.

- Level 1 for mission-critical highest reliability
- Level 2 for high reliability
- Level 3 for standard reliability

Step 3: Select the Mod Code from the table below that matches the desired level of screening (Level 1, 2, or 3) plus your choice of outgassing processing (oven bake or thermal vacuum). Add the mod code to the end of the connector part number. Example: MWDM2L-37P-6J5-18L-**429C**

Products ordered with Mod Code 897 or ESCC part numbers are manufactured according to ESCC3401, including all inline inspections and final inspection requirements. Mod code 897 is used for parts not fully covered by an ESCC detailed specification.

ESA and NASA Screening Levels and Modification Codes				
Screening Level	Special Screening Only		Special Screening Plus Outgassing Processing	
	Interfacial Seal is Installed	Interfacial Seal is Omitted	48 Hour Oven Bake 175° C	Thermal Vacuum Outgassing 24 hrs. 125° C
ESA Level 1 Highest Reliability	Mod Code 897E	Mod Code 897F	Mod Code 897J	Mod Code 897C
ESA Level 2 High Reliability	Mod Code 897B	Mod Code 897D	Mod Code 897K	Mod Code 897A
ESA Level 3 Standard Reliability	Mod Code 897	Mod Code 432	Mod Code 186	Mod Code 186M
NASA Level 1 Highest Reliability	Mod Code 429B	Mod Code 429F	Mod Code 429J	Mod Code 429C
NASA Level 2 High Reliability	Mod Code 429	Mod Code 429D	Mod Code 429K	Mod Code 429A
NASA Level 3 Standard Reliability	(Use standard part number)	Mod Code 432	Mod Code 186	Mod Code 186M

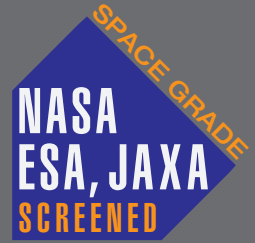

OUTGASSING FOR SPACE FLIGHT APPLICATIONS

Outgassing At-a-Glance

- **Fluorosilicone Interfacial Seals exceed NASA outgassing limits.**
- **NASA recommends removing the seal or performing a bakeout.**
- **An inexpensive oven bakeout delivers better results than more costly thermal vacuum outgassing.**
- **Glenair Mod 897 and 429 codes provide an easy ordering solution, whatever the outgassing option.**

What is outgassing?

Plastic and rubber materials give off gaseous molecules. For example, the smell inside a new car is caused by polymer outgassing. Heat and vacuum increase the rate of diffusion. In a spacecraft, the gases coming off polymers can contaminate optical surfaces and instruments. The result is degraded performance.

How is outgassing measured?

The space industry has adopted a standardized test procedure, ASTM E 595, to evaluate outgassing properties of polymers. Small samples of material are heated to 125° C. at a vacuum of 5×10^{-5} torr for 24 hours. Then the sample is weighed to calculate the Total Mass Loss (TML). The TML cannot exceed 1.00% of the total initial mass. During the test, outgassed matter condenses on a cooled collector plate. The quantity of outgassed matter is calculated to determine the Collected Volatile Condensable Material (CVCM). The CVCM cannot exceed 0.10% of the original specimen mass.

MIL-DTL-83513 specifies that Micro-D connectors must meet outgassing requirements, but the interfacial seal exceeds the limit. How can this be?

The mil spec allows the TML and CVCM to be calculated based on the total mass of the nonmetallic components. The interfacial seal can exceed outgassing limits as long as the insulator and potting compound are well below maximum outgassing limits.

Is special outgassing necessary?

It depends on the application. Some programs specify that all connectors be oven baked or thermal vacuum outgassed. For example, NASA GSFC programs typically require that the interfacial seals be removed, along with level I screening and thermal vacuum outgassing processing.

Why pay extra for bakeout or thermal vacuum outgassing?

If the interfacial seal is not removed, NASA recommends a bakeout process. The table below shows that a simple oven bake is sufficient to reduce volatile matter. Whatever level of outgas processing is ultimately required, the Glenair mod code system makes for easy ordering.

Outgassing Properties Of Micro-D Connectors					
Component	Material	Brand Name	% Total Mass Loss (TML)	% Collected Volatile Condensable Material (CVCM)	Test Report
Thermoplastic Insulators and PCB Trays	Liquid Crystal Polymer	Vectra® C-130	0.03	0.00	NASA Test #GSC17478
Potting Compound	Epoxy	Hysol C9-4215	0.48	0.01	Glenair Test
Interfacial Seal "as received"	Fluorosilicone	(none)	0.99	0.13	Glenair Test
Interfacial Seal with Oven Bakeout 8 hrs. 400° F.	Fluorosilicone	(none)	0.03	0.01	Glenair Test
Interfacial Seal with Thermal Vacuum Bakeout 24 hrs. 125° C.	Fluorosilicone	(none)	0.08	0.02	Glenair Test
Wire	Tefzel®	Tefzel®	0.22	0.01	NASA Test #GSC19998

Mod Code -897, ESA screening according to ESCC3401, paragraph 8.2 Lot Acceptance Testing

ESA SCREENING

ESA specification ESCC3401 provides instructions on selecting, screening and qualifying parts for use on ESA space flight projects. Chart V in the ESA spec contains specific inspection instructions for ESCC3401-029 issue 10 (MIL-DTL-83513) connectors. These screening requirements exceed the standard mil spec inspection levels.

SCREENING LEVELS

ESA defines three levels of screening: level 1 for highest reliability, level 2 for high reliability, and level 3 for standard reliability. Level 3 equates to standard ESA3401 acceptance testing.

ADDITIONAL SCREENING BY GLENAIR

Glenair has test procedures that go beyond the letter of the ESA spec. Meeting ESA requirements means not only inspecting per ESCC3401, but also building parts in accordance with ESA Technical Standard ESCC3401. Glenair fully meets these requirements. Our extra inspection steps reflect the fact that pre-wired connectors not only require best practices on the assembly floor, but also require thorough final electrical and mechanical testing.

QUALIFICATION REQUIREMENTS

Qualification is not necessarily required if the manufacturer has performed the LAT according to the ESCC3401 standard. Qualification by similarity is usually invoked for those connectors not specifically covered by the mil spec. Components ordered to ESCC P/Ns are manufactured and tested to fully comply to the applicable ESCC standard. Components ordered to Glenair P/Ns are manufactured and tested fully to the applicable Mil std. Both variants can be ordered with any level of ESA or NASA screening and/or removed or outgassed interfacial seals.

Summary of ESCC3401/ESCC3401-029 Test Requirements Included in Mod Code 897				MIL-DTL-83513
Requirement	Description			
Gold plating porosity and thickness	Shell: 0.7um minimum gold plating Contacts: 1.27um minimum gold over Cu.			N/A 1.27um gold over Ni
Crimp Capability	Per ESA PSS 01-725 (per (P/O)			Per MIL-STD-22520
Contact Capability per ESCC3401-029, para 4.3.3	Measurements	Pick-up	Drop weight	
	Weight (g)	14	170	Same
	Pin dia (mm)	0.582-0.587	0.559-0.564	Same
	Insert depth	1.5	1.5	Same/ Glenair standard prod. test
Dimensional inspection of contacts per ESCC3401, para 9.6	IAW ESA/SCC Basic Specification No. 20500 and the detailed Specification, to Inspection Level 2 an an Acceptance Quality Level of 1,0			100%/ Glenair standard prod. Test
Installation of Contacts	IAW the Process Identification Document			Same
Electrical Measurements per ESCC3401-029, Table II	Insulation resistance		Min. 5000MOhm	Min. 5000MOhm
	Voltage Proof, Leakage Current		Max. 2mA at 600Vrms	600Vrms
	Mated Shell Conductivity		No value	N/A
	Contact Resistance		Low level 6mOhm Rated current 5mOhm	28mOhm, incl. 6 inch AWG 26 wire
Mating Verification per ESCC3401, para 9.5	N/A, only applicable for circular connectors with integrated coupling mechanism.			N/A
Magnetism Level per ESCC 3401-029, para. 4.2.2	N/A			Permeability shall not exceed 2.0u
Connector Dimensional Check per ESCC3401	Physical dimensions match ESCC detailed specification ESCC3401-029 and ESCC 3401-041			Acc. To MIL-DTL-83513
Marking per ESCC3401, para 4.4	IAW ESA/SCC Basic Specification 21700			N/A
External Visual Inspection/ Visual Inspection of Piece Parts per ESCC3401, ¶ 9.7	IAW ESA/SCC Basic Specification No.20500 <ul style="list-style-type: none"> External surfaces - free of foreign particles and contamination. No evidence of corrosion, peeling of finish/plating nor of any holes or cracks. Marking - complies with detail spec and shows no damage or degradation Solder joints - Surface of the solder is smooth and clean. No Evidence of cracks, voids or holes. Structure of the soldered part is visible. Complete solder flow or coverage. No Balling or spherical appearance of the solder. No Evidence of foreign materials encapsulated in the solder. Materials and construction and dimensions per relevant ESCC Detail Spec for the specific part. 			Acc. to MIL-DTL-83513



LAT and/or outgassing test if required



NASA SCREENING

NASA specification EEE-INST-002 (see figure 1) provides instructions on selecting, screening and qualifying parts for use on NASA GSFC space flight projects. Table 2C in the NASA spec contains specific inspection instructions for MIL-DTL-83513 connectors. These screening requirements exceed the standard mil spec inspection levels.

SCREENING LEVELS

NASA defines three levels of screening: level 1 for highest reliability, level 2 for high reliability, and level 3 for standard reliability. Level 3 equates to standard M83513 Group A and B lot acceptance testing, and levels 1 and 2 call for additional testing.

ADDITIONAL SCREENING BY GLENAIR

Glenair has test procedures that go beyond the letter of the NASA spec. Meeting NASA requirements means not only inspecting per EEE-INST-002, but also building parts in accordance with NASA Technical Standard NASA-STD-8739.4 "Crimping, Interconnecting Cables, Harnesses, and Wiring". Glenair fully meets these requirements and has obtained NASA certification. Our extra inspection steps reflect the fact that pre-wired connectors not only require best practices on the assembly floor, but also require thorough final electrical and mechanical testing.

QUALIFICATION REQUIREMENTS

Qualification is not required if the manufacturer has performed qualification testing per MIL-DTL-83513. Qualification by similarity is usually invoked for those Micro-D's not specifically covered by the mil spec.

Due to the dynamic nature of this document, users are advised to check the <http://nepp.nasa.gov> website prior to every usage to obtain the latest document revision.

1.0 PURPOSE

The purpose of this document is to establish baseline criteria for selection, screening, qualification, and derating of EEE parts for use on NASA GSFC space flight projects. This document shall provide a mechanism to assure that appropriate parts are used in the fabrication of space hardware that will meet mission reliability objectives within budget constraints.

2.0 SCOPE

This document provides instructions for meeting three reliability levels of EEE parts requirements (see 6.0) based on mission needs. The terms "grade" and "level" are considered synonymous; i.e., a grade 1 part is consistent with reliability level 1. Levels of part reliability confidence decrease by reliability level, with level 1 being the highest reliability and level 3 the lowest. A reliability level 1 part has the highest level of manufacturing control and testing per military or DSCC specifications. Level 2 parts have reduced manufacturing control and testing. Level 3 Parts have no guaranteed reliability controls in the manufacturing process and no standardized testing requirements. The reliability of level 3 parts can vary significantly with each manufacturer, part type and LDC due to unreported and frequent changes in design, construction and materials.

GSFC projects and contractors shall incorporate this guideline into their Project EEE Parts Program.

3.0 DEFINITIONS

Screening. Screening tests are intended to remove nonconforming parts (parts with random defects that are likely to result in early failures, known as infant mortality) from an otherwise acceptable lot and thus increase confidence in the reliability of the parts selected for use.

Figure 1: Excerpt from NASA EEE-INST-002

Table 2: NASA Screening Requirements		
Inspection/ Test	NASA Level 1	NASA Level 2
Visual Inspection (3X magnification)	100%	100%
Mechanical	2 pcs.	2 pcs.
Voltage (DWV)	100%	2 pcs.
Insulation Resistance	2 pcs.	2 pcs.
Temperature Cycling	2 pcs.	N/A
Low Level Contact Resistance	2 pcs.	2 pcs.
Mating Force	2 pcs.	N/A
Solderability/Resistance to Soldering Heat	2 pcs.	N/A
Notes: 1. NASA screening requirements from Table 2J of EEE-INST-002.		

SPACE-GRADE MICRO-D CONNECTORS

MWDM Micro-D pigtail wire connectors

to ESCC3401-029 and MIL-DTL-83513

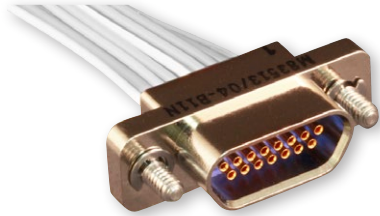

FEATURES

- High-quality TwistPin contact system
- MIL-DTL-83513 qualified
- Available with ESCC3901-002 56B and ESCC3901 013 wire
- Project-specific wired assemblies available
- Screened to ESA or NASA operational standards
- Manufactured in the EU

A

How To Order Insulated Wire Connectors										
Sample Part Number	MWDM	2	L	-15	P	6	G	1	-20	-897B
Series	MWDM Glenair Micro-D									
Shell Material and Finish	Aluminum Shell 2 - Nickel 5 - Gold									
Insulator Material	L - LCP - 30% Glass-Filled Liquid Crystal Polymer									
Contact Layout	9, 15, 21, 25, 31, 37, 51									
Contact Type	P - Pin S - Socket									
Wire Gage (AWG)	5 - #25 (uninsulated wire only) 6 - #26 8 - #28									
Wire Type	E - NEMA HP3-EB 600 VRMS Type E M16878/4 (TFE) G - ESCC3901-002 56B (26 AWG only) M - ESCC3901-013 C - Uninsulated solid wires (length 25.4mm)									
Wire Color	1 - White 2 - Natural (for G type wire only) 3 = (Gold-plated solid copper wire only)									
Wire Length Inches	1 - (25.4mm) 20 - (508mm) 36 - (914mm) 158 - (4000mm)									
Screening Mod Codes	-429 (NASA) -897 (ESA) Omit for no screening required (see table below)									

ESA and NASA Screening Levels and Modification Codes				
Screening Level	Special Screening Only		Special Screening Plus Outgassing Processing	
	Interfacial Seal is Installed	Interfacial Seal is Deleted	48 Hour Oven Bake 175° C	Thermal Vacuum Outgassing 24 hrs. 125° C
ESA Level 1 Highest Reliability	Mod Code 897E	Mod Code 897F	Mod Code 897J	Mod Code 897C
ESA Level 2 High Reliability	Mod Code 897B	Mod Code 897D	Mod Code 897K	Mod Code 897A
ESA Level 3 Standard Reliability	Mod Code 897	Mod Code 432	Mod Code 186	Mod Code 186M
NASA Level 1 Highest Reliability	Mod Code 429B	Mod Code 429F	Mod Code 429J	Mod Code 429C
NASA Level 2 High Reliability	Mod Code 429	Mod Code 429D	Mod Code 429K	Mod Code 429A
NASA Level 3 Standard Reliability	(Use standard part number)	Mod Code 432	Mod Code 186	Mod Code 186M

DIMENSIONS / WEIGHTS

Dimensions and other options are available in the *Glenair High-Performance Micro-D Connectors and Cables* catalog, page B-10. Weights according to ESCC 3401-029.

SCREENING

Add Mod Code -897 after the part number for ESA screening.
Add Mod Code -429 for NASA EEE-INS-002 screening.

SPACE-GRADE MICRO-D CONNECTORS

MWDM Micro-D pigtail wire connectors

ESA to Glenair Part Number cross-reference

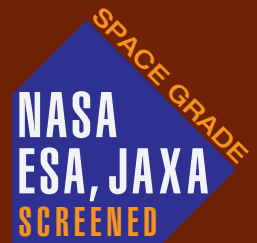

Micro-D 9 Way Pin			Micro-D 9 Way Socket		
ESA Basic Number	Variant no.	Glenair Part Number	ESA Basic Number	Variant no.	Glenair Part Number
ECSS340102901B	9PFR112	MWDM 2L 9P 6M1 20 - 897	ECSS340102901B	9SFR112	MWDM 2L 9S 6M1 20 - 897
ECSS340102902B	9PFR112	MWDM 5L 9P 6M1 20 - 897	ECSS340102902B	9SFR112	MWDM 5L 9S 6M1 20 - 897
ECSS340102901B	9PFR112A	MWDM 2L 9P 6G2 20 - 897	ECSS340102901B	9SFR112A	MWDM 2L 9S 6G2 20 - 897
ECSS340102902B	9PFR112A	MWDM 5L 9P 6G2 20 - 897	ECSS340102902B	9SFR112A	MWDM 5L 9S 6G2 20 - 897
ECSS340102901B	9PFR113	MWDM 2L 9P 6M1 36 - 897	ECSS340102901B	9SFR113	MWDM 2L 9S 6M1 36 - 897
ECSS340102902B	9PFR113	MWDM 5L 9P 6M1 36 - 897	ECSS340102902B	9SFR113	MWDM 5L 9S 6M1 36 - 897
ECSS340102901B	9PFR113A	MWDM 2L 9P 6G2 36 - 897	ECSS340102901B	9SFR113A	MWDM 2L 9S 6G2 36 - 897
ECSS340102902B	9PFR113A	MWDM 5L 9P 6G2 36 - 897	ECSS340102902B	9SFR113A	MWDM 5L 9S 6G2 36 - 897
ECSS340102901B	9PFR123	MWDM 2L 9P 6M1 158 - 897	ECSS340102901B	9SFR123	MWDM 2L 9S 6M1 158 - 897
ECSS340102902B	9PFR123	MWDM 5L 9P 6M1 158 - 897	ECSS340102902B	9SFR123	MWDM 5L 9S 6M1 158 - 897
ECSS340102901B	9PFR123A	MWDM 2L 9P 6G2 158 - 897	ECSS340102901B	9SFR123A	MWDM 2L 9S 6G2 158 - 897
ECSS340102902B	9PFR123A	MWDM 5L 9P 6G2 158 - 897	ECSS340102902B	9SFR123A	MWDM 5L 9S 6G2 158 - 897
ECSS340102901B	9PFR114	MWDM 2L 9P 8M1 20 - 897	ECSS340102901B	9SFR114	MWDM 2L 9S 8M1 20 - 897
ECSS340102902B	9PFR114	MWDM 5L 9P 8M1 20 - 897	ECSS340102902B	9SFR114	MWDM 5L 9S 8M1 20 - 897
ECSS340102901B	9PFR115	MWDM 2L 9P 8M1 36 - 897	ECSS340102901B	9SFR115	MWDM 2L 9S 8M1 36 - 897
ECSS340102902B	9PFR115	MWDM 5L 9P 8M1 36 - 897	ECSS340102902B	9SFR115	MWDM 5L 9S 8M1 36 - 897
ECSS340102901B	9PFR116	MWDM 2L 9P 5C3 1 - 897	ECSS340102901B	9SFR116	MWDM 2L 9S 5C3 1 - 897
ECSS340102902B	9PFR116	MWDM 5L 9P 5C3 1 - 897	ECSS340102902B	9SFR116	MWDM 5L 9S 5C3 1 - 897
Micro-D 15 Way Pin			Micro-D 15 Way Socket		
ESA Basic Number	Variant no.	Glenair Part Number	ESA Basic Number	Variant no.	Glenair Part Number
ECSS340102901B	15PFR112	MWDM 2L 15P 6M1 20 - 897	ECSS340102901B	15SFR112	MWDM 2L 15S 6M1 20 - 897
ECSS340102902B	15PFR112	MWDM 5L 15P 6M1 20 - 897	ECSS340102902B	15SFR112	MWDM 5L 15S 6M1 20 - 897
ECSS340102901B	15PFR112A	MWDM 2L 15P 6G2 20 - 897	ECSS340102901B	15SFR112A	MWDM 2L 15S 6G2 20 - 897
ECSS340102902B	15PFR112A	MWDM 5L 15P 6G2 20 - 897	ECSS340102902B	15SFR112A	MWDM 5L 15S 6G2 20 - 897
ECSS340102901B	15PFR113	MWDM 2L 15P 6M1 36 - 897	ECSS340102901B	15SFR113	MWDM 2L 15S 6M1 36 - 897
ECSS340102902B	15PFR113	MWDM 5L 15P 6M1 36 - 897	ECSS340102902B	15SFR113	MWDM 5L 15S 6M1 36 - 897
ECSS340102901B	15PFR113A	MWDM 2L 15P 6G2 36 - 897	ECSS340102901B	15SFR113A	MWDM 2L 15S 6G2 36 - 897
ECSS340102902B	15PFR113A	MWDM 5L 15P 6G2 36 - 897	ECSS340102902B	15SFR113A	MWDM 5L 15S 6G2 36 - 897
ECSS340102901B	15PFR123	MWDM 2L 15P 6M1 158 - 897	ECSS340102901B	15SFR123	MWDM 2L 15S 6M1 158 - 897
ECSS340102902B	15PFR123	MWDM 5L 15P 6M1 158 - 897	ECSS340102902B	15SFR123	MWDM 5L 15S 6M1 158 - 897
ECSS340102901B	15PFR123A	MWDM 2L 15P 6G2 158 - 897	ECSS340102901B	15SFR123A	MWDM 2L 15S 6G2 158 - 897
ECSS340102902B	15PFR123A	MWDM 5L 15P 6G2 158 - 897	ECSS340102902B	15SFR123A	MWDM 5L 15S 6G2 158 - 897
ECSS340102901B	15PFR114	MWDM 2L 15P 8M1 20 - 897	ECSS340102901B	15SFR114	MWDM 2L 15S 8M1 20 - 897
ECSS340102902B	15PFR114	MWDM 5L 15P 8M1 20 - 897	ECSS340102902B	15SFR114	MWDM 5L 15S 8M1 20 - 897
ECSS340102901B	15PFR115	MWDM 2L 15P 8M1 36 - 897	ECSS340102901B	15SFR115	MWDM 2L 15S 8M1 36 - 897
ECSS340102902B	15PFR115	MWDM 5L 15P 8M1 36 - 897	ECSS340102902B	15SFR115	MWDM 5L 15S 8M1 36 - 897
ECSS340102901B	15PFR116	MWDM 2L 15P 5C3 1 - 897	ECSS340102901B	15SFR116	MWDM 2L 15S 5C3 1 - 897
ECSS340102902B	15PFR116	MWDM 5L 15P 5C3 1 - 897	ECSS340102902B	15SFR116	MWDM 5L 15S 5C3 1 - 897

Mod code 897 applied to all connector part numbers. Complies with the test and screening requirements of ESCC 3401-029 level B and ESCC 3401



SPACE-GRADE MICRO-D CONNECTORS

MWDM Micro-D pigtail wire connectors



ESA to Glenair Part Number cross-reference

A

Micro-D 21 Way Pin			Micro-D 21 Way Socket		
ESA Basic Number	Variant no.	Glenair Part Number	ESA Basic Number	Variant no.	Glenair Part Number
ECSS340102901B	21PFR112	MWDM 2L 21P 6M1 20 - 897	ECSS340102901B	21SFR112	MWDM 2L 21S 6M1 20 - 897
ECSS340102902B	21PFR112	MWDM 5L 21P 6M1 20 - 897	ECSS340102902B	21SFR112	MWDM 5L 21S 6M1 20 - 897
ECSS340102901B	21PFR112A	MWDM 2L 21P 6G2 20 - 897	ECSS340102901B	21SFR112A	MWDM 2L 21S 6G2 20 - 897
ECSS340102902B	21PFR112A	MWDM 5L 21P 6G2 20 - 897	ECSS340102902B	21SFR112A	MWDM 5L 21S 6G2 20 - 897
ECSS340102901B	21PFR113	MWDM 2L 21P 6M1 36 - 897	ECSS340102901B	21SFR113	MWDM 2L 21S 6M1 36 - 897
ECSS340102902B	21PFR113	MWDM 5L 21P 6M1 36 - 897	ECSS340102902B	21SFR113	MWDM 5L 21S 6M1 36 - 897
ECSS340102901B	21PFR113A	MWDM 2L 21P 6G2 36 - 897	ECSS340102901B	21SFR113A	MWDM 2L 21S 6G2 36 - 897
ECSS340102902B	21PFR113A	MWDM 5L 21P 6G2 36 - 897	ECSS340102902B	21SFR113A	MWDM 5L 21S 6G2 36 - 897
ECSS340102901B	21PFR123	MWDM 2L 21P 6M1 158 - 897	ECSS340102901B	21SFR123	MWDM 2L 21S 6M1 158 - 897
ECSS340102902B	21PFR123	MWDM 5L 21P 6M1 158 - 897	ECSS340102902B	21SFR123	MWDM 5L 21S 6M1 158 - 897
ECSS340102901B	21PFR123A	MWDM 2L 21P 6G2 158 - 897	ECSS340102901B	21SFR123A	MWDM 2L 21S 6G2 158 - 897
ECSS340102902B	21PFR123A	MWDM 5L 21P 6G2 158 - 897	ECSS340102902B	21SFR123A	MWDM 5L 21S 6G2 158 - 897
ECSS340102901B	21PFR114	MWDM 2L 21P 8M1 20 - 897	ECSS340102901B	21SFR114	MWDM 2L 21S 8M1 20 - 897
ECSS340102902B	21PFR114	MWDM 5L 21P 8M1 20 - 897	ECSS340102902B	21SFR114	MWDM 5L 21S 8M1 20 - 897
ECSS340102901B	21PFR115	MWDM 2L 21P 8M1 36 - 897	ECSS340102901B	21SFR115	MWDM 2L 21S 8M1 36 - 897
ECSS340102902B	21PFR115	MWDM 5L 21P 8M1 36 - 897	ECSS340102902B	21SFR115	MWDM 5L 21S 8M1 36 - 897
ECSS340102901B	21PFR116	MWDM 2L 21P 5C3 1 - 897	ECSS340102901B	21SFR116	MWDM 2L 21S 5C3 1 - 897
ECSS340102902B	21PFR116	MWDM 5L 21P 5C3 1 - 897	ECSS340102902B	21SFR116	MWDM 5L 21S 5C3 1 - 897

Micro-D 25 Way Pin			Micro-D 25 Way Socket		
ESA Basic Number	Variant no.	Glenair Part Number	ESA Basic Number	Variant no.	Glenair Part Number
ECSS340102901B	25PFR112	MWDM 2L 25P 6M1 20 - 897	ECSS340102901B	25SFR112	MWDM 2L 25S 6M1 20 - 897
ECSS340102902B	25PFR112	MWDM 5L 25P 6M1 20 - 897	ECSS340102902B	25SFR112	MWDM 5L 25S 6M1 20 - 897
ECSS340102901B	25PFR112A	MWDM 2L 25P 6G2 20 - 897	ECSS340102901B	25SFR112A	MWDM 2L 25S 6G2 20 - 897
ECSS340102902B	25PFR112A	MWDM 5L 25P 6G2 20 - 897	ECSS340102902B	25SFR112A	MWDM 5L 25S 6G2 20 - 897
ECSS340102901B	25PFR113	MWDM 2L 25P 6M1 36 - 897	ECSS340102901B	25SFR113	MWDM 2L 25S 6M1 36 - 897
ECSS340102902B	25PFR113	MWDM 5L 25P 6M1 36 - 897	ECSS340102902B	25SFR113	MWDM 5L 25S 6M1 36 - 897
ECSS340102901B	25PFR113A	MWDM 2L 25P 6G2 36 - 897	ECSS340102901B	25SFR113A	MWDM 2L 25S 6G2 36 - 897
ECSS340102902B	25PFR113A	MWDM 5L 25P 6G2 36 - 897	ECSS340102902B	25SFR113A	MWDM 5L 25S 6G2 36 - 897
ECSS340102901B	25PFR123	MWDM 2L 25P 6M1 158 - 897	ECSS340102901B	25SFR123	MWDM 2L 25S 6M1 158 - 897
ECSS340102902B	25PFR123	MWDM 5L 25P 6M1 158 - 897	ECSS340102902B	25SFR123	MWDM 5L 25S 6M1 158 - 897
ECSS340102901B	25PFR123A	MWDM 2L 25P 6G2 158 - 897	ECSS340102901B	25SFR123A	MWDM 2L 25S 6G2 158 - 897
ECSS340102902B	25PFR123A	MWDM 5L 25P 6G2 158 - 897	ECSS340102902B	25SFR123A	MWDM 5L 25S 6G2 158 - 897
ECSS340102901B	25PFR114	MWDM 2L 25P 8M1 20 - 897	ECSS340102901B	25SFR114	MWDM 2L 25S 8M1 20 - 897
ECSS340102902B	25PFR114	MWDM 5L 25P 8M1 20 - 897	ECSS340102902B	25SFR114	MWDM 5L 25S 8M1 20 - 897
ECSS340102901B	25PFR115	MWDM 2L 25P 8M1 36 - 897	ECSS340102901B	25SFR115	MWDM 2L 25S 8M1 36 - 897
ECSS340102902B	25PFR115	MWDM 5L 25P 8M1 36 - 897	ECSS340102902B	25SFR115	MWDM 5L 25S 8M1 36 - 897
ECSS340102901B	25PFR116	MWDM 2L 25P 5C3 1 - 897	ECSS340102901B	25SFR116	MWDM 2L 25S 5C3 1 - 897
ECSS340102902B	25PFR116	MWDM 5L 25P 5C3 1 - 897	ECSS340102902B	25SFR116	MWDM 5L 25S 5C3 1 - 897

Mod code 897 applied to all connector part numbers. Complies with the test and screening requirements of ESCC 3401-029 level B and ESCC 3401

SPACE-GRADE MICRO-D CONNECTORS

MWDM Micro-D pigtail wire connectors

ESA to Glenair Part Number cross-reference

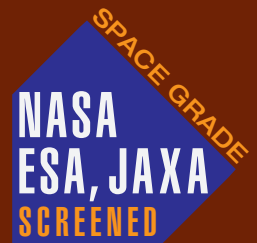

Micro-D 31 Way Pin			Micro-D 31 Way Socket		
ESA Basic Number	Variant no.	Glenair Part Number	ESA Basic Number	Variant no.	Glenair Part Number
ECSS340102901B	31PFR112	MWDM 2L 31P 6M1 20 - 897	ECSS340102901B	31SFR112	MWDM 2L 31S 6M1 20 - 897
ECSS340102902B	31PFR112	MWDM 5L 31P 6M1 20 - 897	ECSS340102902B	31SFR112	MWDM 5L 31S 6M1 20 - 897
ECSS340102901B	31PFR112A	MWDM 2L 31P 6G2 20 - 897	ECSS340102901B	31SFR112A	MWDM 2L 31S 6G2 20 - 897
ECSS340102902B	31PFR112A	MWDM 5L 31P 6G2 20 - 897	ECSS340102902B	31SFR112A	MWDM 5L 31S 6G2 20 - 897
ECSS340102901B	31PFR113	MWDM 2L 31P 6M1 36 - 897	ECSS340102901B	31SFR113	MWDM 2L 31S 6M1 36 - 897
ECSS340102902B	31PFR113	MWDM 5L 31P 6M1 36 - 897	ECSS340102902B	31SFR113	MWDM 5L 31S 6M1 36 - 897
ECSS340102901B	31PFR113A	MWDM 2L 31P 6G2 36 - 897	ECSS340102901B	31SFR113A	MWDM 2L 31S 6G2 36 - 897
ECSS340102902B	31PFR113A	MWDM 5L 31P 6G2 36 - 897	ECSS340102902B	31SFR113A	MWDM 5L 31S 6G2 36 - 897
ECSS340102901B	31PFR123	MWDM 2L 31P 6M1 158 - 897	ECSS340102901B	31SFR123	MWDM 2L 31S 6M1 158 - 897
ECSS340102902B	31PFR123	MWDM 5L 31P 6M1 158 - 897	ECSS340102902B	31SFR123	MWDM 5L 31S 6M1 158 - 897
ECSS340102901B	31PFR123A	MWDM 2L 31P 6G2 158 - 897	ECSS340102901B	31SFR123A	MWDM 2L 31S 6G2 158 - 897
ECSS340102902B	31PFR123A	MWDM 5L 31P 6G2 158 - 897	ECSS340102902B	31SFR123A	MWDM 5L 31S 6G2 158 - 897
ECSS340102901B	31PFR114	MWDM 2L 31P 8M1 20 - 897	ECSS340102901B	31SFR114	MWDM 2L 31S 8M1 20 - 897
ECSS340102902B	31PFR114	MWDM 5L 31P 8M1 20 - 897	ECSS340102902B	31SFR114	MWDM 5L 31S 8M1 20 - 897
ECSS340102901B	31PFR115	MWDM 2L 31P 8M1 36 - 897	ECSS340102901B	31SFR115	MWDM 2L 31S 8M1 36 - 897
ECSS340102902B	31PFR115	MWDM 5L 31P 8M1 36 - 897	ECSS340102902B	31SFR115	MWDM 5L 31S 8M1 36 - 897
ECSS340102901B	31PFR116	MWDM 2L 31P 5C3 1 - 897	ECSS340102901B	31SFR116	MWDM 2L 31S 5C3 1 - 897
ECSS340102902B	31PFR116	MWDM 5L 31P 5C3 1 - 897	ECSS340102902B	31SFR116	MWDM 5L 31S 5C3 1 - 897
Micro-D 37 Way Pin			Micro-D 37 Way Socket		
ESA Basic Number	Variant no.	Glenair Part Number	ESA Basic Number	Variant no.	Glenair Part Number
ECSS340102901B	37PFR112	MWDM 2L 37P 6M1 20 - 897	ECSS340102901B	37SFR112	MWDM 2L 37S 6M1 20 - 897
ECSS340102902B	37PFR112	MWDM 5L 37P 6M1 20 - 897	ECSS340102902B	37SFR112	MWDM 5L 37S 6M1 20 - 897
ECSS340102901B	37PFR112A	MWDM 2L 37P 6G2 20 - 897	ECSS340102901B	37SFR112A	MWDM 2L 37S 6G2 20 - 897
ECSS340102902B	37PFR112A	MWDM 5L 37P 6G2 20 - 897	ECSS340102902B	37SFR112A	MWDM 5L 37S 6G2 20 - 897
ECSS340102901B	37PFR113	MWDM 2L 37P 6M1 36 - 897	ECSS340102901B	37SFR113	MWDM 2L 37S 6M1 36 - 897
ECSS340102902B	37PFR113	MWDM 5L 37P 6M1 36 - 897	ECSS340102902B	37SFR113	MWDM 5L 37S 6M1 36 - 897
ECSS340102901B	37PFR113A	MWDM 2L 37P 6G2 36 - 897	ECSS340102901B	37SFR113A	MWDM 2L 37S 6G2 36 - 897
ECSS340102902B	37PFR113A	MWDM 5L 37P 6G2 36 - 897	ECSS340102902B	37SFR113A	MWDM 5L 37S 6G2 36 - 897
ECSS340102901B	37PFR123	MWDM 2L 37P 6M1 158 - 897	ECSS340102901B	37SFR123	MWDM 2L 37S 6M1 158 - 897
ECSS340102902B	37PFR123	MWDM 5L 37P 6M1 158 - 897	ECSS340102902B	37SFR123	MWDM 5L 37S 6M1 158 - 897
ECSS340102901B	37PFR123A	MWDM 2L 37P 6G2 158 - 897	ECSS340102901B	37SFR123A	MWDM 2L 37S 6G2 158 - 897
ECSS340102902B	37PFR123A	MWDM 5L 37P 6G2 158 - 897	ECSS340102902B	37SFR123A	MWDM 5L 37S 6G2 158 - 897
ECSS340102901B	37PFR114	MWDM 2L 37P 8M1 20 - 897	ECSS340102901B	37SFR114	MWDM 2L 37S 8M1 20 - 897
ECSS340102902B	37PFR114	MWDM 5L 37P 8M1 20 - 897	ECSS340102902B	37SFR114	MWDM 5L 37S 8M1 20 - 897
ECSS340102901B	37PFR115	MWDM 2L 37P 8M1 36 - 897	ECSS340102901B	37SFR115	MWDM 2L 37S 8M1 36 - 897
ECSS340102902B	37PFR115	MWDM 5L 37P 8M1 36 - 897	ECSS340102902B	37SFR115	MWDM 5L 37S 8M1 36 - 897
ECSS340102901B	37PFR116	MWDM 2L 37P 5C3 1 - 897	ECSS340102901B	37SFR116	MWDM 2L 37S 5C3 1 - 897
ECSS340102902B	37PFR116	MWDM 5L 37P 5C3 1 - 897	ECSS340102902B	37SFR116	MWDM 5L 37S 5C3 1 - 897

Mod code 897 applied to all connector part numbers. Complies with the test and screening requirements of ESCC 3401-029 level B and ESCC 3401



SPACE-GRADE MICRO-D CONNECTORS

MWDM Micro-D pigtail wire connectors



ESA to Glenair Part Number cross-reference

Micro-D 51 Way Pin			Micro-D 51 Way Socket		
ESA Basic Number	Variant no.	Glenair Part Number	ESA Basic Number	Variant no.	Glenair Part Number
ECSS340102901B	51PFR112	MWDM 2L 51P 6M1 20 - 897	ECSS340102901B	51SFR112	MWDM 2L 51S 6M1 20 - 897
ECSS340102902B	51PFR112	MWDM 5L 51P 6M1 20 - 897	ECSS340102902B	51SFR112	MWDM 5L 51S 6M1 20 - 897
ECSS340102901B	51PFR112A	MWDM 2L 51P 6G2 20 - 897	ECSS340102901B	51SFR112A	MWDM 2L 51S 6G2 20 - 897
ECSS340102902B	51PFR112A	MWDM 5L 51P 6G2 20 - 897	ECSS340102902B	51SFR112A	MWDM 5L 51S 6G2 20 - 897
ECSS340102901B	51PFR113	MWDM 2L 51P 6M1 36 - 897	ECSS340102901B	51SFR113	MWDM 2L 51S 6M1 36 - 897
ECSS340102902B	51PFR113	MWDM 5L 51P 6M1 36 - 897	ECSS340102902B	51SFR113	MWDM 5L 51S 6M1 36 - 897
ECSS340102901B	51PFR113A	MWDM 2L 51P 6G2 36 - 897	ECSS340102901B	51SFR113A	MWDM 2L 51S 6G2 36 - 897
ECSS340102902B	51PFR113A	MWDM 5L 51P 6G2 36 - 897	ECSS340102902B	51SFR113A	MWDM 5L 51S 6G2 36 - 897
ECSS340102901B	51PFR123	MWDM 2L 51P 6M1 158 - 897	ECSS340102901B	51SFR123	MWDM 2L 51S 6M1 158 - 897
ECSS340102902B	51PFR123	MWDM 5L 51P 6M1 158 - 897	ECSS340102902B	51SFR123	MWDM 5L 51S 6M1 158 - 897
ECSS340102901B	51PFR123A	MWDM 2L 51P 6G2 158 - 897	ECSS340102901B	51SFR123A	MWDM 2L 51S 6G2 158 - 897
ECSS340102902B	51PFR123A	MWDM 5L 51P 6G2 158 - 897	ECSS340102902B	51SFR123A	MWDM 5L 51S 6G2 158 - 897
ECSS340102901B	51PFR114	MWDM 2L 51P 8M1 20 - 897	ECSS340102901B	51SFR114	MWDM 2L 51S 8M1 20 - 897
ECSS340102902B	51PFR114	MWDM 5L 51P 8M1 20 - 897	ECSS340102902B	51SFR114	MWDM 5L 51S 8M1 20 - 897
ECSS340102901B	51PFR115	MWDM 2L 51P 8M1 36 - 897	ECSS340102901B	51SFR115	MWDM 2L 51S 8M1 36 - 897
ECSS340102902B	51PFR115	MWDM 5L 51P 8M1 36 - 897	ECSS340102902B	51SFR115	MWDM 5L 51S 8M1 36 - 897
ECSS340102901B	51PFR116	MWDM 2L 51P 5C3 1 - 897	ECSS340102901B	51SFR116	MWDM 2L 51S 5C3 1 - 897
ECSS340102902B	51PFR116	MWDM 5L 51P 5C3 1 - 897	ECSS340102902B	51SFR116	MWDM 5L 51S 5C3 1 - 897

Mod code 897 applied to all connector part numbers. Complies with the test and screening requirements of ESCC 3401-029 level B and ESCC 3401

A

SPACE-GRADE MICRO-D CONNECTORS

MWDM Micro-D solder cup connectors

to ESCC3401-029 and MIL-DTL-83513

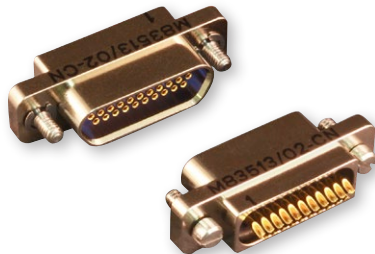
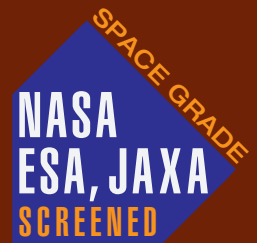

FEATURES

- High-quality TwistPin contact system
- MIL-DTL-83513 qualified
- Process and control according to ESCC3401-071 and 3401-029
- Screened to ESA or NASA operational standards
- Manufactured in the EU

How To Order Solder Cup Connectors								
Sample Part Number	MWDM	2	L	-15	P	S	B	-897B
Series	MWDM Glenair Micro-D							
Shell Material and Finish	Aluminum Shell 2 - Nickel 5 - Gold							
Insulator Material	L - LCP - 30% Glass-Filled Liquid Crystal Polymer							
Contact Layout	9, 15, 21, 25, 31, 37 Cavities							
Contact Type	P - Pin S - Socket							
Termination Type	S - Solder Cup (Size #26 solder cup contacts)							
Hardware	B - No hardware (ordered separately, see next page)							
Screening Mod Codes	-429 (NASA) -897 (ESA) Omit for no screening required (see table below)							

A

ESA and NASA Screening Levels and Modification Codes				
Screening Level	Special Screening Only		Special Screening Plus Outgassing Processing	
	Interfacial Seal is Installed	Interfacial Seal is Deleted	48 Hour Oven Bake 175° C	Thermal Vacuum Outgassing 24 hrs. 125° C
ESA Level 1 Highest Reliability	Mod Code 897E	Mod Code 897F	Mod Code 897J	Mod Code 897C
ESA Level 2 High Reliability	Mod Code 897B	Mod Code 897D	Mod Code 897K	Mod Code 897A
ESA Level 3 Standard Reliability	Mod Code 897	Mod Code 432	Mod Code 186	Mod Code 186M
NASA Level 1 Highest Reliability	Mod Code 429B	Mod Code 429F	Mod Code 429J	Mod Code 429C
NASA Level 2 High Reliability	Mod Code 429	Mod Code 429D	Mod Code 429K	Mod Code 429A
NASA Level 3 Standard Reliability	(Use standard part number)	Mod Code 432	Mod Code 186	Mod Code 186M

DIMENSIONS / WEIGHTS

Dimensions and other options are available in the *Glenair High-Performance Micro-D Connectors and Cables* catalog, page B-8. Weights according to ESCC 3401-029.

SCREENING

Add Mod Code -897 after the part number for ESA screening.
Add Mod Code -429 for NASA EEE-INS-002 screening.

SPACE-GRADE MICRO-D CONNECTOR HARDWARE

MWDM Micro-D hardware

for pigtail wire and solder cup connectors

to ESCC3901-032



TYPE 07 C-CLIP JACKSCREW KITS

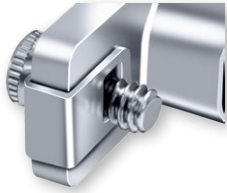

C Clip Jackscrew Kits offer an alternative to e-ring jackscrew kits. The c clip fits over the flange and, unlike e-rings, cannot be dislodged in handling or use. Order Two Kits Per Connector. Each kit consists of one jackscrew and one c clip. The clip is made from 17-7PH spring temper stainless steel. The jackscrew is made from 125 KPSI tensile strength stainless steel, passivated. *Note:* The magnetic permeability of the c clip exceeds the 2.0 μ maximum of MIL-DTL-83513.

Part Number	Jackscrew Type	Thread Size	Configuration	Recommended Max.Torque	Max. Weight In Grams (2 Kits)
179-013-1S	Slot Head	#2-56 UNC	Figure 1	2.5 inch-pounds	1.0

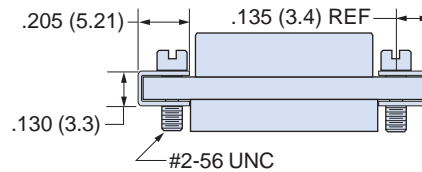

Figure 1
C Clip for Size 9 - 69 Pin Micro-D

TYPE 08 JACKPOST KITS

Standard kits for installation on all standard Micro-D connectors. Each kit contains two jackposts, two hex nuts and two lockwashers.

Connector Sizes (THDS)	Glenair Part Number	A Length		Figure
		In. $\pm .015$	mm. ± 0.4	
9 — 51	080-00-00-100	.475	12.1	Figure 1

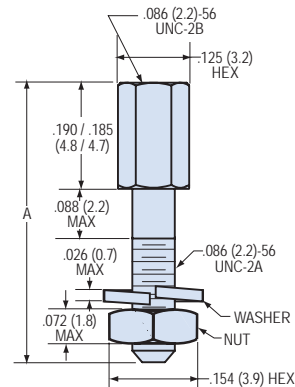

Figure 1
#2-56 Jackpost

SPACE-GRADE MICRO-D CONNECTOR HARDWARE

MWDM Micro-D hardware

for pigtail wire and solder cup connectors

to ESCC3901-032

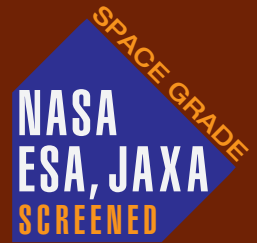

TYPE 09 JACKPOST KITS FOR REAR-MOUNTED CONNECTORS

For rear panel mounted connectors. These round, slotted posts accommodate panel thickness from .031 inches (0.8 mm.) to .125 inches (3.2 mm.).

Connector Size (THDS)	Panel Thickness		Part Number	A		Figure
	In.	mm		In. ± .003	mm. ± 0.08	
9 — 51	.031	0.8	177-504-2-2	.024	0.61	Figure 1
	.062	1.6	177-504-2-4	.055	1.40	

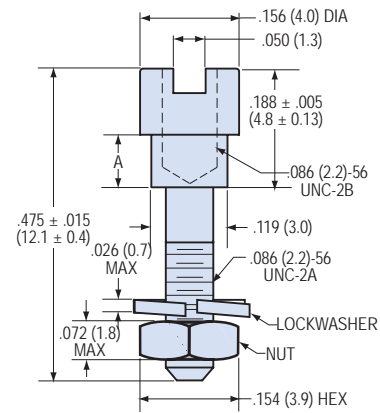

Figure 1
#2-56 Jackpost



ESA PART NO. TRANSLATED TO GLENAIR EQUIVALENT PART NUMBER

How to order ESCC3401-037 hardware.	
ESA Basic P/N	Glenair P/N
ESCC 3401 032, type 07	179-013-1S (9-51 way)
ESCC 3401 032, type 08	080-00-00-100 (9-51 way)
ESCC 3401 032, type 09	177-504-2-4 (9-51 way)

SPACE-GRADE MICRO-D CONNECTORS

GMR 7580 Micro-D

vertical-mount PCB connectors

to ESCC3401-029

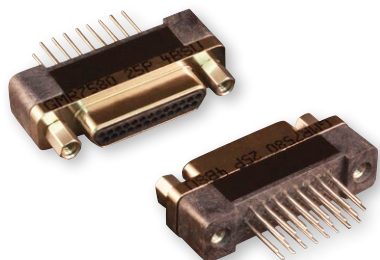

FEATURES

- High-quality TwistPin contact system
- Based on MIL-DTL-83513 qualified parts
- Compact design
- M2 threaded mounting inserts standard
- Screened to ESA or NASA operational standards
- Manufactured in the EU

A

How To Order PCB Mount Connectors								
Sample Part Number	GMR7580	-15	S	3	5	SM	-513	-897B
Series	GMR7580 Glenair Micro-D vertical mount							
Contact Layout	9, 15, 21, 25, 31, 37, 51, 69, 100, Cavities							
Contact Type	P - Pin S - Socket							
Termination Length in Inches	3 - (4.83 nominal)							
Shell Material and Finish	Aluminum Shell 2 - Nickel 5 - Gold							
Jackpost Option	SM - Short jackpost VM - Rear panel mount jackpost, panel thickness 1.6mm							
Gold-Plated Terminals	-513 - for gold-plated terminals Omit - for standard							
Screening Mod Codes	-429 (NASA) -897 (ESA) Omit for no screening required (see table next page)							

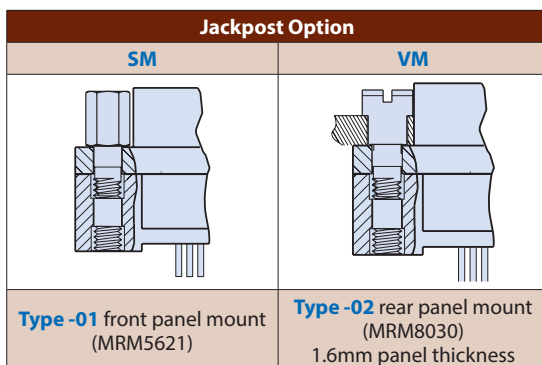

How to order ESCC3401-037 hardware	
ESA Basic P/N	Glenair P/N
ESCC 3401 032, type 01	MRM 5621
ESCC 3401 032, type 02	MRM 8030

DIMENSIONS / WEIGHTS

Dimensions and other options are available in the *Glenair High-Performance Micro-D Connectors and Cables* catalog, page C-32. Weights according to ESCC 3401-029.

SCREENING

Add Mod Code -897 after the part number for ESA screening.
Add Mod Code -429 for NASA EEE-INS-002 screening.

SPACE-GRADE MICRO-D CONNECTORS

GMR 7580 Micro-D

vertical-mount PCB connectors

ESA to Glenair Part Number cross-reference

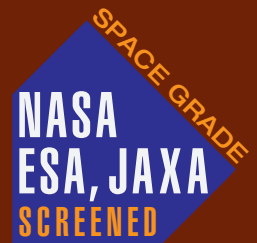

ESA and NASA Screening Levels and Modification Codes				
Screening Level	Special Screening Only		Special Screening Plus Outgassing Processing	
	Interfacial Seal is Installed	Interfacial Seal is Deleted	48 Hour Oven Bake 175° C	Thermal Vacuum Outgassing 24 hrs. 125° C
ESA Level 1 Highest Reliability	Mod Code 897E	Mod Code 897F	Mod Code 897J	Mod Code 897C
ESA Level 2 High Reliability	Mod Code 897B	Mod Code 897D	Mod Code 897K	Mod Code 897A
ESA Level 3 Standard Reliability	Mod Code 897	Mod Code 432	Mod Code 186	Mod Code 186M
NASA Level 1 Highest Reliability	Mod Code 429B	Mod Code 429F	Mod Code 429J	Mod Code 429C
NASA Level 2 High Reliability	Mod Code 429	Mod Code 429D	Mod Code 429K	Mod Code 429A
NASA Level 3 Standard Reliability	(Use standard part number)	Mod Code 432	Mod Code 186	Mod Code 186M

GMR7580 PCB mount Pin connectors			GMR7580 PCB mount Socket connectors		
ESA Basic Number	Variant no.	Glenair Part Number	ESA Basic Number	Variant no.	Glenair Part Number
ECSS340102901B	9PGMR7580	GMR7580-9P3BNM-513-897	ECSS340102901B	9SGMR7580	GMR7580-9S3BNM-513-897
ECSS340102902B	9PGMR7580	GMR7580-9P3ENM-513-897	ECSS340102902B	9SGMR7580	GMR7580-9S3ENM-513-897
ECSS340102901B	15PGMR7580	GMR7580-15P3BNM-513-897	ECSS340102901B	15SGMR7580	GMR7580-15S3BNM-513-897
ECSS340102902B	15PGMR7580	GMR7580-15P3ENM-513-897	ECSS340102902B	15SGMR7580	GMR7580-15S3ENM-513-897
ECSS340102901B	21PGMR7580	GMR7580-21P3BNM-513-897	ECSS340102901B	21SGMR7580	GMR7580-21S3BNM-513-897
ECSS340102902B	21PGMR7580	GMR7580-21P3ENM-513-897	ECSS340102902B	21SGMR7580	GMR7580-21S3ENM-513-897
ECSS340102901B	25PGMR7580	GMR7580-25P3BNM-513-897	ECSS340102901B	25SGMR7580	GMR7580-25S3BNM-513-897
ECSS340102902B	25PGMR7580	GMR7580-25P3ENM-513-897	ECSS340102902B	25SGMR7580	GMR7580-25S3ENM-513-897
ECSS340102901B	31PGMR7580	GMR7580-31P3BNM-513-897	ECSS340102901B	31SGMR7580	GMR7580-31S3BNM-513-897
ECSS340102902B	31PGMR7580	GMR7580-31P3ENM-513-897	ECSS340102902B	31SGMR7580	GMR7580-31S3ENM-513-897
ECSS340102901B	37PGMR7580	GMR7580-37P3BNM-513-897	ECSS340102901B	37SGMR7580	GMR7580-37S3BNM-513-897
ECSS340102902B	37PGMR7580	GMR7580-37P3ENM-513-897	ECSS340102902B	37SGMR7580	GMR7580-37S3ENM-513-897
ECSS340102901B	51PGMR7580	GMR7580-51P3BNM-513-897	ECSS340102901B	51SGMR7580	GMR7580-51S3BNM-513-897
ECSS340102902B	51PGMR7580	GMR7580-51P3ENM-513-897	ECSS340102902B	51SGMR7580	GMR7580-51S3ENM-513-897
ECSS340102901B	69PGMR7580	GMR7580-69P3BNM-513-897	ECSS340102901B	69SGMR7580	GMR7580-69S3BNM-513-897
ECSS340102902B	69PGMR7580	GMR7580-69P3ENM-513-897	ECSS340102902B	69SGMR7580	GMR7580-69S3ENM-513-897
ECSS340102901B	100PGMR7580	GMR7580-100P3BNM-513-897	ECSS340102901B	100SGMR7580	GMR7580-100S3BNM-513-897
ECSS340102902B	100PGMR7580	GMR7580-100P3ENM-513-897	ECSS340102902B	100SGMR7580	GMR7580-100S3ENM-513-897

Mod code 897 applied to all connector part numbers. Complies with the test and screening requirements of ESCC 3401-029 level B and ESCC 3401



SPACE-GRADE MICRO-D CONNECTORS

GMR 7590 Micro-D

right angle-mount PCB connectors

to ESCC3401-029

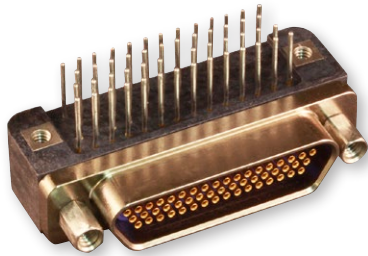

FEATURES

- High-quality TwistPin contact system
- Based on MIL-DTL-83513 qualified parts
- Compact design
- M2 threaded mounting inserts standard
- Screened to ESA or NASA operational standards
- Manufactured in the EU

A

How To Order PCB Mount Connectors								
Sample Part Number	GMR7590	-15	S	3	5	SM	-513	-897B
Series	GMR7590 Glenair Micro-D right angle mount							
Contact Layout	9, 15, 21, 25, 31, 37, 51, 69, 100 , Cavities							
Contact Type	P - Pin S - Socket							
Termination Length in Inches	3 - (4.83 nominal)							
Shell Material and Finish	Aluminum Shell 2 - Nickel 5 - Gold							
Jackpost Option	SM - Short jackpost VM - Rear panel mount jackpost, panel thickness 1.6mm							
Gold-Plated Terminals	-513 - for gold-plated terminals Omit - for standard (60/40 tin-lead solder)							
Screening Mod Codes	-429 (NASA) -897 (ESA) Omit for no screening required (see table next page)							

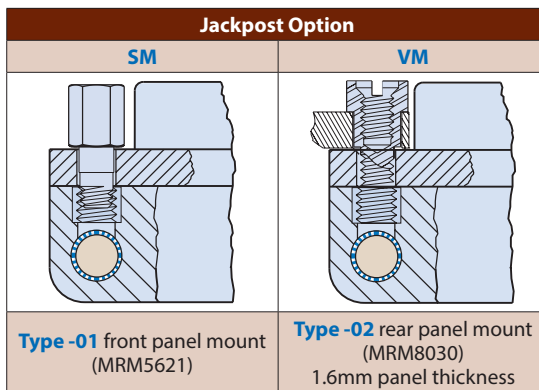

How to order ESCC3401-037 hardware	
ESA Basic P/N	Glenair P/N
ESCC 3401 032, type 01	MRM5621
ESCC 3401 032, type 02	MRM8030

DIMENSIONS / WEIGHTS

Dimensions and other options are available in the *Glenair High-Performance Micro-D Connectors and Cables* catalog, page C-36. Weights according to ESCC 3401-029.

SCREENING

Add Mod Code -897 after the part number for ESA screening.
Add Mod Code -429 for NASA EEE-INS-002 screening.

SPACE-GRADE MICRO-D CONNECTORS

GMR 7590 Micro-D

right angle-mount PCB connectors

ESA to Glenair Part Number cross-reference

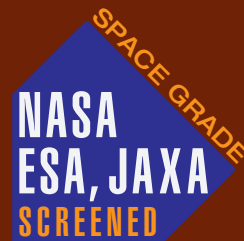

ESA and NASA Screening Levels and Modification Codes				
Screening Level	Special Screening Only		Special Screening Plus Outgassing Processing	
	Interfacial Seal is Installed	Interfacial Seal is Deleted	48 Hour Oven Bake 175° C	Thermal Vacuum Outgassing 24 hrs. 125° C
ESA Level 1 Highest Reliability	Mod Code 897E	Mod Code 897F	Mod Code 897J	Mod Code 897C
ESA Level 2 High Reliability	Mod Code 897B	Mod Code 897D	Mod Code 897K	Mod Code 897A
ESA Level 3 Standard Reliability	Mod Code 897	Mod Code 432	Mod Code 186	Mod Code 186M
NASA Level 1 Highest Reliability	Mod Code 429B	Mod Code 429F	Mod Code 429J	Mod Code 429C
NASA Level 2 High Reliability	Mod Code 429	Mod Code 429D	Mod Code 429K	Mod Code 429A
NASA Level 3 Standard Reliability	(Use standard part number)	Mod Code 432	Mod Code 186	Mod Code 186M

GMR7590 PCB mount Pin connectors			GMR7590 PCB mount Socket connectors		
ESA Basic Number	Variant no.	Glenair Part Number	ESA Basic Number	Variant no.	Glenair Part Number
ECSS340102901B	9PGMR7590	GMR7590-9P3BNM-513-897	ECSS340102901B	9SGMR7590	GMR7590-9S3BNM-513-897
ECSS340102902B	9PGMR7590	GMR7590-9P3ENM-513-897	ECSS340102902B	9SGMR7590	GMR7590-9S3ENM-513-897
ECSS340102901B	15PGMR7590	GMR7590-15P3BNM-513-897	ECSS340102901B	15SGMR7590	GMR7590-15S3BNM-513-897
ECSS340102902B	15PGMR7590	GMR7590-15P3ENM-513-897	ECSS340102902B	15SGMR7590	GMR7590-15S3ENM-513-897
ECSS340102901B	21PGMR7590	GMR7590-21P3BNM-513-897	ECSS340102901B	21SGMR7590	GMR7590-21S3BNM-513-897
ECSS340102902B	21PGMR7590	GMR7590-21P3ENM-513-897	ECSS340102902B	21SGMR7590	GMR7590-21S3ENM-513-897
ECSS340102901B	25PGMR7590	GMR7590-25P3BNM-513-897	ECSS340102901B	25SGMR7590	GMR7590-25S3BNM-513-897
ECSS340102902B	25PGMR7590	GMR7590-25P3ENM-513-897	ECSS340102902B	25SGMR7590	GMR7590-25S3ENM-513-897
ECSS340102901B	31PGMR7590	GMR7590-31P3BNM-513-897	ECSS340102901B	31SGMR7590	GMR7590-31S3BNM-513-897
ECSS340102902B	31PGMR7590	GMR7590-31P3ENM-513-897	ECSS340102902B	31SGMR7590	GMR7590-31S3ENM-513-897
ECSS340102901B	37PGMR7590	GMR7590-37P3BNM-513-897	ECSS340102901B	37SGMR7590	GMR7590-37S3BNM-513-897
ECSS340102902B	37PGMR7590	GMR7590-37P3ENM-513-897	ECSS340102902B	37SGMR7590	GMR7590-37S3ENM-513-897
ECSS340102901B	51PGMR7590	GMR7590-51P3BNM-513-897	ECSS340102901B	51SGMR7590	GMR7590-51S3BNM-513-897
ECSS340102902B	51PGMR7590	GMR7590-51P3ENM-513-897	ECSS340102902B	51SGMR7590	GMR7590-51S3ENM-513-897
ECSS340102901B	69PGMR7590	GMR7590-69P3BNM-513-897	ECSS340102901B	69SGMR7590	GMR7590-69S3BNM-513-897
ECSS340102902B	69PGMR7590	GMR7590-69P3ENM-513-897	ECSS340102902B	69SGMR7590	GMR7590-69S3ENM-513-897
ECSS340102901B	100PGMR7590	GMR7590-100P3BNM-513-897	ECSS340102901B	100SGMR7590	GMR7590-100S3BNM-513-897
ECSS340102902B	100PGMR7590	GMR7590-100P3ENM-513-897	ECSS340102902B	100SGMR7590	GMR7590-100S3ENM-513-897

Mod code 897 applied to all connector part numbers. Complies with the test and screening requirements of ESCC 3401-029 level B and ESCC 3401



SPACE-GRADE MICRO-D BACKSHELLS

MWDM Micro-D straight top-entry backshells

for ESCC3401-029 connectors



FEATURES

- Thin wall, lightweight construction
- Stable one-piece design
- Close tolerance for improved shielding
- Machined non-porous material
- Extensive space flight heritage
- Manufactured in the EU

A

How To Order Straight Entry Backshells								
Sample Part Number	GMB	-T	-S	-15	-20	-00	-5	-C
Series	GMB - Space-grade Micro-D backshell							
Backshell Type	T - Top entry							
Cable Entry	S - Single D - Double							
Backshell Size	9, 15, 21, 25, 31, 37, 51, 69, 100, Cavities							
Cable Entry Code, Entry 1	See Table III							
Cable Entry Code, Entry 2	See Table III (Omit for single entry)							
Backshell Material and Finish	Aluminum Shell 2 - Electroless Nickel 5 - Gold							
Termination Option	C - Crimp B - Band (Crimp Ring or Band-Master™ ATS band supplied with the backshell) Omit - None							

No ESA specification to cover backshells for ESCC3401-029 Micro-D connectors.

Table III Cable Entry Code		
Cable Entry Code	Ø G (mm)	Ø H (mm)
06	2.30	3.80
10	3.10	4.60
13	4.00	5.50
16	4.90	6.40
20	5.60	7.10
23	6.40	7.90
26	7.00	8.50
29	7.80	9.30
30	8.30	10.30

Maximum cable entry code (Entry 1)		
Backshell/Connector Size	Maximum Cable entry Code	Max cable Bundle Diameter
09	23	Ø6.2
15	23	Ø6.2
21	23	Ø6.2
25	23	Ø6.2
31	23	Ø6.2
37	23	Ø6.2
51	26	Ø6.8
69	26	Ø6.8
100	30	Ø8.1

If wire bundle exceeds maximum cable entry use double outlet or elliptical outlet backshell

Maximum cable entry code (Entry 2)		
Backshell/Connector Size	Maximum Cable entry Code	Max cable Bundle Diameter
09	-	-
15	10	Ø2.9
21	13	Ø3.8
25	20	Ø5.4
31	23	Ø6.2
37	23	Ø6.2
51	26	Ø6.8
69	26	Ø6.8
100	29	Ø7.6

If wire bundle exceeds maximum cable entry use elliptical outlet backshell

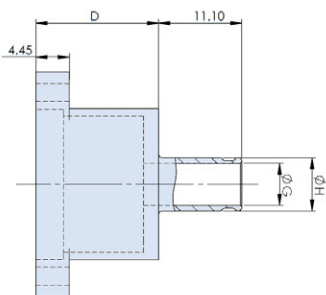

For complete dimensions and options, refer to drawings GDS223-T-D and GDS223-T-D

SPACE-GRADE MICRO-D BACKSHELLS

MWDM Micro-D 45° top-entry backshells

for ESCC3401-029 connectors

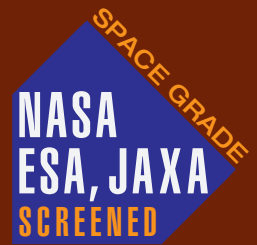

FEATURES

- Thin wall, lightweight construction
- Stable one-piece design
- Close tolerance for improved shielding
- Machined non-porous material
- Extensive space flight heritage
- Manufactured in the EU

How To Order 45° Entry Backshells							
Sample Part Number	GMB	-E	-S	-15	-20	-5	-C
Series	GMB - Space-grade Micro-D backshell						
Backshell Type	E - 45° entry						
Cable Entry	S - Single						
Backshell Size	9, 15, 21, 25, 31, 37, 51, 69, 100, Cavities						
Cable Entry Code, Entry 1	See Table III						
Backshell Material and Finish	Aluminum Shell 2 - Electroless Nickel 5 - Gold						
Termination Option	C - Crimp B - Band (Crimp Ring or Band-Master™ ATS band supplied with the backshell) Omit - None						

No ESA specification to cover backshells for ESCC3401-029 Micro-D connectors.

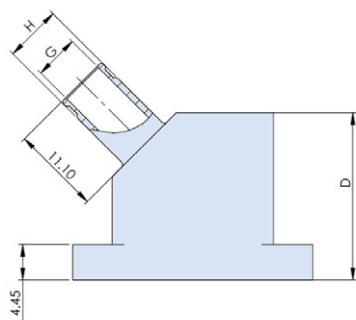

Cable Entry Code	Ø G (mm)	Ø H (mm)
06	2.30	3.80
10	3.10	4.60
13	4.00	5.50
16	4.90	6.40
20	5.60	7.10
23	6.40	7.90
26	7.00	8.50
29	7.80	9.30
30	8.30	10.30

Backshell/ Connector Size	Maximum Cable entry Code	Max cable Bundle Diameter
09	23	Ø6.2
15	23	Ø6.2
21	23	Ø6.2
25	23	Ø6.2
31	23	Ø6.2
37	23	Ø6.2
51	26	Ø6.8
69	26	Ø6.8
100	30	Ø8.1

If wire bundle exceeds maximum cable entry use double outlet backshell

For complete dimensions and options, refer to drawings GDS223-E-S

SPACE-GRADE MICRO-D BACKSHELLS

MWDM Micro-D 90° entry backshells

for ESCC3401-029 connectors



FEATURES

- Thin wall, lightweight construction
- Stable one-piece design
- Close tolerance for improved shielding
- Machined non-porous material
- Extensive space flight heritage
- Manufactured in the EU

A

How To Order 90° Entry Backshells								
Sample Part Number	GMB	-S	-S	-15	-20	-00	-5	-C
Series	GMB - Space-grade Micro-D backshell							
Backshell Type	S - Side entry							
Cable Entry	S - Single D - Double							
Backshell Size	9, 15, 21, 25, 31, 37, 51, 69, 100, Cavities							
Cable Entry Code, Entry 1	See Table III							
Cable Entry Code, Entry 2	See Table III							
Backshell Material and Finish	Aluminum Shell 2 - Electroless Nickel 5 - Gold							
Termination Option	C - Crimp B - Band (Crimp Ring or Band-Master™ ATS band supplied with the backshell) Omit - None							

No ESA specification to cover backshells for ESCC3401-029 Micro-D connectors.

Table III Cable Entry Code		
Cable Entry Code	Ø G (mm)	Ø H (mm)
06	2.30	3.80
10	3.10	4.60
13	4.00	5.50
16	4.90	6.40
20	5.60	7.10
23	6.40	7.90
26	7.00	8.50
29	7.80	9.30
30	8.30	10.30
31	10.70	12.70
32	13.70	15.70

Maximum cable entry code (Entry 1)		
Backshell/Connector Size	Maximum Cable entry Code	Max cable Bundle Diameter
09	20	Ø5.4
15	30	Ø8.1
21	30	Ø8.1
25	31	Ø10.5
31	31	Ø10.5
37	31	Ø10.5
51	31	Ø10.5
69	31	Ø10.5
100	32	Ø13.5

If wire bundle exceeds maximum cable entry use double outlet or elliptical outlet backshell

Maximum cable entry code (Entry 2)		
Backshell/Connector Size	Maximum Cable entry Code	Max cable Bundle Diameter
09	-	-
15	10	Ø2.9
21	13	Ø3.8
25	20	Ø5.4
31	20	Ø5.4
37	29	Ø7.6
51	29	Ø7.6
69	31	Ø10.5
100	31	Ø10.5

If wire bundle exceeds maximum cable entry use elliptical outlet backshell

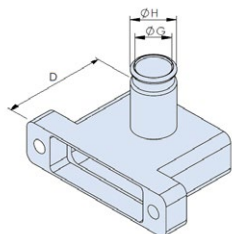

For complete dimensions and options, refer to drawings GDS223-S-S and GDS223-S-D

Famous Celestial Song Titles

Study the Night Sky...
Name all twelve



Answers revealed: May 15th 2015
www.glenair.com/qwikconnect

SPACE-GRADE MICRO-D BACKSHELLS

MWDM Micro-D elliptical straight-entry backshells

for ESCC3401-029 connectors

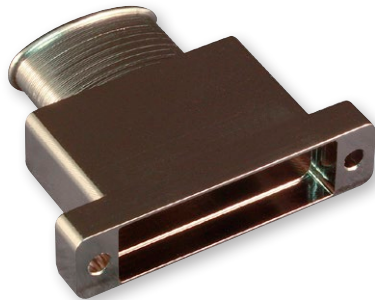
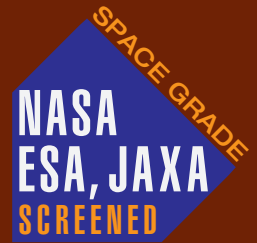

FEATURES

- Thin wall, lightweight construction
- Stable one-piece design
- Close tolerance for improved shielding
- Machined non-porous material
- Extensive space flight heritage
- Manufactured in the EU

A

How To Order 45° Entry Backshells							
Sample Part Number	GMB	-T	-E	-15	-20	-5	-C
Series	GMB - Space-grade Micro-D backshell						
Backshell Type	T - Straight (Top Entry)						
Cable Entry	E - Elliptical						
Backshell Size	9, 15, 21, 25, 31, 37, 51, 69, 100, Cavities						
Cable Entry Code, Entry 1	See Table III						
Backshell Material and Finish	Aluminum Shell 2 - Electroless Nickel 5 - Gold						
Termination Option	C - Crimp B - Band (Crimp Ring or Band-Master™ ATS band supplied with the backshell) Omit - None						

No ESA specification to cover backshells for ESCC3401-029 Micro-D connectors.

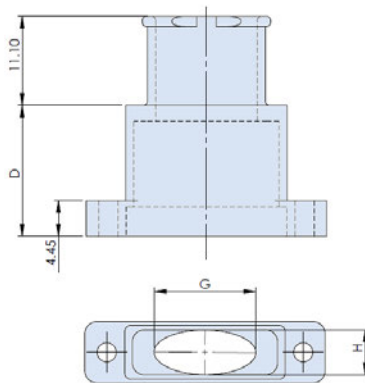

Cable Entry Code	Ø G (mm)	Ø H (mm)
01	8.4	6.1
02	12.2	6.1
03	16.0	6.1
04	18.6	6.1
05	21.4	6.1
06	25.3	6.1
07	24.9	7.2
08	26.0	8.3

Backshell/Connector Size	Maximum Cable entry Code	Max cable Bundle Diameter
09	23	Ø7.1
15	23	Ø8.5
21	23	Ø9.7
25	23	Ø10.5
31	23	Ø11.2
37	23	Ø12.2
51	26	Ø13.2
69	26	Ø13.2
100	30	Ø14.5

For complete dimensions and options, refer to drawings GDS223-T-E

SPACE-GRADE MICRO-D BACKSHELLS
Hardware for MWDM Micro-D Backshells
 for ESCC3401-029 connectors





REPLACEMENT HARDWARE KITS FOR STANDARD SERIES 50 MICRO-D BACKSHELLS



Order Two Kits Per Connector. Each Jackscrew kit consists of one jackscrew and one "C" clip.

Corrosion-Resistant Steel – The clip is made from 17-7PH spring temper stainless steel. The jackscrew is made from 300 series stainless steel, passivated.

 Fillister Head Jackscrew		 Jackpost	
Part Number	Thread Size	Part Number	Thread Size
687-152-01B	#2-56 (9-51 pin)	687-194	#2-56 (9-51 pin)

A

SPACE-GRADE GSWM Micro-D SpaceWire

Cable assemblies

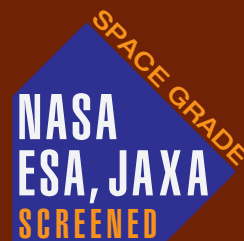

Single-Ended or Double-Ended—These easy-to-order cable assemblies eliminate the need for expensive assembly labor. 100% tested and ready for use.

High Performance Insulation—Expanded polytetrafluoroethylene (EPTFE) allows for the support of LVDS technology to significantly reduce data loss while allowing for the implementation of standard hardware protocols, thus eliminating the need for design customizations while reducing costs.

Cost saving, easy integration and high performance for flight and lab grade data transmission.

The success of any space mission begins with reliable data transmission and Glenair SpaceWire cables, built to meet the strict standards set forth by ECSS-E-ST-50-12C, make this a reality. Our SpaceWire cables offer bidirectional, high speed data transmission rates up to 400 Mbits/s while significantly reducing cross talk, skew, and signal attenuation. By incorporating a serial, point-to-point cable, with low voltage differential signaling (LVDS) reduced costs are realized through an easily integrated data transmission cable. These features allow SpaceWire cables to be incorporated across various satellite programs without the expense of costly design customization.

A

How To Order SpaceWire Cable Assembly	
Sample Part Number	GSWM 2 L -9 GP -6 F B -16 S
Product Series	GSWM Glenair SpaceWire Micro-D
Shell Plating	2 - Electroless Nickel 5 - Gold
Insulator Material	L - LCP
Shell Size	9
Connector Type	P - Single Ended Pin (Plug) GP - Pin (Plug) Connector Both Ends
Wire Gauge	6 - 26 AWG 8 - 28 AWG 0 - 30 AWG (30 AWG—Lab Only)
Cable Type	F - Flight Grade L - Lab Grade
Termination Option	B - Backshell
Cable Length In Inches	16 - 16 inches (12 inches minimum)
Hardware	S - Male Slotted Jackscrew P - Female Jackpost

Cable assemblies

A

Back To Back Wiring
Diagram (GP)

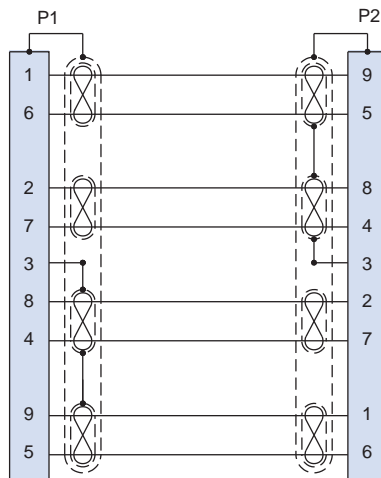

Single Ended Wiring
Diagram (P)

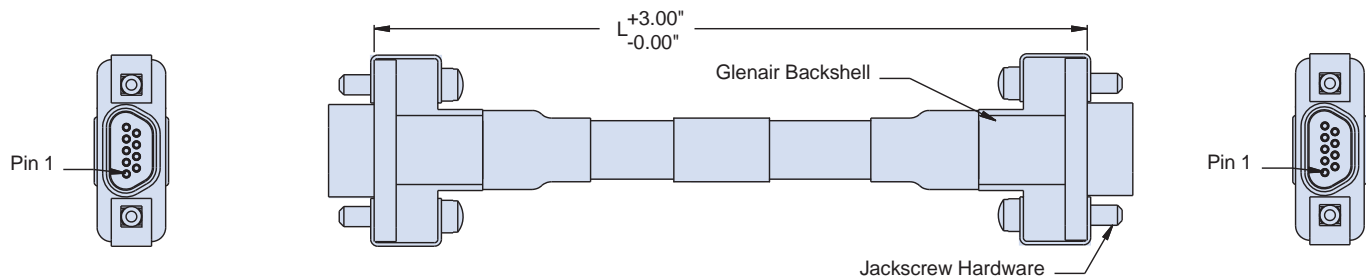
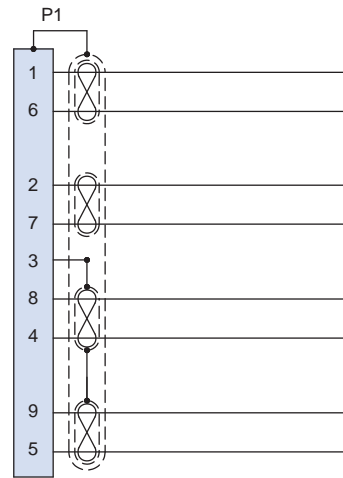

NOTES:

1. Flight grade (cable Type F) assemblies to be screened IAW NASA EEE-INST-002, Table 2. Level 1 with 100% thermal vacuum outgassing (24 hours/+125°C/10⁻⁶ torr). Reference Glenair Mod Code 429C.
2. Operating temperature - 200°C to +180°C. Reference Glenair Mod Code 428.
3. Electrical performance:
Dielectric withstanding voltage: 600 VAC.
Insulation resistance: 5000 megohms @500 VDC.
4. Assembly to be identified with Glenair's name, Part Number, Cage Code and Date Code or ESCC Component Part Marking

Standards.

MATERIALS/FINISH:

- Shells/backshells - aluminum alloy/electroless nickel.
- Insulators - high grade rigid dielectric/N.A.
- Contacts - copper alloy, gold plated.
- Hardware - stainless steel/passivated.

Nanominiature dual-row connector with flying leads

Compliant with ESCC3401-086

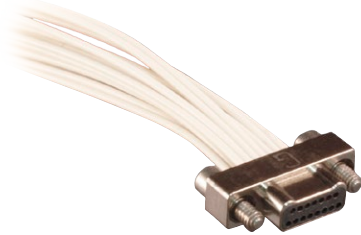
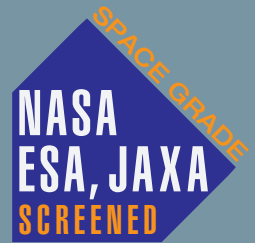

Glenair Insulated Wire Nano Connectors feature gold alloy TwistPin contacts. Contacts are precision-cripped to insulated, stranded wire. These nanominiature connectors offer premium performance and reliability for demanding applications. Contact spacing is .025 inches. 1 amp current rating, DWV rating 250 volts AC. Wire gages #30 and #32 AWG.

TwistPin Contact System assures premium performance in demanding environments. The gold/platinum alloy contacts will stand up to years of exposure without corrosion.

How to Order Nano Connectors with insulated wire compliant with ESCC3401-086

Sample Part Number	891-001	-15P	S	-0	L	1	-12	J	-897B
Series	891-001 Plug, Pin Contacts, Dual Row, Nanominiature 891-002 Receptacle, Socket Contacts, Dual Row, Nanominiature								
Insert Arrangement/ Contact Type	Plugs: 9P, 15P, 21P, 25P, 37P, 51P Receptacles: 9S, 15S, 21S, 25S, 37S, 51S								
Shell Material and Finish	A2 - Aluminum Shell, Electroless Nickel Plating S - Stainless Steel Shell, Passivated								
Wire Gage	0 - #30 AWG								
Wire Type	L - ESCC3901 012 01								
Wire Color Code	1 - White								
Wire Length Inches	12 = 12.00 + 1.00 inches (304.8mm ± 25.4mm)								
Hardware Option	J - Jackscrew T - Female Threads (for plug connectors with stainless steel shells only)								
Screening	-429 (NASA) -897 (ESA) Omit for no screening required (see "ESA and NASA Screening Levels and Modification Codes" Table on Page 10)								

B

ESCC3401-086 to Glenair P/N cross-reference

ESA Basic P/N	Glenair P/N Electroless Nickel	Glenair P/N Stainless steel
N/A	891-001-9P-A20L1-12J-897	891-001-9P-S0L1-12J-897
N/A	891-002-9S-A20L1-12T-897	891-002-9S-S0L1-12T-897
N/A	891-001-15P-A20L1-12J-897	891-001-15P-S0L1-12J-897
N/A	891-002-15S-A20L1-12T-897	891-002-15S-S0L1-12T-897
N/A	891-001-21P-A20L1-12J-897	891-001-21P-S0L1-12J-897
N/A	891-002-21S-A20L1-12T-897	891-002-21S-S0L1-12T-897
N/A	891-001-25P-A20L1-12J-897	891-001-25P-S0L1-12J-897
N/A	891-002-25S-A20L1-12T-897	891-002-25S-S0L1-12T-897
N/A	891-001-37P-A20L1-12J-897	891-001-37P-S0L1-12J-897
N/A	891-002-37S-A20L1-12T-897	891-002-37S-S0L1-12T-897
N/A	891-001-51P-A20L1-12J-897	891-001-51P-S0L1-12J-897
N/A	891-002-51S-A20L1-12T-897	891-002-51S-S0L1-12T-897

DIMENSIONS

Dimensions and other options are available in the *Glenair Series 89 Nanominiature* catalog, page E-3.

SCREENING

Add Mod Code -897 after the part number for ESA screening. Add Mod Code -429 for NASA EEE-INS-002 screening.

Nanominiature dual-row back-to-back connector

Compliant with ESCC3401-086 variant 01 and 02



Glenair Back-To-Back Nano Connectors feature gold alloy TwistPin contacts. Contacts are precision-crimped to insulated, stranded wire. These nanominiature connectors offer premium performance and reliability for demanding applications. Contact spacing is .025 inches. 1 amp current rating, DWV rating 250 volts AC. Wire gages #30 and #32 AWG.

TwistPin Contact System assures premium performance in demanding environments. The gold/platinum alloy contacts will stand up to years of exposure without corrosion.

How to Order Nano Connectors with Insulated Wire

Sample Part Number	891-005	-15	-GS	A2	-0	1	-12	J	-897B
Series	891-005 Back-to-back Nano connector								
Number of Contacts	9, 15, 21, 25, 37, 51								
Connector Type	GP - Plug (Pin) Connector on Both Ends GS - Receptacle (Socket) Connector on Both Ends CS - Plug (Pin) On One End, Receptacle On The Other End								
Shell Material and Finish	A2 - Aluminum Shell, Electroless Nickel Plating S - Stainless Steel Shell, Passivated								
Wire Gage	0 - #30 AWG								
Wire Type	L - ESCC3901 012 01B								
Wire Color Code	1 - White								
Wire Length Inches	12 = 18 inch (500mm)								
Hardware Option	JJ - Jackscrew on both plugs JT - Jackscrew on plug, threaded holes on receptacle								
Screening	-429 (NASA) -897 (ESA) Omit for no screening required (see "ESA and NASA Screening Levels and Modification Codes" Table on Page 10)								

How to order back-to-back Nano connectors according to ESCC3401-086, type 01 and 02

ESA Basic P/N	Glenair P/N
ESCC340108601B 9PPDW1950LL	891-005-9GSA2-0L1-18JJ-897
ESCC340108601B 15PPDW1950LL	891-005-15GSA2-0L1-18JJ-897
ESCC340108601B 21PPDW1950LL	891-005-21GSA2-0L1-18JJ-897
ESCC340108601B 25PPDW1950LL	891-005-25GSA2-0L1-18JJ-897
ESCC340108601B 31PPDW1950LL	891-005-31GSA2-0L1-18JJ-897
ESCC340108601B 37PPDW1950LL	891-005-37GSA2-0L1-18JJ-897
ESCC340108601B 51PPDW1950LL	891-005-51GSA2-0L1-18JJ-897
ESCC340108602B 9PSDW1950LP	891-005-9CSA2-0L1-18JT-897
ESCC340108602B 15PSDW1950LP	891-005-15CSA2-0L1-18JT-897
ESCC340108602B 21PSDW1950LP	891-005-21CSA2-0L1-18JT-897
ESCC340108602B 25PSDW1950LP	891-005-25CSA2-0L1-18JT-897
ESCC340108602B 31PSDW1950LP	891-005-31CSA2-0L1-18JT-897
ESCC340108602B 37PSDW1950LP	891-005-37CSA2-0L1-18JT-897
ESCC340108602B 51PSDW1950LP	891-005-51CSA2-0L1-18JT-897

DIMENSIONS

Dimensions and other options are available in the *Glenair Series 89 Nanominiature* catalog, page E-7.

SCREENING

Add Mod Code -897 after the part number for ESA screening. Add Mod Code -429 for NASA EEE-INS-002 screening.

Nanominiature dual-row right-angle PCB mount connector

Compliant with ESCC3401-086, variant 03

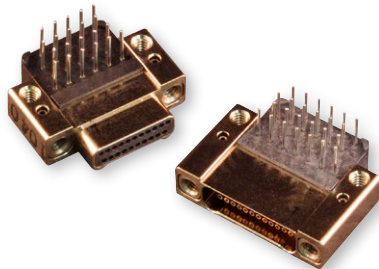
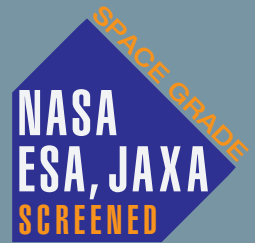

Right Angle Mount PCB Nano Connectors feature gold alloy TwistPin contacts. These nanominiature connectors offer premium performance and reliability for demanding applications. Available with female threads, or with jackscrews for use with flexible circuits.

Pre-Tinned PC Tails are coated with Sn63Pb37 or Sn60/Pb40 tin-lead for excellent solderability.

Choose Aluminum or Stainless Steel Shells in six layouts from 9 to 51 contacts. These connectors are intermateable with any corresponding Glenair Series 891 Dual row metal shell nanominiature connector.

How to Order Nano Connectors with PC tails compliant with ESCC3401-086

Sample Part Number	891-008	-15P	S	BRT	1	T	-897B
Series	891-008 Plug, Pin Contacts, Dual Row, Nanominiature 891-009 Receptacle, Socket Contacts, Dual Row, Nanominiature						
Insert Arrangement/ Contact Type	Plugs: 9P, 15P, 21P, 25P, 37P, 51P Receptacles: 9S, 15S, 21S, 25S, 37S, 51S						
Shell Material and Finish	A2 - Aluminum Shell, Electroless Nickel Plating S - Stainless Steel Shell, Passivated						
Termination Type	BRT - Board right-angle thru-hole						
PC Tail Length	1 - 2.79mm 2 - 4.37mm 3 - 3.56mm 4 - 2.29mm						
Hardware Option	J - Jackscrew T - Female Threads						
Screening	-429 (NASA) -897 (ESA) Omit for no screening required (see "ESA and NASA Screening Levels and Modification Codes" Table on Page 10)						

How to order CBR Nano connector acc. To ESCC3401-086, type 03

ESA Basic P/N	Glenair P/N
N/A	891-008-9PA2BRT3J-897
N/A	891-008-15PA2BRT3J-897
N/A	891-008-21PA2BRT3J-897
N/A	891-008-25PA2BRT3J-897
N/A	891-008-31PA2BRT3J-897
N/A	891-008-37PA2BRT3J-897
N/A	891-008-51PA2BRT3J-897
ESCC340106303B 9SCBRTT1	891-009-9SA2BRT1T-897
ESCC340106303B 15SCBRTT1	891-009-15SA2BRT1T-897
ESCC340106303B 21SCBRTT1	891-009-21SA2BRT1T-897
ESCC340106303B 25SCBRTT1	891-009-25SA2BRT1T-897
ESCC340106303B 31SCBRTT1	891-009-31SA2BRT1T-897
ESCC340106303B 37SCBRTT1	891-009-35SA2BRT1T-897
ESCC340106303B 51SCBRTT1	891-009-51SA2BRT1T-897

DIMENSIONS

Dimensions and other options are available in the *Glenair Series 89 Nanominiature* catalog, page H-7.

SCREENING

Add Mod Code -897 after the part number for ESA screening.
 Add Mod Code -429 for NASA EEE-INS-002 screening.

B

Nanominiature dual-row vertical PCB mount connector

Compliant with ESCC3401-086, variant 04

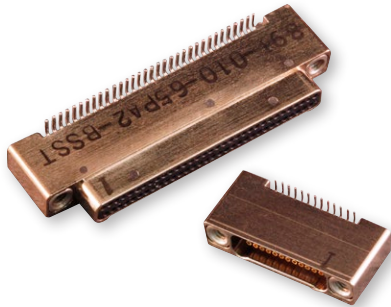

Vertical Surface Mount PCB Nano Connectors feature gold alloy TwistPin contacts. Contacts are precision-crimped #30 AWG gold-plated wire. These nanominiature connectors offer premium performance and reliability for demanding applications.

Pre-Tinned PC Tails are coated with Sn63Pb37 or Sn60/Pb40 tin-lead for excellent solderability.

Choose Aluminum or Stainless Steel Shells in six layouts from 9 to 51 contacts.

How to Order Nano Connectors with PC tails compliant with ESCC3401-086

Sample Part Number	891-010	-15P	S	BRT	T	-897B
Series	891-010 Plug, Pin Contacts, Dual Row, Nanominiature 891-011 Receptacle, Socket Contacts, Dual Row, Nanominiature					
Insert Arrangement/Contact Type	Plugs: 9P, 15P, 21P, 25P, 37P, 51P Receptacles: 9S, 15S, 21S, 25S, 37S, 51S					
Shell Material and Finish	A2 - Aluminum Shell, Electroless Nickel Plating S - Stainless Steel Shell, Passivated					
Termination Type	BSS - Board right-angle thru-hole					
Hardware Option	J - Jackscrew T - Female Threads					
Screening	-429 (NASA) -897 (ESA) Omit for no screening required (see "ESA and NASA Screening Levels and Modification Codes" Table on Page 10)					

B

How to order SMV Nano connector acc. To ESCC3401-086, type 04

ESA Basic P/N	Glenair P/N
N/A	891-010-9PA2BSSJ
N/A	891-010-15PA2BSSJ
N/A	891-010-21PA2BSSJ
N/A	891-010-25PA2BSSJ
N/A	891-010-31PA2BSSJ
N/A	891-010-37PA2BSSJ
N/A	891-010-51PA2BSSJ
ESCC340106304B 9SSMVPT1	891-011-9SA2BSST-897
ESCC340106304B 15SSMVPT1	891-011-15SA2BSST-897
ESCC340106304B 21SSMVPT1	891-011-21SA2BSST-897
ESCC340106304B 25SSMVPT1	891-011-25SA2BSST-897
ESCC340106304B 31SSMVPT1	891-011-31SA2BSST-897
ESCC340106304B 37SSMVPT1	891-011-35SA2BSST-897
ESCC340106304B 51SSMVPT1	891-011-51SA2BSST-897

DIMENSIONS

Dimensions and other options are available in the *Glenair Series 89 Nanominiature* catalog, page H-14.

SCREENING

Add Mod Code -897 after the part number for ESA screening.
 Add Mod Code -429 for NASA EEE-INS-002 screening.

Lightweight Composite Backshells

for Rectangular connectors 3401/001 and /002

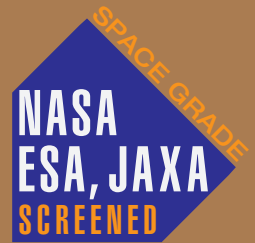

ESA/ESCC3401-072, STYLE 05-09 AND 72B

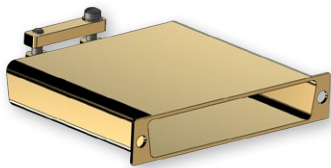

ESA/ESCC3401-072 to Glenair P/N cross-reference		
Size	ESA P/N	Glenair P/N
E	34010725B NMBA	557-433G1-1
A	34010726B NMBA	557-433G1-2
B	34010727B NMBA	557-433G1-3
C	34010728B NMBA	557-433G1-4
D	34010729B NMBA	557-433G1-5
F	340107272B NMB	557-433G1-6

For dimensions and weight see ESA/SCC3401-072, page 10

ESA/ESCC3401-072, STYLE 10-14 AND 73B, FRONT-MOUNT

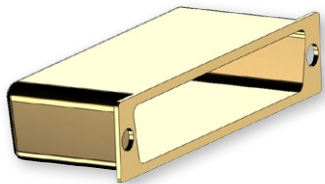

ESA/ESCC3401-072 to Glenair P/N cross-reference		
Size	ESA P/N	Glenair P/N
E	340107210B NMBA	557-434G1-1
A	340107211B NMBA	557-434G1-2
B	340107212B NMBA	557-434G1-3
C	340107213B NMBA	557-434G1-4
D	340107214B NMBA	557-434G1-5
F	340107274B NMB	557-434G1-6

For dimensions and weight see ESA/SCC3401-072, page 11

ESA/ESCC3401-072, STYLE 15-19 AND 75B, FRONT-MOUNT

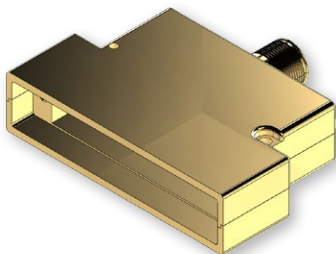

ESA/ESCC3401-072 to Glenair P/N cross-reference		
Size	ESA P/N	Glenair P/N
E	340107215B NMBA	550T072G1-1F
A	340107216B NMBA	550T072G1-2F
B	340107217B NMBA	550T072G1-3F
C	340107218B NMBA	550T072G1-4F
D	340107219B NMBA	550T072G1-5F
F	340107274B NMB	550T072G1-6F

For dimensions and weight see ESA/SCC3401-072, page 12

ESA/ESCC3401-072, STYLE 20-24 AND 76B, REAR-MOUNT

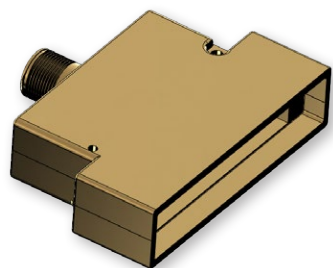

ESA/ESCC3401-072 to Glenair P/N cross-reference		
Size	ESA P/N	Glenair P/N
E	340107221B NMBA	550T072G1-1R1
A	340107221B NMBA	550T072G1-2R1
B	340107222B NMBA	550T072G1-3R1
C	340107223B NMBA	550T072G1-4R1
D	340107224B NMBA	550T072G1-5R1
F	340107275B NMB	550T072G1-6R1

For dimensions and weight see ESA/SCC3401-072, page 12

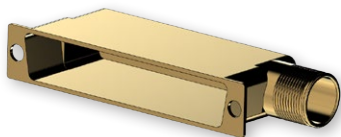
ESA/ESCC3401-072, STYLE 25-29 AND 76B, RIGHT OUTLET

ESA/ESCC3401-072 to Glenair P/N cross-reference		
Size	ESA P/N	Glenair P/N
E	34010725B NMBA	557-435G1-1R
A	34010726B NMBA	557-435G1-2R
B	34010727B NMBA	557-435G1-3R
C	34010728B NMBA	557-435G1-4R
D	34010729B NMBA	557-435G1-5R
F	340107276B NMB	557-435G1-6R

For dimensions and weight see ESA/SCC3401-072, page 13

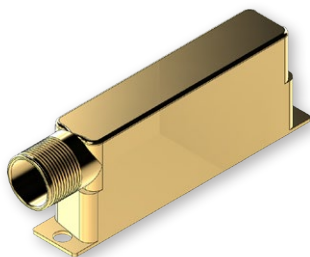
ESA/ESCC3401-072, STYLE 30-34 AND 77B, LEFT OUTLET

ESA/ESCC3401-072 to Glenair P/N cross-reference		
Size	ESA P/N	Glenair P/N
E	340107230B NMBA	557-435G1-1L
A	340107231B NMBA	557-435G1-2L
B	340107232B NMBA	557-435G1-3L
C	340107233B NMBA	557-435G1-4L
D	340107234B NMBA	557-435G1-5L
F	340107277B NMB	557-435G1-6L

For dimensions and weight see ESA/SCC3401-072, page 13

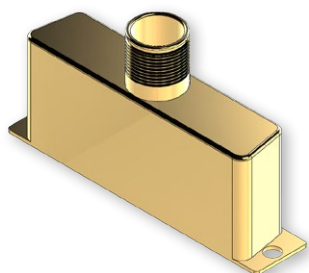
ESA/ESCC3401-072, STYLE 35-39 AND 78B, STRAIGHT OUTLET

ESA/ESCC3401-072 to Glenair P/N cross-reference		
Size	ESA P/N	Glenair P/N
E	340107235B NMBA	557-436G1-1
A	340107236B NMBA	557-436G1-2
B	340107237B NMBA	557-436G1-3
C	340107238B NMBA	557-436G1-4
D	340107239B NMBA	557-436G1-5
F	340107278B NMB	557-436G1-6

For dimensions and weight see ESA/SCC3401-072, page 14

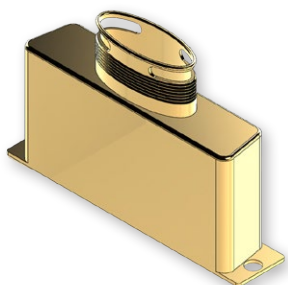
ESA/ESCC3401-072, STYLE 46-50 AND 79B, ELLIPTICAL OUTLET

ESA/ESCC3401-072 to Glenair P/N cross-reference		
Size	ESA P/N	Glenair P/N
E	340107246B NMBA	557-437G1-2
A	340107247B NMBA	687-604-1G1
B	340107248B NMBA	687-604-2G1
C	340107249B NMBA	687-604-3G1
D	340107250B NMBA	687-604-4G1
F	340107279B NMB	687-604-5G1

For dimensions and weight see ESA/SCC3401-072, page 17

Lightweight Composite Backshells

for Rectangular connectors 3401/001 and /002

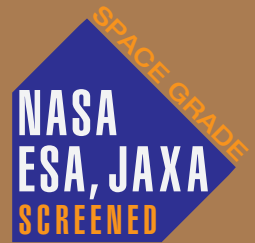

ESA/ESCC3401-072, STYLE 51-55 AND 79B, RIGHT OUTLET

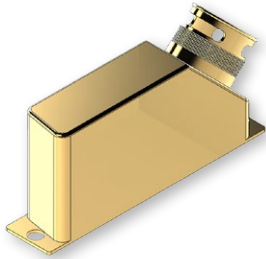

ESA/ESCC3401-072 to Glenair P/N cross-reference		
Size	ESA P/N	Glenair P/N
E	34010751B NMBA	557-436G1-1R
A	34010752B NMBA	557-436G1-2R
B	34010753B NMBA	557-436G1-3R
C	34010754B NMBA	557-436G1-4R
D	34010755B NMBA	557-436G1-5R
F	340107279B NMB	557-436G1-6R

For dimensions and weight see ESA/SCC3401-072, page 18

ESA/ESCC3401-072, STYLE 56-60 AND 80B, LEFT OUTLET

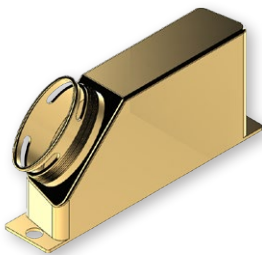

ESA/ESCC3401-072 to Glenair P/N cross-reference		
Size	ESA P/N	Glenair P/N
E	340107256B NMBA	557-436G1-1L
A	340107257B NMBA	557-436G1-2L
B	340107258B NMBA	557-436G1-3L
C	340107259B NMBA	557-436G1-4L
D	3401072360 NMBA	557-436G1-5L
F	340107279B NMB	557-436G1-6L

For dimensions and weight see ESA/SCC3401-072, page 18

ESA/ESCC3401-072, STYLE 35-39 AND 81B, STRAIGHT OUTLET

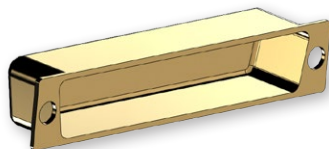

ESA/ESCC3401-072 to Glenair P/N cross-reference		
Size	ESA P/N	Glenair P/N
E	340107261B NMBA	557-440G1-1
A	340107262B NMBA	557-440G1-2
B	340107263B NMBA	557-440G1-3
C	340107264B NMBA	557-440G1-4
D	340107265B NMBA	557-440G1-5
F	340107280B NMB	557-440G1-6

For dimensions and weight see ESA/SCC3401-072, page 19

HARDWARE FOR LIGHTWEIGHT RECTANGULAR BACKSHELLS

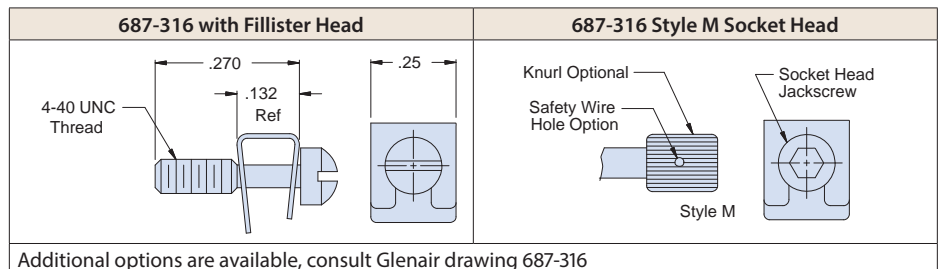
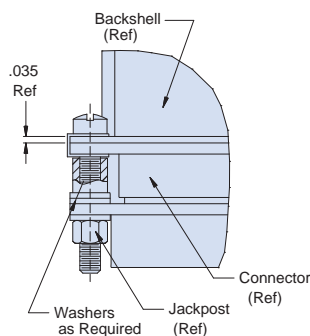

Additional options are available, consult Glenair drawing 687-316

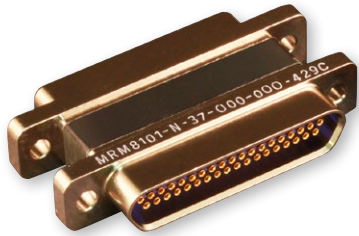

FEATURES

- High-quality TwistPin contact system
- Based on MIL-DTL-83513 qualified parts
- Per ESCC3401-041 standard
- Screened to ESA or NASA operational standards
- Manufactured in the EU

How To Order Micro-D Gender Changers			
Sample Part Number	MRM8101	-N	-9
Generic Part No.	Sav-Con Gender Changer		
Hardware	N - No hardware (order separately)		
Contact Layout	9, 15, 21, 25, 31, 37, 51, 51-2, 67, 69, 100, Cavities		

ESCC3401-041 to Glenair P/N Cross-Reference		
ESA Basic P/N	Glenair P/N	Weight, max.
340104101B9PS	MRM8101-N-9	4.0g
340104101B15PS	MRM8101-N-15	5.5g
340104101B21PS	MRM8101-N-21	7.0g
340104101B25PS	MRM8101-N-25	8.0g
340104101B31PS	MRM8101-N-31	9.5g
340104101B37PS	MRM8101-N-37	10.0g
340104101B51PS	MRM8101-N-51	13.5g
N/A	MRM8101-N-69	16.0g
N/A	MRM8101-N-100	35.0g

How to order ESCC3401-037 hardware	
ESA Basic P/N	Glenair P/N
ESCC 3401 041, variant 10	MRM17845-01 (9-69 way)
ESCC 3401 041, variant 10)*	MRM17845-02 (100 way)

*Not covered by the current issue of the ESCC3401-041 spec

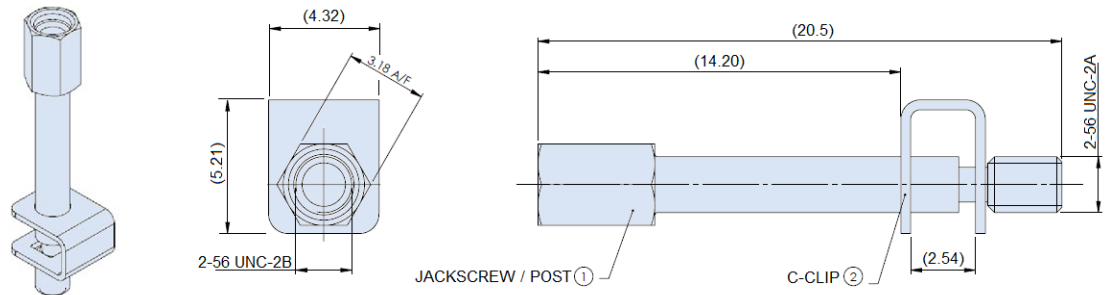

SCREENING

Add Mod Code -897 after the part number for ESA screening.
 Add Mod Code -429 for NASA EEE-INS-002 screening.

SPACE-GRADE NANOMINIATURE SAV-CON®

Nanominiature Sav-Con® connector saver

For use with ESCC3401-086 connectors

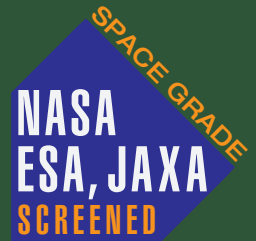

NANOMINIATURE SAV-CON®

Glenair Connector Savers protect expensive connector contacts with Glenair Connector Savers. Once installed this device will reduce wear on vital contacts and eliminate downtime due to fouled or damaged connectors.

How to Order Nano Connector Savers for ESCC3401-086 connectors

Sample Part Number	891-016	-37	S	US	P1	-897B
Series	891-016 Nanominiature Sav-Con® Connector Saver					
Number of Contacts	9, 15, 21, 25, 37, 51					
Shell Material and Finish	A2 - Aluminum Shell, Electroless Nickel Plating S - Stainless Steel Shell, Passivated					
Connector Type	US - Plug to Socket one-piece shell					
Hardware	P1 - Permanently-installed jackscrew/jackpost					
Screening	-429 (NASA) -897 (ESA) Omit for no screening required					

How to order CBR Nano connector savers according to ESCC3401-086, type 03

ESA Basic P/N	Glenair P/N
N/A	891-016 -9 US P1
N/A	891-016 -15 US P1
N/A	891-016 -21 US P1
N/A	891-016 -25 US P1
N/A	891-016 -31 US P1
N/A	891-016 -37 US P1
N/A	891-016 -51 US P1

DIMENSIONS

Dimensions and other options are available in the *Glenair Series 89 Nanominiature* catalog, page E-1.

SCREENING

Add Mod Code -897 after the part number for ESA screening.
Add Mod Code -429 for NASA EEE-INS-002 screening.

SPACE-GRADE D38999 SAV-CON® MIL-DTL-38999 Sav-Con® Connector Saver to ESCC3401-066

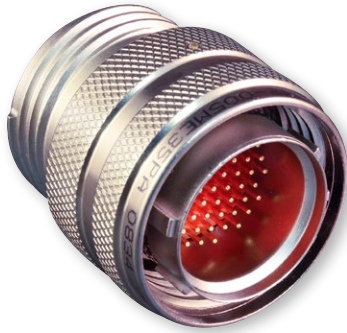

FEATURES:

- ESCC3401-063 approved for MIL-DTL-38999 Series I,II, and III Connector savers
- All standard materials and finish platings
- Environmental and hermetic designs available
- Gender changers available
- Optional locking mechanism
- Protecting equipment connectors during testing

How To Order	
Sample Part Number	942 1 -005 NF B 98 P A
Series	942 - Sav-Con® Space-Grade D38999
Class	2 = High Reliability
Basic Number	005
Finish	M - Nickel Plated
Shell Size	A=9, B=11, C=13, D=15, E=17, F=19, G=21, H=23, J=25
Insert Arrangement	Per MIL-DTL-1560
Contact Type	P = Pins, Plug Side S = Sockets, Plug Side
Alternate Key Position	A, B, C, D, E, Omit for normal

Dimensions			
Shell Size Ref	Shell Size	A Thread Class 2	B Max
A	9	.6250 - 0.1P - 0.3L - TS-2	.858 (21.82)
B	11	.7500 - 0.1P - 0.3L - TS-2	.984 (24.61)
C	13	.8750 - 0.1P - 0.3L - TS-2	1.157 (28.98)
D	15	1.0000 - 0.1P - 0.3L - TS-2	1.280 (32.16)
E	17	1.1875 - 0.1P - 0.3L - TS-2	1.406 (35.33)
F	19	1.2500 - 0.1P - 0.3L - TS-2	1.516 (38.10)
G	21	1.3750 - 0.1P - 0.3L - TS-2	1.642 (41.28)
H	23	1.5000 - 0.1P - 0.3L - TS-2	1.768 (44.45)
J	25	1.6250 - 0.1P - 0.3L - TS-2	1.890 (47.63)

How to order Savers acc. To ESCC3401-041, type 03	
ESA Basic P/N	
ESCC340106303B-9-NNP*	
ESCC340106303B-11-NNP*	
ESCC340106303B-13-NNP*	
ESCC340106303B-15-NNP*	
ESCC340106303B-17-NNP*	
ESCC340106303B-19-NNP*	
ESCC340106303B-21-NNP*	
ESCC340106303B-23-NNP*	
ESCC340106303B-25-NNP*	

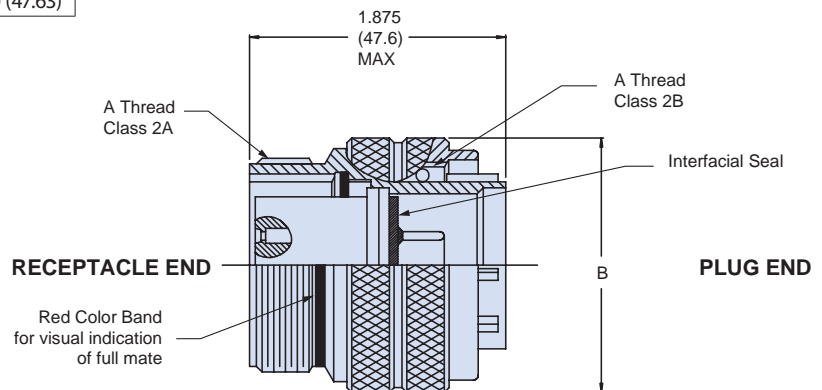

SPACE GRADE • MIL-SPEC • CIRCULAR AND RECTANGULAR Sav-Con® Connector Savers

Product family



The smart solution for preventing contact damage and extending the service life of cable assemblies and mounted receptacles

Sav-Con® connector savers protect connectors that are mated and unmated frequently during manufacturing, test, check-out phases, and environmental test programs. They prevent costly repair or replacement by absorbing connect and disconnect abuse. Glenair Sav-Con® connector savers are available for both standard and high-density insert arrangements. Popular Sav-Con® part numbers, especially for N (normal) polarization are in-stock and ready for immediate, same-day shipment. Glenair also manufactures and supplies Sav-Con® connector savers and bulkhead feed-thrus for a complete range of MS circular and rectangular connectors.

FULL RANGE OF CIRCULAR MILITARY STANDARD CONFIGURATIONS

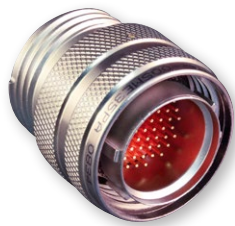

MIL-DTL-38999 Series III Type Plug/Receptacle Go-Between



MIL-DTL-38999 Series II



MIL-DTL-5015 Type



Series 80 Mighty Mouse

SAV-CON® RECTANGULAR D-SUBMINIATURE, MICRO, AND NANO MINIATURE CONNECTOR SERIES

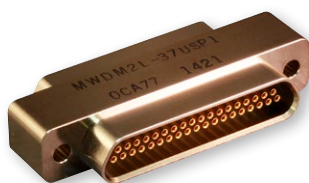

M24308 D-subminiature



Micro-D and HiPer-D™

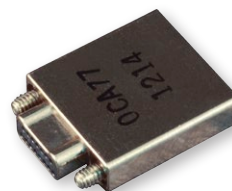

Series 89 Nanominiature

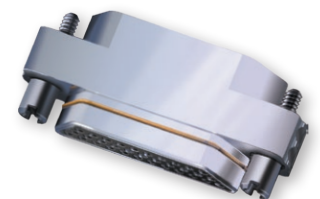

Series 79 Micro-Crimp®

SAV-CON® SPECIAL APPLICATION CONNECTOR SERIES



MIL-DTL-38999 Series III Type In-Line Gender Changer



MIL-DTL-38999 Series III Type Filtered Adapter

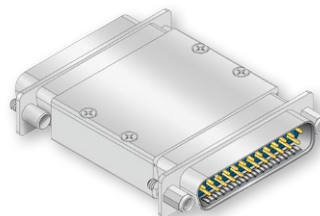

HiPer-D® Gender Changer



Micro-D Filtered Sav-Con® Adapter





ADDITIONAL SPACE-GRADE INTERCONNECT SOLUTIONS

Mission-critical interconnect technologies with proven performance—from launch systems to deep space

HIGH-RELIABILITY CABLE HARNESS ASSEMBLY

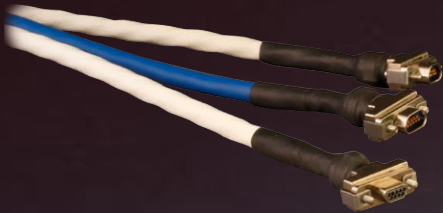

Point-to-point and complex multibranch harness assemblies that perform in even the harshest orbital and deep-space environments



SPACE-QUALIFIED HERMETIC RECEPTACLES AND BULKHEAD FEED-THRU CONNECTORS

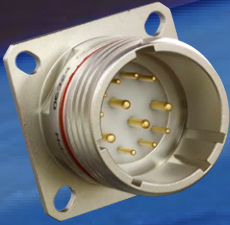

Glass-sealed circular and rectangular hermetic connectors ideal for high-pressure / low-leakage space applications

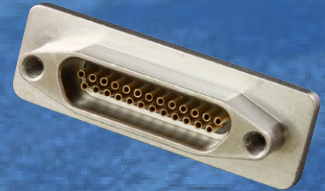
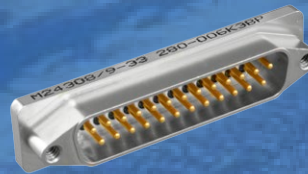

EMI/RFI FILTER CONNECTORS



MIL-DTL-38999 type, Series 80 Mighty Mouse, and other circulars



Series 28 HiPer-D and Series 79 Micro-Crimp filtered rectangulars

SPACE-GRADE MIL-DTL-83513 MICRO-D AND NANOMINIATURE CONNECTORS AND CABLES

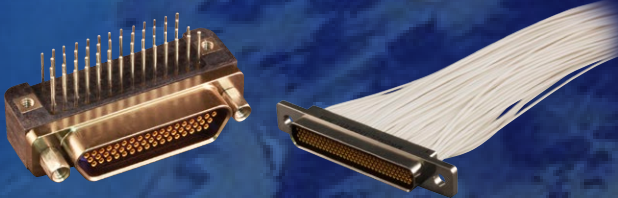

Size and weight saving MIL-DTL-83513 QPL board-mount, panel-mount, and free-cable connectors

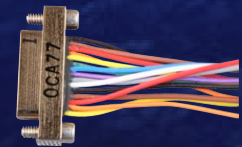
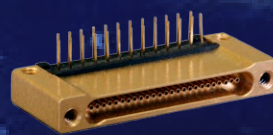

MIL-DTL-32139 QPL board-mount, panel-mount and free-cable connectors, available with outgas processing

SERIES 28 HIPER-D HIGH PERFORMANCE M24308 INTERMATEABLE D-SUB



Qualified MIL-DTL-24308 Class K Space-Grade Hermetic, environmental, filter, Sav-Con's and cordsets

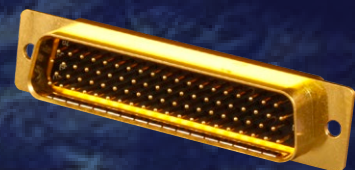

ULTRAMINIATURE SERIES 80 MIGHTY MOUSE CIRCULAR AND SERIES 79 MICRO-CRIMP RECTANGULAR

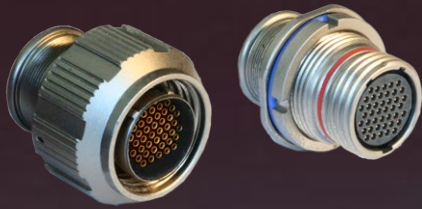

Package size, ultra light weight and contact density are ideally for Space Grade programs



A proven product, exclusively from Glenair. Ideal for guidepin and rack-and-panel applications

SAV-CON® CONNECTOR SAVERS



Available for every currently specified circular and rectangular connector series

METAL AND POLYMER CORE CONDUIT • ULTRA-LIGHTWEIGHT BRAID SOLUTIONS

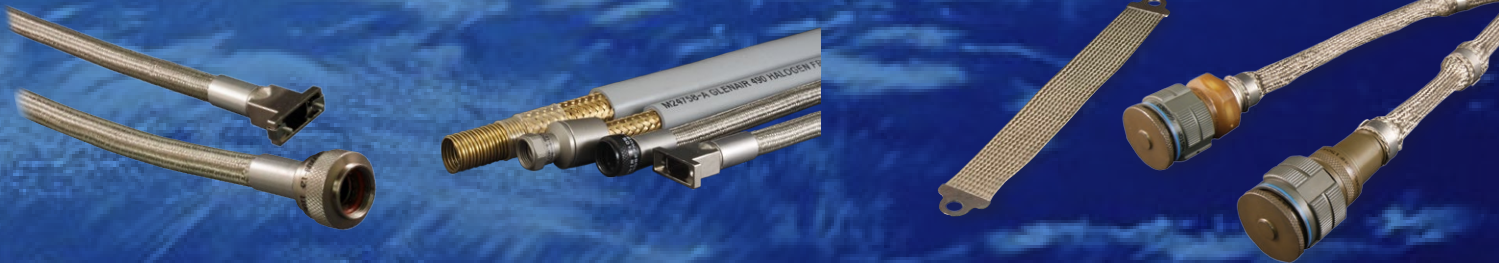

High Temperature Overbraided ETFE conduit, stainless steel metal-core conduit factory-terminated assemblies and user-installable systems

Unique weight-saving microfilament ground strap and EMI braided shielding solutions

PURPOSE-DESIGNED CIRCULAR AND RECTANGULAR BACKSHELLS AND ACCESSORIES



EMI shield termination, cable strain relief, connector protective covers and more • Lightweight composite versions

GLENAIR: NEXT-GENERATION SPACE INTERCONNECT SOLUTIONS

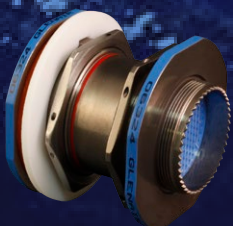

Blind-mate, assisted extraction force connectors



Lanyard-release quick-disconnect connectors



Hold-Down Release Mechanism devices

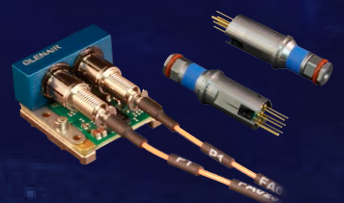

Active Optronic copper-to-fiber technology

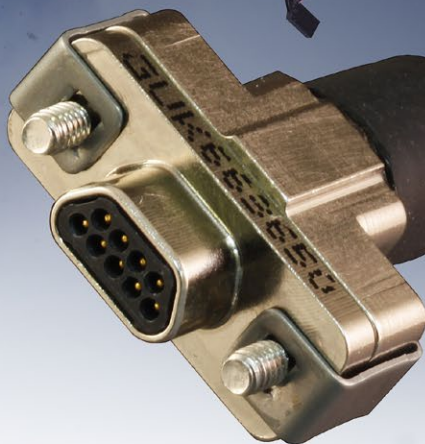
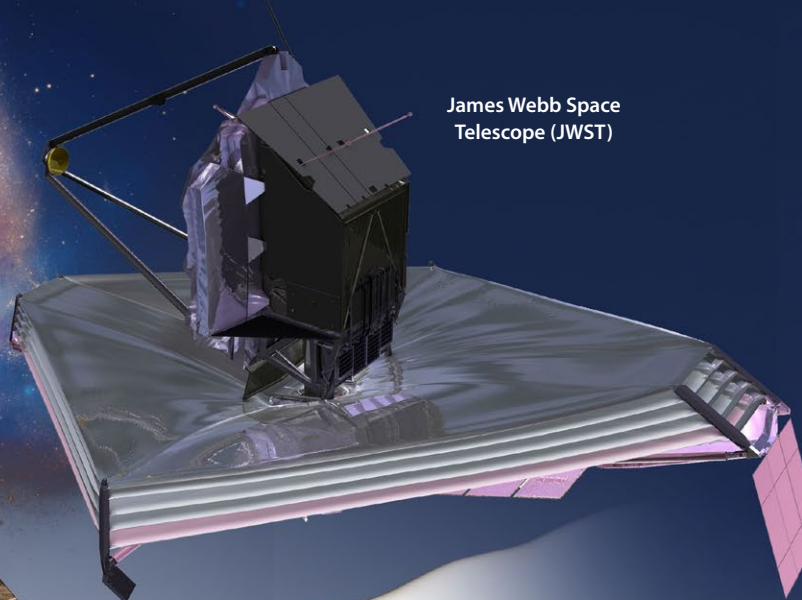

SpaceWire

Reduced cost of ownership, easy integration, and high performance for flight- and lab-grade cable assemblies

The success of any space mission begins with reliable data transmission and Glenair Spacewire cables, built to meet the strict standards set forth by ECSS-E-ST-50-12C make this a reality. Our Spacewire cables offer bidirectional, high speed data transmission rates up to 400 Mbits/s while significantly reducing cross talk, skew, and signal attenuation. By incorporating a serial, point-to-point cable, with low voltage differential signaling (LVDS) reduced costs are realized through an easily integrated data transmission cable. These features allow Spacewire cables to be incorporated across various satellite programs without the expense of costly design customization.

Spacewire: The Space Industry Data Transmission Standard Glenair Spacewire assemblies begin with a high performance cable built with expanded polytetrafluoroethylene (ePTFE) insulation. This material allows for low-loss transmission of LVDS signals, maximizing data-rates while allowing for the implementation of standard hardware protocols, thus eliminating the need for design customization and long lead time cable projects.

TYPICAL USES INCLUDE

- EGSE applications
- Radar sensor systems
- Hi-resolution camera equipment
- Sensor, mass-memory unit, and telemetry subsystem interconnections

APPROVED FOR USE BY:

- ESA
- NASA
- JAXA
- RKA

CONNECTOR/CABLE

- Laboratory and space-grade versions available
- Qualified MIL-DTL-83513 Micro-D connectors
- Gold-plated copper alloy TwistPin contacts
- Basic cable, 4 twisted pair cables and a ground
- Epoxy resin potting
- EMI banding backshell

PERFORMANCE

- 3 Amps
- Temperature tolerance -200 to 180° C
- 100 Ω impedance shielded signal pair
- Very low skew, signal attenuation and crosstalk
- 65dB minimum attenuation shielding effectiveness
- Low magnetic permeability IAW EIA-364-54

POINT-TO-POINT AND SINGLE-ENDED SpaceWire cable assemblies

Technical specifications / how-to-order

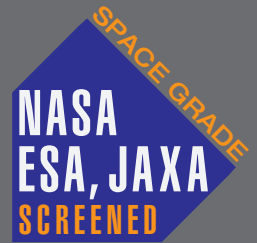

NOTES:

1. Flight grade (cable Type F) assemblies to be screened IAW NASA EEE-INST-002, Table 2. Level 1 with 100% thermal vacuum outgassing (24 hours/+125°C/10⁻⁶ torr). Reference Glenair Mod Code 429C.
2. Operating temperature - 200°C to +180°C. Reference Glenair Mod Code 428.
3. Electrical performance:
Dielectric withstanding voltage: 600 VAC.
Insulation resistance: 5000 megohms @500 VDC.
4. Assembly to be identified with Glenair's name, Part Number, Cage Code and Date Code or ESCC Component Part Marking Standards.

MATERIALS/FINISH:

- Shells/backshells - aluminum alloy/electroless nickel.
- Insulators - high grade rigid dielectric/N.A.
- Contacts - copper alloy, gold plated.
- Hardware - stainless steel/passivated.

Back To Back Wiring
Diagram (GP)

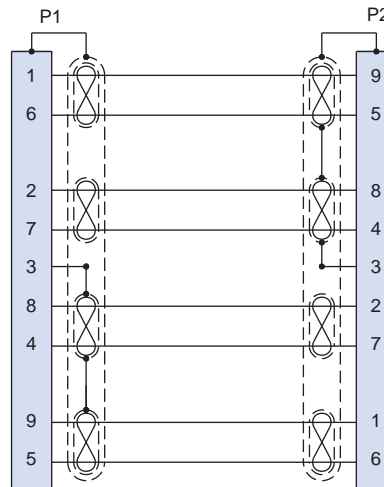

Single Ended Wiring
Diagram (P)

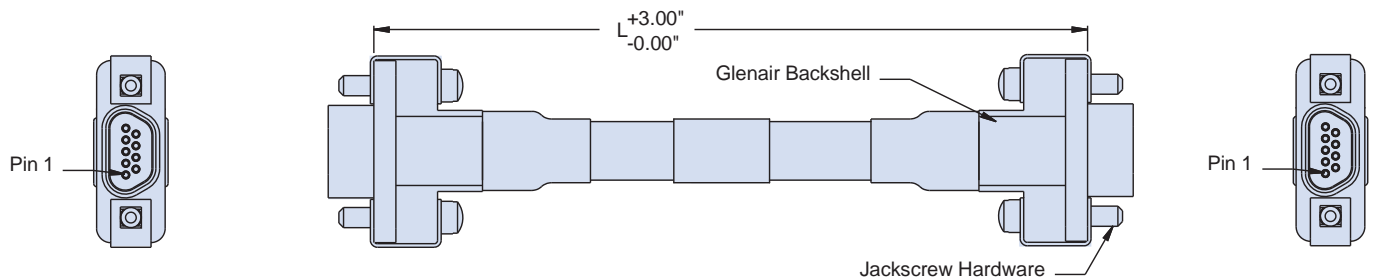
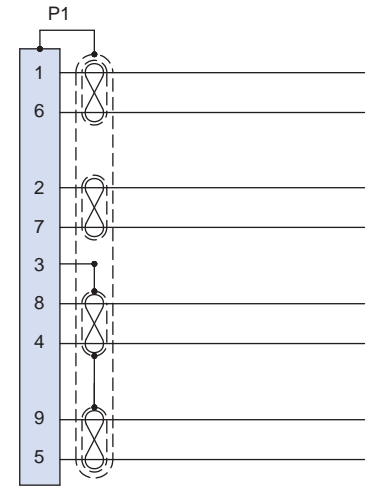

How To Order Spacewire

Sample Part Number	GSWM	2	L	-9	GP	-6	F	B	-16	S	
Product Series	GSWM—Glenair Spacewire Micro-D										
Shell Plating	2—Electroless Nickel		5—Gold								
Insulator Material	L—LCP										
Shell Size	-9										
Connector Type	P—Single Ended Pin (Plug) GP—Pin (Plug) Connector Both Ends										
Wire Gauge	-6—26 AWG			-8—28 AWG		-0—30 AWG (30 AWG—Lab Only)					
Cable Type	F—Flight Grade				L—Lab Grade						
Termination Option	B—Backshell										
Cable Length In Inches	-16 = 16 inches (12 inches minimum)										
Hardware	S—Male Slotted Jackscrew					P—Female Jackpost					



JAXA Kounotori H2
Transfer Vehicle

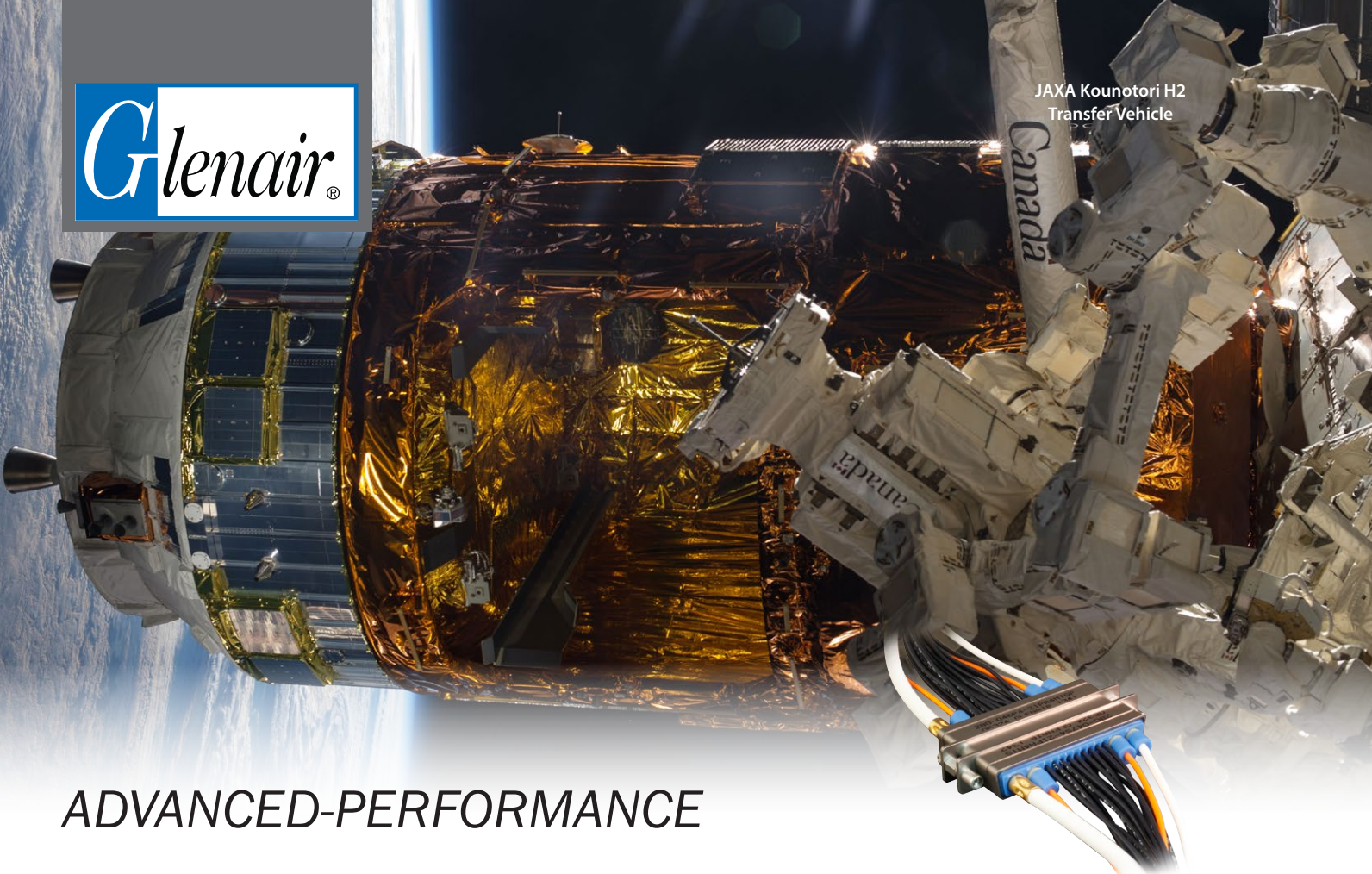

ADVANCED-PERFORMANCE

HiPer-D Connectors

High-performance M24308 intermateable

The HiPer-D connector is a M24308-type D-Subminiature connector with superior design features. Unlike standard M24308 connectors with stamped steel shells, the HiPer-D connector features a one-piece machined shell, and is rated for 200°C continuous operating temperature. Aerospace grade fluorosilicone grommets and face seals (JAXA / NASA outgassing available) provide environmental protection. The HiPer-D is intermateable, intermountable and interchangeable with standard M24308 D-Sub connectors. A ground spring offers enhanced EMI/RFI protection.

- Advanced temperature, vibration and EMC/ electrical performance
- 11 standard and 20 combo insert arrangements
- High temperature epoxy insulators
- Watertight sealing
- Rugged machined one-piece shell

STANDARD AND HIGH DENSITY CONTACT ARRANGEMENTS *(face view of pin connector)*

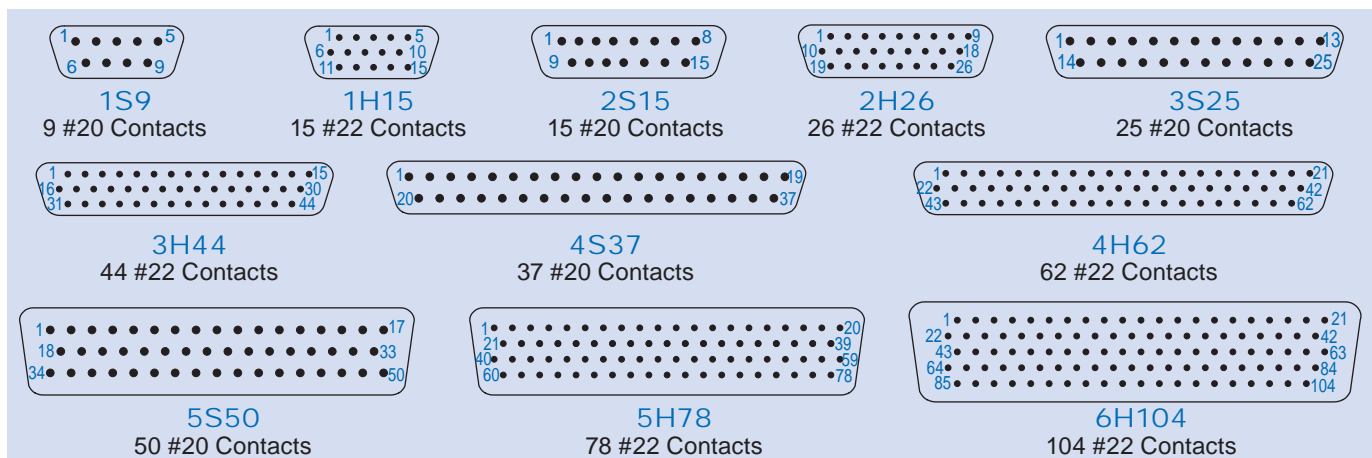

SERIES 28

HiPer-D Connectors

New Combo-D contact arrangements

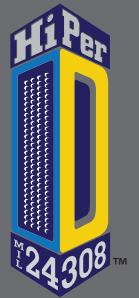

COMBO-D CONTACT ARRANGEMENTS (face view of pin connector)



SERIES 79

Micro-Crimp

The ultraminiature crimp contact rectangular with advanced environmental and EMC performance

- Crimp, PCB, fiber optic, coax, power and pitot
- Precision machined aluminum shells sealed to IP67
- High-density #23 contact arrangements set on .076 centers
- Blind mating for rack and panel applications
- Environmental, hermetic and filter versions
- Integrated ground spring for improved EMI shielding

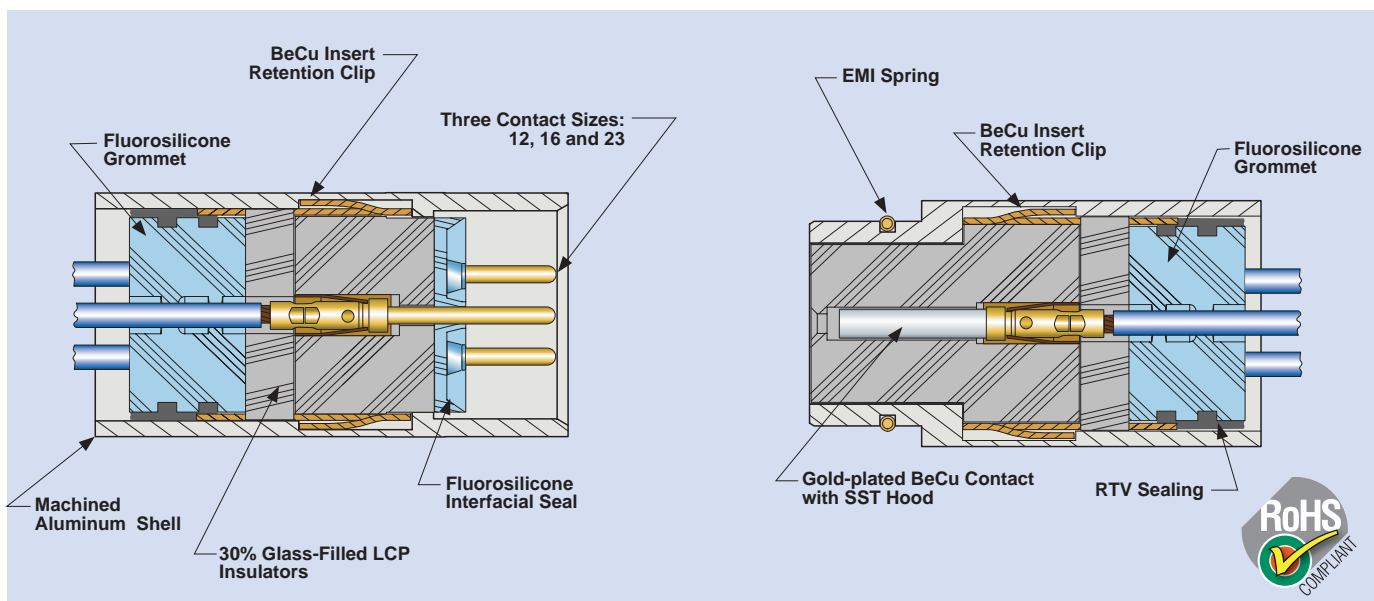

Ultraminature crimp contact rectangular

SERIES 79 MICRO-CRIMP PRODUCT SELECTION GUIDE



Crimp Terminated Cable Connectors



Crimp Terminated Panel Mount Connectors



Panel Mount Connector with Auxiliary Sealing



Right Angle PCB Panel Mount and Free-Standing Connectors



Backshells and Accessories, EMI Adapters and Protective Covers

Blind Mate Guide Pins and Sockets

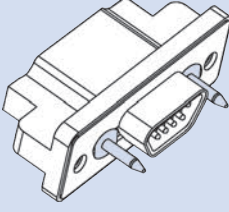

Guide Pins
Connector may be supplied with stainless steel non-removable guide pins.

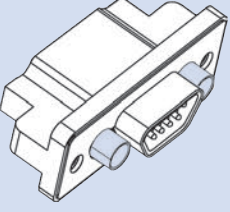

Guide Sockets
Connector may be supplied with stainless steel non-removable bushings.

Selected Contact Types



Standard Signal



Power



Coaxial



Differential Twinax



Fiber Optic



Pitot Tube

Shell Size	Contact Arrangement	Contact Quantity		
		#23	#16	#12
A	A-5	5	—	—
B	B-2P2	—	2	—
	B-9	9	—	—
C	C-13	13	—	—
D	D-15	15	—	—
	D-3P3	—	3	—
	D-7P2	5	2	—
E	E-11P2	9	2	—
	E-19	19	—	—
	E-7P3	4	3	—

Shell Size	Contact Arrangement	Contact Quantity		
		#23	#16	#12
F	F-15P2	13	2	—
	F-23	23	—	—
	F-5P5	—	5	—
G	G-33	33	—	—
H	H-10P4	6	—	4
	H-29P7	22	7	—
	H-36P2	34	—	2
	H-54P2	52	2	—
	H-5P5	—	—	5
	H-66	66	—	—

Shell Size	Contact Arrangement	Contact Quantity		
		#23	#16	#12
J	J-17P4	13	4	—
	J-25P2	23	2	—
	J-33	33	—	—
	J-7P7	—	7	—
K	K-27P4	23	4	—
	K-35P2	33	2	—
	K-43	43	—	—
	K-9P9	—	9	—
L	L-6P6	—	—	6
	L-78	78	—	—
M	M-102	102	—	—

Performance Specifications	
Current rating	Contact size #23 5 Amps, size #16 13 Amps, size #12 23 Amps maximum
Voltage rating (DWV)	Contact size #23 500 VAC rms. size #16 and #12 1800 VAC rms. Sea level.
Insulation resistance	5000 megohms minimum
Operating temperature	-65° C. to +150° C.
Contact resistance	5 milliohms maximum
Water ingress protection	IP67
Shielding effectiveness	>75 dB attenuation from 100 MHz to 1000MHz, >60dB 1GHz to 4GHz, >40dB 4GHz to 10GHz.



For more information contact Glenair at **818-247-6000** or visit our website at **www.glenair.com**
U.S. CAGE code 06324

SPACE-RATED

Lanyard-Release Quick-Disconnect Connectors

For mission-critical disengagement and release of launch and payload systems

Mil-standard 1760 lanyard-release connectors were originally developed for carriage stores management applications including weapons, pods, and drop tanks. Incorporating a common electrical interface as well as interfacing signals and pin and circuit assignments, lanyard-release connectors of this type are broadly employed for reliable, jam-free mating and disengagement. Space-rated versions of 1760 class cylindrical connectors take advantage of the technology's legacy in harsh-duty aircraft applications to ensure reliable and predictable performance in space. From fail-safe application in space station and space telescope deployment to rack-and-panel research equipment interconnection, these rugged axial-pull lanyard connectors deliver proven performance in accordance with all applicable NASA, ESA, and JAXA standards. Available in a wide range of connector packaging, from MIL-DTL-38999 SuperNine® to AS81703* and special small form-factor designs, these proven-performance interconnection devices may be equipped with standard signal or power contacts as well as shielded high-speed coax, twinax, and quadax.



AS81703 space-grade lanyard release push pull mated pair with special order band and boot platform

- Jam-free, push on/pull off technology
- Reliable fail-safe axial pull lanyard equipped coupling
- Instant disengagement for critical quick-release systems
- Manufactured IAW MIL-STD-1760
- Special umbilical buffers and go-betweens also available
- Blind-mate rack-and-panel versions available
- Qualified for military and space application
- Outgas processing IAW NASA, ESA and JAXA

SPACE-GRADE Lanyard-Release Quick-Disconnect Connectors

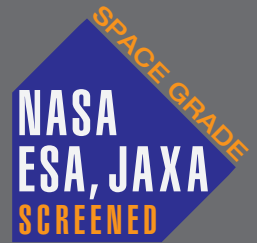

How To Order SuperNine® 233-216 MIL-DTL-38999 Type								
Sample Part Number	233-216	-G6	ME	25-35	S	A	E	-4
Series / Basic Part No.	233-216 = Lanyard Release Plug							
Connector Style	G6 = Plug with EMI Spring							
Finish	ZL = Cres, Electrodeposited Nickel Z1 = Cres, Passivated ME = Al Alloy, Electroless Nickel							
Size and Arrangement	Per MIL-STD-1560 plus high density							
Contact Type	P = Pin S = Socket; 500 cycles							
Alternate Key Position	A, B, C, D, E, N = Normal (Per MIL-DTL-38999 Series III)							
Lanyard Length Code	See Lanyard Length Table							
Connector Type	4 = Type 4 (shown below, no accessory threads) 6 = Type 6 (not shown, includes accessory threads)							

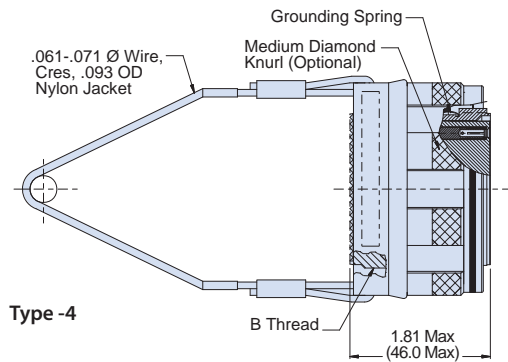

How To Order 253-020 AS81703* Type Push-Pull Lanyard Release							
Sample Part Number	253-020	-08	ME	25-35	S	N	812
Series / Basic Part No.	253-020 = AS81703 Type						
Connector Style	08 = Push-Pull Lanyard-Release Plug						
Finish	ZL = Cres, Electrodeposited Nickel Z1 = Cres, Passivated ME = Al Alloy, Electroless Nickel						
Size and Arrangement	Per AS81703						
Contact Type	P = Pin S = Socket						
Alternate Key Position	N, W, X, Y, B, C						
Lanyard Ring Mod Code	812 = Lanyard ring rotated 90° from master keyway Omit for standard ring						

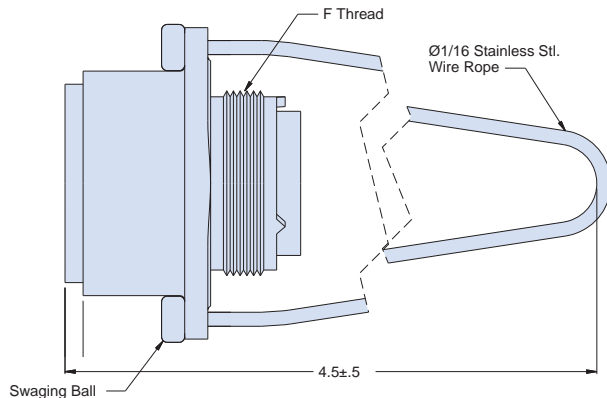

*The MIL-C-81703 standard was superseded by SAE-AS81703 10-December 2010 per Navair



NASA NanoRack CubeSats deployed from the International Space Station. The ISS solar array panels provide the backdrop.

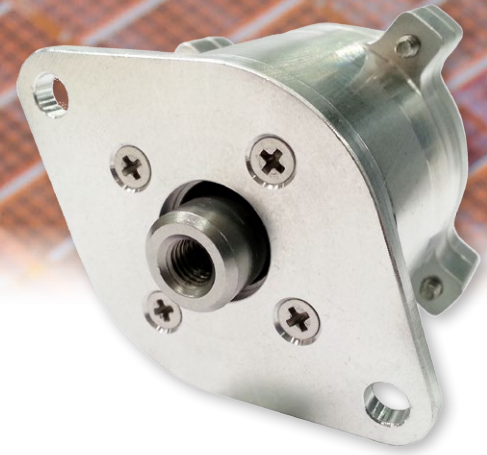
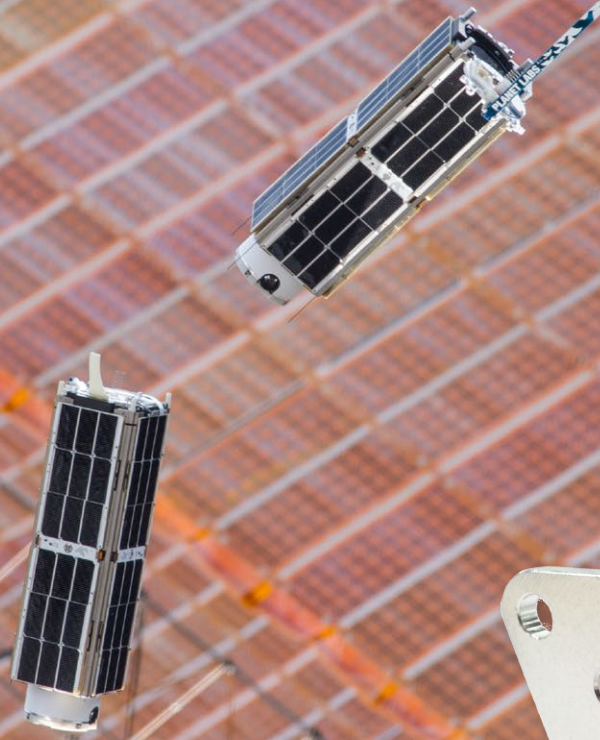

SERIES 06

Hold-Down Release Mechanism Technology

High-reliability, non-explosive electromechanical release mechanism technology for dependable stowage and release of deployable space systems

Glenair HDRM device technology is optimized for reliability with built-in mechanical and electrical redundancy. The planned release of the deployable system is activated by a pre-determined value of electrical current to a fuse-wire system which causes the wire to break under tension and allow the pre-loaded mechanical bolt to actuate. Glenair is now positioned to incorporate HDRM technology into a broad range of customer-defined housing and mounting configurations.

Glenair HDRM devices offer quick release time, low shock, relatively low power input, and almost no temperature sensitivity, in addition to higher preload carrying capacity compared to similar devices.

- **Pyrotechnic-free alternative for single-event release of deployable space systems**
- **Next-generation design and materials**
- **Not susceptible to transient and noise (EMI/EMP/ESD/RFI) inputs**
- **Extended temperature ranges: -120°C to +120°C**
- **User-serviceable/reusable**

Hold-Down Release Mechanism Technology

Resets in minutes

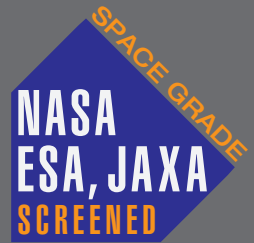

Glenair hold-down release mechanism (HDRM) technology is based on a fusible wire-actuated separation nut design. Increasingly popular for its reliability and non-pyrotechnic action, fusible wire-actuated nut technology has the added benefit of being partially reusable and refurbishable post-deployment. Glenair HDRM technology is immune to all forms of EMI or ESD, and is capable of easily sustaining launch loads as well as defined preloads—with release deployment times comparable to conventional explosive actuators, but with low-shock and low power input.

A broad range of hold down release mechanism technologies have been historically used to hold secure and subsequently deploy satellites and other appendages (solar arrays, antenna reflectors, radiators, instruments, doors, sensors, booms, and so on) in space. Most of these technologies relied on non-reusable (explosive/pyrotechnic) designs that suffered from a broad range of deficiencies, including susceptibility to electromagnetic interference, problematic synchronization of release with mission requirements, high-shock release action, and significantly, the inability to reuse or refurbish the device during test. Historically, actuators and release devices of this type have included:

- Explosive release nuts
- Bolt cutters
- Separation nuts
- Wire and pyro cable cutters

Glenair has taken a different path in the development of a non-explosive HDRM with a consumable initiator which, post-actuation, allows the device to be refurbished and reset on-site, or at the factory. Glenair fusible wire-actuated nut technology solves all of the problems associated with conventional explosive HDRM devices. In addition, the three key components of the Glenair HDRM (preloading assembly, release actuator, and load-carrying structure) may be packaged according to specific customer requirements including the addition of connectors to replace wire leads, cylindrical or rectangular housings, lightweight materials, package size and profile, mounting dimensions and so on. Consult the Glenair HDRM team at our Glendale factory for more information.

SCALABLE DESIGNS FOR CUBESATS

- Fuse-wire based technology
- Electrical initiation up to 5 amps
- Scalable designs: from Nano-Satellite versions to rated 5000 pound units.

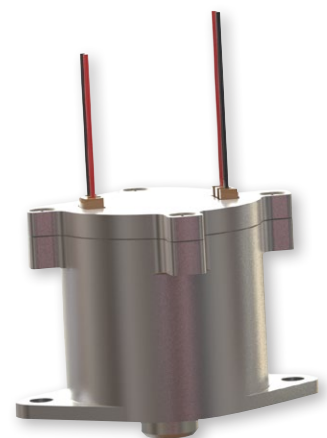

1/4 inch unit with 5,000 pound preload and conventional wire lead interface

Physical characteristics for 1/4 inch unit

Mass	241 grams nominal weight with 18 inch lead wire included
Bolt	1/4-28 UNJF-3B*
Material list	IAW MSFC-STD-3029
Epoxy	Outgassing requirements per GSC19384

Device features for 1/4 inch unit

Redundant initiation	2 initiation points
Field refurbishable	Initiator can be replaced in less than 15 minutes by trained personnel
Reliability prediction	0.9999995
Packaging	External housing typically supplied with two mounting points. Custom housings and mountings available
Connectorization	Standard design supplied with wire inputs. Connectorized versions available
Scalable bolt size	Bolt size determines preload and can be scaled to accommodate a wide range of requirements

*The size callout is based off the bolt size that is to be used. Metric thread can also be called out. Complete test report available upon request

ASSISTED SEPERATION FORCE

High-Performance Circular Blind-Mate Connectors

- Assisted separation force overcomes pin/socket engagement force
- Rack-and-panel versions feature self-aligning floating technology for repeatable mating and de-mating
- Available in most symmetric MIL-STD-1560 insert arrangements with contacts sizes from #23 to #12
- Selected materials offer low outgassing properties and high resistance to both corrosion and stress corrosion cracking
- Optional outgassing bake-out process available (see space-grade guidelines in this section)
- Designed to withstand the rigors of launch and flight—including shock, vibration, thermal vacuum, acceleration, and temperature extremes
- Standard accessory threads and teeth per MIL-DTL-38999 accommodate a wide range of backshell accessories
- Integrated EMI/RFI shield termination band platform versions also available



Application: Glenair Series 253 connectors are designed to meet applicable environmental, electrical and mechanical performance characteristics of D38999 Series III. The technology is well suited for satellite deployment, solar array deployment, interstage release, UAV release, payload and munitions release, as well as for use in commercial blind mate instrumentation panels.

Circular blind-mate connectors

How-to-order • Technical specifications

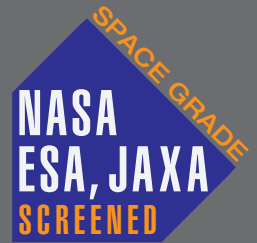

How To Order 253-001 and 253-002						
Sample Part Number	253-001	B	07	ME	21-35	S N
Series / Basic Part No.	253 High Performance Blind Mate, Extraction Force -001 = plug -002 = receptacle					
Rear Accessory Option	- = Accessory thread and teeth B = Integrated band porch and shrink boot adapter S = Single Integrated band porch					
Connector Style*	07 = Jam nut mount					
Material/Finish	ME = Aluminum, electroless nickel MA = Aluminum, electroless nickel - matte finish (space grade) MT = Aluminum, nickel PTFE ZL = CRES, electrodeposited nickel Z1 = CRES, passivated					
Shell Size-Insert Arrangement*	Per MIL-STD-1560 (symmetrical arrangements only)					
Contact Type	P = Pin (253-002 receptacle only) S = Socket (253-001 plug only); 500 cycles					
Alternate Polarization*	A, B, C, D, E, N = Normal (Per L°)					

How To Order 253-005 and 253-006						
Sample Part Number	253-005	-07	ME	21-35	S	N
Series / Basic Part No.	253 High Performance Blind Mate, Extraction Force -005 = plug -006 = receptacle					
Connector Style*	-07 = Jam nut mount					
Material/Finish	ME = Aluminum, electroless nickel MA = Aluminum, electroless nickel, matte finish, space grade MT = Aluminum, nickel PTFE Z1 = CRES, passivated ZL = CRES, electrodeposited nickel Z1S = CRES, Passivated (Space Grade)					
Shell Size - Insert Arrangement*	Per MIL-STD-1560; Symmetrical Layouts Only					
PC Tail Gender/Length	253-005 Socket Contact; 500 Cycles S1 = Socket, PC Tail (.125 - .175) S2 = Socket, PC Tail (.200 - .250) S3 = Socket, PC Tail (.250 - .300) S4 = Socket, PC Tail (.300 - .350)		253-006 Pin Contact; 500 Cycles P1 = Pin, PC Tail (.125 - .175) P2 = Pin, PC Tail (.200 - .250) P3 = Pin, PC Tail (.250 - .300) P4 = Pin, PC Tail (.300 - .350)			
Alternate Polarization*	A, B, C, D, E, N = Normal					

*Refer to Glenair SuperNine® Catalog, Section A for complete details

Refer to Space-grade Guidelines IAW NASA EEE INST-002 outgassing processing/bakeout for modification codes.

Modification codes may be added directly to the end of any valid part number

Current Rating	
Size Contact	Amps
23	5
22D	5
20	7.5
16	13
12	23

MECHANICAL SPECIFICATIONS:

- Operational Temperature Range: -65° C to +200° C
- Random Vibration: 43.92 Grms
- Shock: 300 G
- Durability: 100 Cycles
- Extraction Force: ≤25 lbs linear
- Blue color band: rear-release retention system

Unmated Test Voltages, AC RMS, 60 Hz				
Altitude (Feet)	Service Rating M	Service Rating N	Service Rating I	Service Rating II
Sea Level	1300	1000	1800	2300
50,000	550	400	600	800
70,000	350	260	400	500
100,000	200	260	200	200

Group Focus versus Individual Focus

It's a very sobering feeling to be up in space and realize that one's safety factor was determined by the lowest bidder on a government contract.

I love this quote from Alan Shepard—even though those of us actually in the business of supplying technology for space know that being the lowest bidder is hardly what wins you the business. Rather, it is delivering a product so full of value and so exactly tailored to solving the customer's problem that you win in spite of your price tag. Glenair has been in exactly this business mode since we designed and built Commander Ed White's "Golden Umbilical" for the first US spacewalk in 1965. From backshells on the International Space Station to connectors and cables on the JPL Mars Curiosity Explorer, Glenair has been a go-to partner to NASA, ESA and the broad range of commercial OEM's engaged in the aerospace field.

In the January 2014 issue of *QwikConnect* I paid tribute to the marketing side of our business and thanked that team for their dedication and commitment to their work. Operations, the folks who equip and run our five factories in Glendale, Anaheim, Chicago, Mansfield and Bologna, are no less devoted to their endeavors. And when it comes to the quality and "safety factor" that occupied Admiral Shepard's thoughts as he walked upon the moon, it is our operations team that ensures our interconnect technology gets made right and performs as intended on every mission.

Which brings me to the real topic of this article, *group focus versus individual focus*. It has been my experience that most successful organizations—especially in their formative years—are able to stay focused on larger, shared goals while subordinating individual and department-level goals. But that over time, especially as they "grow and mature," organizational focus tends to shift away from larger, shared goals to an unfortunate prioritization of individual or departmental achievement. We fight this tooth and nail at Glenair. For example, we structure our incentive program so that rewards are tied to the performance of the entire organization. Likewise we specifically enjoin division managers from forecasting production or sales goals for their particular unit. Rather, we revel at our total monthly booking and shipment numbers and enjoy the benefits of each good month as a team.

No one is better at following this wisdom than our operations team. Whether we are building Micro-D's in Mansfield for an ESA satellite application, SuperNines in Glendale for a commercial launch vehicle, or Super-ITS connectors in Bologna for a ground support application, our operations team knows it is "group" focus and not "individual" focus that's going to get the job built and shipped on time. So bravo to all of you committed to following this key principle as we continue to deliver interconnect solutions that give our space explorers and customers peace of mind as they "walk upon the moon."

Chris Toomey

Publisher

Christopher J. Toomey

Executive Editor

Carl Foote

Managing Editor

Marcus Kaufman

Editor/Art Director

Mike Borgsdorf

Graphic Designer

George Ramirez

Technical Consultant

Jim Donaldson

Issue Contributors

Tony Agajanian

Greg Cameron

Garrett Croft

Stellan Olsson

Ben Porcaro

Ross Thomson

Fred VanWyk

Distribution

Terry White

QwikConnect is published quarterly by Glenair, Inc. and printed in the U.S.A. All rights reserved. © Copyright 2015 Glenair, Inc. A complete archive of past issues of QwikConnect is available on the Internet at www.glenair.com/qwikconnect

GLENAIR, INC.

1211 AIR WAY
 GLENDALE, CA 91201-2497
 TEL: 818-247-6000
 FAX: 818-500-9912
 E-MAIL: sales@glenair.com
www.glenair.com

