

QwikConnect

GLENAIR • JULY 2021 • VOLUME 25 • NUMBER 3

LIGHTWEIGHT + RUGGED
AVIATION-GRADE

Air Taxi *Interconnect*
SOLUTIONS



Transitioning to renewable, green-energy fuel sources is an active, ongoing goal in virtually every industry. While the generation of low-carbon-footprint energy—from nuclear, natural gas, wind, and solar—might someday be adequate to meet our real-time energy requirements, the storage of such energy for future use is still a major hurdle limiting the wholesale shift to renewable power.

be harvested from 1 kilogram of an energy source. For kerosene—the fuel of choice for rockets and aircraft—the energy density is 43 MJ/Kg (Mega Joules per kilogram). The “energy density” of the lithium ion battery in the Tesla, on the other hand, is about 1 MJ/kg—or over 40 times heavier than jet fuel for the same output of work. And yet the battery on the Model 3, for all its weight and low “energy

LIGHTWEIGHT + RUGGED AVIATION-GRADE **Air Taxi** *Interconnect* SOLUTIONS

In aviation—an industry that universally relies on kerosene as its primary energy source—this dilemma is profound due to the basic thermodynamics of combustible fossil fuels versus battery-stored electrical power. Take, for example, the thermodynamics of the Tesla Model S all-electric battery-powered car versus the SpaceX Falcon 9 rocket. The high-performance 85 kWh Model S battery pack weighs in at 1,200 lbs. and delivers a range in excess of 300 miles for the 5,000 lb. vehicle. The Falcon9, on the other hand, burns 147 tons of rocket fuel to lift and vector its 50,000 lb. payload into low earth orbit. Apples and oranges, you say, as the scale of the missions and the “concepts of operation” are so different. True, but that in fact is the point.

Different types of fuel can be measured for efficiency using a simple rule called “energy density.” Energy density is the measure of the energy that can

density” is perfectly suited to meet that vehicle’s “concept of operation” i.e. short to medium length trips, at high speed, with a robust payload. The difference of course is the Model S is not flying but driving to its destination.

A plane flies when the “lift” it generates equals the all-in weight of the aircraft. Lift of course can be achieved in various ways, including aerodynamically shaped wings, copter rotors, jet propulsion and so on. However it is achieved, the heavier the aircraft, the more lift is required to get it off the ground and accelerate it on its way. So, whenever we increase the weight of an aircraft (unlike a car) with a lower-density power source (such as a battery) we must increase the plane’s mechanism of lift accordingly.

By way of reference, about 20% of the all-in weight of a commercial aircraft is its fuel. Given their relative energy densities, the transition to battery power from kerosene in an Airbus A320 would result in an additional 260,000 Kg of weight—or more than four times the total weight of the aircraft itself. The Falcon9—to return to our ridiculous comparison—

◀ ENERGY DENSITY COMPARISON

SpaceX Falcon 9: 43 MJ/Kg

Tesla Model S: 1 MJ/kg



photo: NASA



photo: raneko via Wikimedia Commons

would need in excess of 6000 Tons of battery power to replace its 147 Tons of rocket fuel. And one can only imagine the kind of lift design that would be required to get that baby off the ground.

And therein lies the challenge for the nascent air taxi or Urban Air Mobility (UAM) industry. In fact, the only realistic circumstance in which eVTOL air taxis (electric vertical takeoff and landing)—flying in and out of urban air terminals—would be able to function solely with battery-powered propulsion is in small, ultralight aircraft with limited carrying capacity, limited flight duration, and limited range.

Nevertheless, industry experts agree a market exists in high-density urban settings made up of individuals who will pay for fast air trips to popular destinations, rather than slog it out on congested city streets. This has every major aircraft manufacturer—as well as countless other entrepreneurs—actively engaged in eVTOL air taxi R and D. Incumbent OEMs including Boeing, Airbus, Embraer, and Bell all have active programs. And the many aerospace system manufacturers including Raytheon, GE, SAFRAN, Rolls-Royce, Honeywell and others are also hard at work developing new classes of electric and hybrid propulsion systems, fly-by-wire controls, electric motor controllers and more. The major automobile manufacturers are also fully engaged including Hyundai, Toyota, GM, and others. And not surprisingly,

much of this work includes all-electric as well as hybrid designs that leverage other sources of power such as small form-factor kerosene engines and hydrogen fuel cells.

Indeed, it may turn out that the most viable air taxi designs are small jet engine configurations augmented with backup battery power, similar in concept to hybrid automobiles but with the fossil-fuel engine acting as the primary power source generating electrical power, or with electrical motors reduced to auxiliary roles, such as emergency backups in the event of engine failure.

▼ THE RISE OF THE AIR TAXI

Vertical Take-Off and Landing aircraft with the ability to transport passengers or cargo short distances in the urban landscape may be either piloted or autonomous, and operate with environmental controls designed to moderate their impact on urban populations.



Artist's conception of an eVTOL design with combined lift-and-cruise functions on articulating wings and horizontal NOTAR tail section, a system that uses a tail boom and fan to build a high volume of low-pressure air, utilizing the Coandă effect.

Air Taxi *Concepts of* OPERATION

The first issue to tackle in a discussion of how air taxis will fit into the urban landscape, their “concept of operation” as the cool kids say, is that, like conventional helicopters, they will need to take off and land vertically. The infrastructure currently envisioned for such services is likely to take the form of rooftop air terminals, or skyports, with on-demand passenger flights departing to a range of fixed destinations such as airports, resorts, convention centers, adjacent city centers, and so on. In addition, and in order to reduce the environmental impact of the service, described operations are promised to be clean, green, quiet and safe.

Up in the sky, the aircraft are shaping up into five categories or types, each designed to meet the most common mission-profiles, from short duration flights to longer, inter-city jumps, and deliver zero local emission performance. To help provide a little more detail and understanding of these five types, we’ll take a look at some real-world examples, starting with perhaps the most power-intensive design, the Vectored Thrust.

Vectored Thrust (DEVT)

Vertical takeoff and landing aircraft that use the same propulsion system for hover and cruise operations are generally referred to as “vectored thrust” aircraft. Like the well-known Harrier jet design, they use the same propulsion system for Liftoff, landing and forward propulsion. Lilium, a German-based enterprise and design, is a prime example of a unique form of Vectored Thrust, called a “Ducted Electric Vectored Thrust (DEVT)” aircraft. In this implementation, two banks of propellers and electric jet engines—housed in rotatable flaps in the wings—are mechanically oriented for both hover and cruise functions. Additional vectored propulsion—for a total of 36 individual jet powered electric motors and propeller systems—is housed in a forward Canard. The eponymous Lilium flagship leverages its unique DEVT system to optimize aircraft versatility for both short duration flights and longer distance city-to-city jumps. And as designed, the Lilium is configured as a 6 passenger plus pilot aircraft, making it one of the larger form-factor eVTOLs in development. QwikConnect is not rooting for winners, but we have to observe that the design aesthetics of the Lilium flight control surfaces make it one of the most compelling jet designs in the long history of aviation. And the promised efficiency of the aircraft at cruising altitude and speed make it one of the most versatile in terms of mission-profiles.



The Lilium jet shown with wings rotated in cruise orientation (above) and on the tarmac with wings in their vertical orientation (below) ready to lift and hover once passengers are boarded.

Images courtesy Lilium



Transitioning Multicopter

Powered with six tilting propellers for both lift and cruise functions, the five-seater plus pilot Joby S4—our featured example for a Transitioning Multicopter eVTOL—is designed for urban air transport with a range of up 150 miles. The aircraft is a mature design with over 1000 logged test flights, a production manufacturing arrangement in place with Toyota, and significant investment backing from Reinvent Technology Partners. On the operations side, Joby has acquired Uber Elevate to create a seamless urban transport system from rideshare car, to air taxi, and back again. In addition, a partnership with parking garage operator REEF will form the foundation for a network of sky ports.

In terms of design, the outboard propellers on the S4 tilt with the nacelle while the inboard propellers actuate with a unique linkage mechanism. This design allows the flight control wings to remain fixed during all modes of flight. The V-Tail is also equipped with a pair of tilting nacelle rotors. For propulsion, each Joby S4 propeller is equipped with two 70 KV motors for complete redundancy.

A low-noise signature is a hallmark of the Joby S4. The six amply-sized rotors on the aircraft are 2.9 meters in diameter, giving the aircraft just 46 Kg/m² of disc loading and contributing to its low-noise performance and long battery life expectations (less power intensive during hover). In addition, all rotors are equipped with an Anhedral Tip which contributes to both hovering and cruise-mode performance as well as noise reduction.

As shown in the photograph below, the four outboard propellers on the Joby S4 tilt with their nacelles, while the two inboard propellers actuate with a linkage mechanism

Image courtesy Joby Aviation

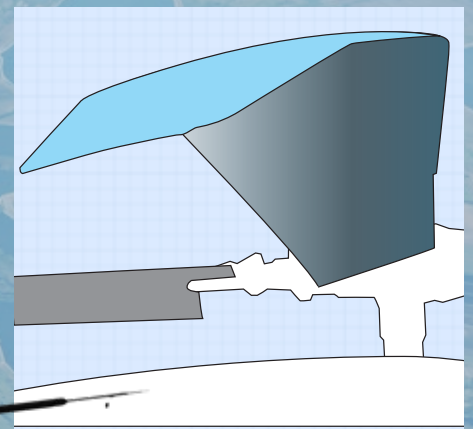

Anhedral Tip rotor design (above). The Joby S4 (left) utilizes an Anhedral Tip for performance and noise reduction.

Aircraft photograph courtesy Joby Aviation

Lift and Cruise

For this category of eVTOL design we have chosen to highlight the six-passenger, piloted Beta Technologies Alia, a Lift and Cruise aircraft with separate, fixed-position propulsion systems for lift (hovering) and cruise (forward thrust).

The Beta Technologies Alia is a versatile aircraft design with dual capabilities for short duration flights as well as longer mission-profiles, and an interesting focus on both passenger and cargo implementations of their flagship aircraft, the Alia 250 and 250c. And worthy of note, Beta Technologies has already inked a deal with UPS Flight Forward, a subsidiary of United Parcel Service for 150 Alia 250c aircraft.

Flight control is managed by the speed and vector control of the propeller system, combined with conventional wing flaps. Beta Technologies, based in Vermont, has invested heavily in a unique, modular base-station and charging facility platform which promises to recharge the aircraft battery in just one hour, for fast turnaround flight scheduling. The range of the Alia is described by the manufacturer as 250 nautical miles, making it suitable for longer-category missions. The design language of the aircraft (its flight surfaces especially) were, according to Beta, inspired by the wing profile of the Arctic Tern, perhaps the most intrepid avian commuter in the world.



The Lift and Cruise Alia (above) will quickly charge at a modular base station (left) for quick-turnaround flight scheduling.

Images courtesy Beta Technologies

Wingless Multirotor

Wingless eVTOL aircraft have multiple rotors which handle all aspects of the aircraft operation, including vertical liftoff and landing, forward cruising, and flight control. Flight control is managed by both vectoring the rotors and by modulating rotor speed and torque. The EHang 116, manufactured in China, is the poster child for this design and stands out as one of the farthest along in actual aircraft production and deployment. Unlike the Lilium and the Beta Technologies Alia, the EHang 116 is optimized for short-distance flights only. The massive energy cost to power its 16 rotors limits the duration of flights to just intra-city destinations in which a significant portion of flight time is consumed by liftoff and landing. EHang aircraft are likewise limited in passenger capacity. The 116 version is optimized for autonomous (pilotless) flight with a single passenger. Readers interested in the EHang success story should check out their partnership with the Dubai RTA that is already implementing a forward-thinking air taxi program based around the EHang 116 and 184 wingless multirotor aircraft.

Top: The EHang 216 AAV on a trial flight in Japan.
Middle: conceptual art of an Eco-sustainable Vertiport
Bottom: EH216 conducting passenger-carrying trial flights at the Digital China summit

Images courtesy EHang



Gyrodyne

A Gyrodyne is a proven category of VTOL aircraft with a long qualification history under FAA Part 29 rotorcraft requirements. In operation, a single top-mount rotor is employed for both takeoff and landing. Forward thrust during flight is provided by conventional propeller or jet engines. As mentioned, Part 29 regulations are well understood, both by aviation engineers and by the regulators themselves, making this an attractive design concept—especially given the high cost of certification efforts for new, innovative designs.

While there are several viable eVTOL Gyrodynes now in development, we have selected Jaunt Air Mobility's "Journey" for our featured example in this category. The Jaunt Journey features a single, large main rotor and four forward-positioned rotors. The battery powered electric main rotor should be both efficient and quiet during take off and landing given its relatively slow spin rate and large form factor.

The helicopter-like aircraft is not equipped with a tail rotor to offset the main rotor's torque. Rather, the four large electric props mounted on the wing prevent the aircraft from tailspinning during hover-mode, and as mentioned, provide the necessary forward thrust to accelerate the aircraft to its cruising speed of 175 MPH.

Interestingly, the large central rotor offers a significant safety premium compared to multirotor systems. This is due to the patented Jaunt Air Mobility technology called SRC (Slowed Rotor Compound) which modulates the main rotor in accordance with aircraft speed, and provides the ability for the aircraft to autorotate down in the event of power system failure.

Jaunt Air Mobility is privately held and self-funded. The Dallas, Texas based company has plans to achieve FAA certification by 2023 and commence commercial services by 2025.

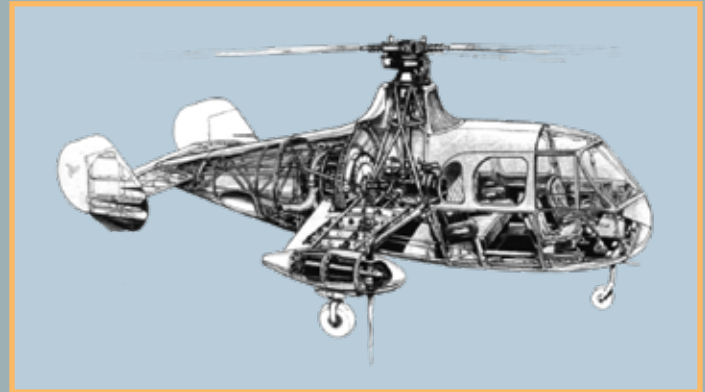

Schematic drawing of a prototype Fairey Gyrodyne rotorcraft from 1946



The Jaunt Air Mobility Journey

Image courtesy Jaunt Air Mobility

DISTRIBUTED Electric PROPULSION

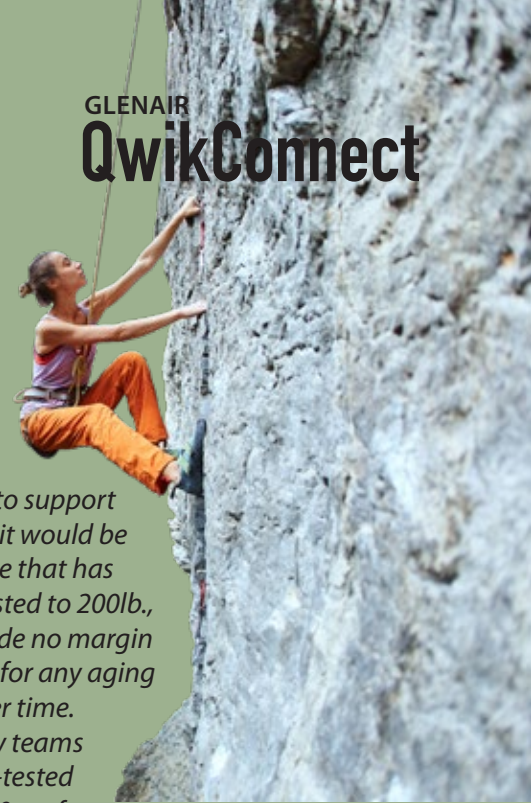

NOTE: This is an excerpt from a technical Glenair whitepaper on the topic of all-electric distributed power in eVTOL systems. For the complete dissertation, including, charts, tables, footnotes, etc., please consult the whitepaper available at glenair.com/eVTOL-air-taxi-interconnect-solutions.

Distributed Electric Propulsion (DEP) is a key element of all eVTOL aircraft. A basic description of a DEP design is a power transmission system whose electrical energy sources are interconnected, via EWIS cabling, to multiple electric-motor-driven propellers or rotors. The native power sources in a DEP can be as simple as a battery-plus-inverter design, or as complex as a hybrid system made up of gas combustion engines, storage cells, electric generators, inverters, power feeder cables, interconnect harnessing, and more. The DEP is designed to feed aircraft “propulsors,” or thrust producing devices including propellers and fans, with adequate power for vertical takeoff, landing, and cruise operations.

An all-electric DEP system may incorporate high-voltage elements (greater than 3kV) as well as high kW power for peak output to electric propulsion motors, inverters, controllers, and batteries during takeoff and landing. Shared components may be grouped together or distributed throughout the airframe for a redundant distributed thrust system.

The safety hazards inherent in such distributed electric systems requires the platform be designed and configured with robust technologies qualified for high-voltage, high-current, and high-frequency aviation applications. The following guidelines explore these critical issues in greater detail.

Working Voltage vs Dielectric Withstanding Voltage

All DEP designs begin with a definition of the operational voltage, or maximum continuous working voltage, of the equipment. For all DEP applications, a certain safety factor is required between equipment operational voltage (OpV) and the proof-test voltage (DWV) of interconnects and other EWIS components. However, the magnitude of this safety factor varies greatly depending on the exact implementation of the distributed power system.

Here is a useful metaphor for why aviation systems take “derating” so seriously: if a lifeline rope needs to support a 200lb individual, it would be unsafe to use a rope that has only been proof-tested to 200lb., as this would provide no margin for error, nor allow for any aging or degradation over time. Instead, emergency teams use a 2000lb proof-tested rope, providing a 10x safety factor to guarantee performance in critical situations. However, if the goal is to hang a 20lb bicycle in a garage—where failure could hardly lead to loss of life—a 50lb proof-tested rope (2.5x) would likely be sufficient. For this reason, high safety derating factors are always used in aviation interconnect systems where failure could result in loss of life. FAA or other national agency qualification of eVTOL electric propulsion systems will absolutely require adherence to higher levels of safety and testing in electrical wire interconnect systems.

This table illustrates the relationship between the actual Working Voltage of an aviation-grade system to the tested Dielectric Withstanding Voltage of its component parts:

Suggested DWV Based on Referenced Industry Standard	
Working Voltage (OpV)	Suggested Dielectric Withstanding Voltage (DWV)
250	1,500
500	2,000
750	2,500
1,000	3,000
1,250	3,500
1,500	4,000
1,750	4,500
2,000	5,000

By way of example, while it is common practice for airframe harnesses to operate at 115 VAC, these cables would need to perform and be tested at 1500 VAC DWV for flight qualification.

DISTRIBUTED **ELECTRIC** PROPULSION [CONTINUED]

Partial Discharge

Partial discharge (PD) in electrical wire interconnect systems refers to a localized breakdown of insulation materials, which does not result in catastrophic failure degrading the insulation between conductors. Simply put, PD is small yet measurable micro-failures that leave the insulation intact, but over time may age and reduce the life of the interconnect system. Partial discharge is a critical issue in advanced eVTOL airborne power applications, given the role of the cabling in distributed electrical propulsion applications, and the higher voltages, current levels, and frequencies typically carried by such transmission lines.

Here's a useful metaphor to illustrate this point, once again using a rope: for a fibrous load-bearing rope, when the load is near breaking strength, individual fibers may fail. Initially, loss of one or two fibers would be negligible, and the rope would continue to support the load. However, over time, as more fibers fail, the accumulative effect would eventually compromise the overall integrity of the rope, and total failure would occur. Similarly, individual partial discharges do not cause immediate failure, but will erode the insulation and eventually lead to failure—a condition that is absolutely intolerable for any airborne system.

In terms of FAA and other agency qualification of eVTOL aircraft with distributed electrical power, there are several types of partial discharge to consider:

- **Void Discharge** – partial discharges that occur in air voids within an insulation system. The voids can be created either by defect (an air bubble in a molded insulator for example) or by design (clearance zone between contact and insulator cavity). Internal discharges ionize the air, creating byproducts such as ozone, and release UV energy, which causes chemical breakdown of the insulator.
- **Surface Discharge** – partial discharges on the surface of an insulator. Naturally occurring contaminants deposited on the surface of an insulator create a conductive path. Upon conduction, the insulator carbonizes (or “burns”), creating a permanently conductive path.
- **Corona Discharge** – partial discharges which occur in air when the electric field created by a high-voltage conductor is higher than the strength of the air. Similar to void discharges, corona discharge creates byproducts, such as ozone, and in turn releases UV energy, which cause chemical breakdown of nearby insulators.
- **Treeing** – a secondary effect of internal discharges created by void discharge, conductive impurities, or defects, which lead to insulation damage. This is similar to surface discharges, but internal to the insulator. As treeing progresses, a branched network of conductive paths is permanently created within the insulation.

Partial discharge testing is an essential performance requirement for airborne applications that, again, handle high voltage and/or high current electrical energy.

Frequency Effects

Airborne power distribution systems use a wide range of frequencies for various applications. Battery banks provide DC power. In more-electric aircraft (MEA), generators produce power at 400 Hz AC. In all-electric aircraft (AEA), variable-frequency drives (VFD) powering electric motors



XLPE Breakdown Voltage at Various Source Frequencies		
Source Frequency	Breakdown Strength (kV _{RMS} /mm)	Relative Change (vs 50 Hz)
DC	438.4	↑ 406.06%
50 Hz	86.63	-
300 Hz	74.95	↓ 13.49%
500 Hz	73.02	↓ 15.71%
1000 Hz	64.48	↓ 25.57%
1500 Hz	57.36	↓ 33.79%
2000 Hz	56.87	↓ 34.35%
2500 Hz	51.96	↓ 40.02%

produce fundamental frequencies from 1 kHz to 4 kHz, using pulse-width modulated (PWM) switching frequencies up to 30 kHz .

Due to several physical phenomena, including dielectric heating and ion accumulation, source frequency affects the dielectric strength of the insulation. Simply put, high frequency loads put additional stress on the insulation, leading to lower breakdown voltages. While most materials degrade with increased frequency, the sensitivity and degree of degradation vary between materials. Let's take a look at the impact of higher frequencies on XLPE (a common insulating material in high-voltage cables)

Most airborne interconnect test regimens do not include electrical tests using frequencies other than 60 Hz. For example, interconnect manufacturers perform DWV at 60 Hz in accordance with EIA-364-20. In the case of distributed electric propulsion systems, however, Glenair considers it far more

prudent to broaden the range of high-frequency testing to ensure our native airborne



Source: "The Effect of Frequency on The Dielectric Breakdown of Insulation Materials in HV Cable Systems."⁸

Jiayang Wu, Huifei Jin, Armando Rodrigo Mor, Johan Smit; Delft University of Technology; 2017

interconnects, such as PowerLoad, are well-suited to support higher frequency generators, variable frequency drives, and other such equipment.

In fact, for AEA applications operating at substantially higher frequencies, ignoring frequency derating could have dire consequences on performance and reliability. Similarly, using DC-rated products in AC applications is inadvisable given the need to optimize passenger safety.

Operational Stress Factors

In application, there are numerous operational factors that may affect long-term reliability of the electrical wire interconnect system including:

- **Increased temperature** = decreased insulation effectiveness resulting in thermal aging and reduced dielectric strength.
- **Increased humidity** = Increased leakage current, surface conductivity, and reduced dielectric and creepage (tracking) strength.
- **Increased mechanical stress** = contact fretting, material embrittlement, and reduced dielectric strength.
- **Chemical exposure** = surface corrosion, material breakdown, insulation aging, and reduced dielectric strength.
- **Increased voltage** = increased insulation failure, electrochemical erosion and intrinsic breakdown.
- **Increased source frequency** = increased dielectric heating, leakage current, and reduced dielectric strength.
- **Increased partial discharge** = increased carbonization/resistance, chemical degradation, and eroded insulation integrity

While it is certainly possible that wire interconnect technologies qualified for use in automotive or

DISTRIBUTED **ELECTRIC** PROPULSION [CONTINUED]

general industrial applications may be successfully employed in eVTOL air taxi applications, Glenair's expectation is that the FAA and other qualifying agencies will take a dim view of interconnect technology that has not been tested and approved for its proven resistance to common airborne operational stress factors.

Current Rating

When electrical current travels across a conductor, inefficiencies and resistance in the conductor cause some of the electrical power to convert into heat. This can be seen in the glowing filament of an incandescent light bulb or the red-hot coils in a toaster oven. The total heat produced is dependent on the current moving across the conductor (measured in amps, "A") and the inefficiency of the conductor, or resistance (measured in Ohms, Ω).

For any given conductor, as more current is applied, more energy is converted into heat. The heat generated causes the conductor to reach temperatures above ambient, a process known as "temperature rise."

For any given current, less efficient (or more resistive) conductors will lose more energy to heat, and experience greater temperature rise. Large conductors (measured in "gauge," typically American Wire Gauge or "AWG" in North America) have more material to conduct the current, and therefore lower resistances. Similarly, different conductor materials have inherently lower resistances (copper versus aluminum, for example).

The lower the resistance, the lower the temperature rise. By extension, the lower the resistance, the greater the allowable current for a specified allowable temperature rise. This is the foundation for current rating.

For any given conductor and current, the temperature rise is a balance between heat produced and heat lost through conduction or convection. For eVTOL airborne applications, low-density, high-altitude air is a very poor coolant, keeping more heat in the conductor and leading to higher temperature rise. As a result, current ratings for eVTOL interconnect products are generally lower



than current ratings for land and sea interconnect products, even if the underlying interconnect is essentially identical.

Here's another handy metaphor: it is common knowledge that water feels colder than air. 60°F air would feel like a nice fall afternoon. However, 60°F water would lead to hypothermia within an hour. Compared to air, water has a high heat-capacity and conductivity. Water can pull heat from the human body faster than it is metabolically produced. Similarly, water effectively pulls heat from conductors, allowing higher currents to be obtained while maintaining a low temperature rise.

In eVTOL airborne power distribution systems, there are practical limitations to the maximum temperature rise. Most electrical interconnects are only rated to 200°C, some a bit higher (230-260°C), some a bit lower (150-175°C). Often the electrical equipment utilizing the interconnect could have an even lower temperature rating. Also, ambient temperature will vary between applications, depending on location within the aircraft and proximity to other equipment. The difference between the maximum permissible temperature of the interconnect and the ambient temperature is the *maximum allowable temperature rise*. Application conditions dictate maximum allowable temperature rise, and by extension the maximum current permissible on any given conductor.

Current Derating

With baseline current rating established by allowable temperature rise under ideal conditions, conductor performance can then be derated to conform with estimated performance under actual application.

As just discussed, **the first current derating element is allowable temperature rise**, determined by the difference between ambient temperature and maximum allowable temperature of the interconnect. Since temperature rise under

load will vary based on gauge, conductor material, and insulation, it is best to evaluate the temperature rise data for each unique assembly. However, SAE AS50881 does provides a conservative estimate which may be used as a universal reference point.

The second primary current derating factor is the number of wires in a harness bundle. A single wire can freely dissipate heat through convection since all outer surfaces are exposed to ambient air. However, as additional wires are added to a bundle, wire surfaces are in contact with each other and therefore lose the ability to dissipate heat. This is especially true for wires at the center of a large bundle. Since the wires are no longer able to dissipate heat efficiently, current must be limited to reduce the aggregate heat produced. The offset of heat produced versus heat dissipated will ensure temperature rise does not exceed the maximum allowable. While “bundle derating” is ideally evaluated for the unique assembly, again AS50881 provides a conservative estimate which may be used as a universal reference point.

The third primary current derating factor is altitude. At sea-level (standard pressure), air is dense and able to convect substantial heat away from the wire. However, at higher altitudes (low pressure), air density is reduced. Reduced air density means there are fewer air molecules available (per unit volume) to convect heat away from the wire. Since the air is no longer able to convect heat as efficiently, the current must be limited to reduce the heat produced. The offset of heat produced versus heat dissipated will ensure temperature rise does not exceed the maximum allowable. While “altitude derating” is ideally evaluated for the unique assembly, again AS50881 provides a conservative estimate to be used as a universal reference point.

The fourth current derating factor is source frequency. In an AC system, the current alternates direction along the conductor. When current travels one direction, a magnetic field is generated which supports the current flow through inductance. As current reverses, the magnetic field collapses, and the inductance opposes the current reversal. This is known as counter-electromotive force (CEMF), or “back EMF.”

The CEMF is strongest at the core of the conductor, leaving the outer surface less effected and more

available to conduct the source current. The “skin effect” is where AC current tends to only conduct on the outer surface of the conductor, leaving the core useless. At higher frequencies, the period of reversal is reduced, and CEMF has

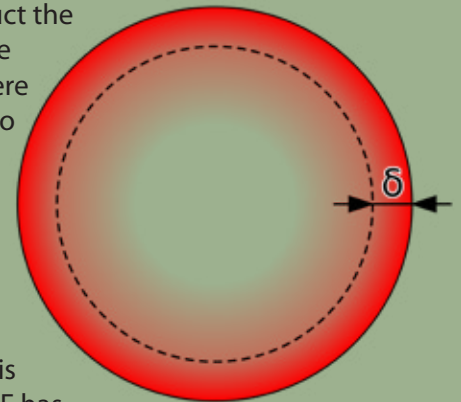

less time to dissipate. As a result, higher frequencies lead to more core left unutilized, pushing more current to the outer surface. We can calculate the “skin thickness” (δ) to estimate how much of the conductor is in fact utilized. If the skin thickness is greater than the conductor radius, then we would expect the conductor to be fully utilized. However, if the skin thickness is less than the conductor radius, we would expect core loss.

As shown in the table below, standard power frequency (60 Hz) will utilize 100% of all conductors up to 4/0. However, 400 Hz MEA power will only utilize 100% of conductors up to 2AWG, suffering loss on larger conductors. For AEA applications with high frequency and shallow skin depth, the alternating current will utilize only a small portion of large conductors. With the current only traveling across a small percentage of the conductor, conductor efficiency is lost, and conductor performance may be estimated using an elevated current at lower frequency.

Glenair engineering routinely analyzes any application where the conductor may experience skin effect loss to more exactly estimate current rating and temperature rise.

Conductor Percent Utilization due to Skin Effect at High Frequency							
Conductor		Source Frequency (Skin Thickness, inch)					
AWG	Radius	60 Hz (0.372)	400 Hz (0.131)	1000 Hz (0.083)	1500 Hz (0.068)	2000 Hz (0.059)	2500 Hz (0.053)
8	0.064	100%	100%	100%	100%	99%	97%
4	0.102	100%	100%	97%	89%	82%	76%
2	0.129	100%	100%	87%	78%	70%	65%
1/0	0.162	100%	96%	76%	66%	59%	54%
2/0	0.182	100%	92%	70%	61%	54%	49%
4/0	0.230	100%	82%	59%	50%	45%	41%

Calculated estimates for copper ($\rho = 1.72 \times 10^{-8} \Omega\text{-m}$, $\alpha = 4.29 \times 10^{-3} \text{ } ^\circ\text{C}^{-1}$) at 25°C

DISTRIBUTED **Electric** PROPULSION

FREQUENTLY-ASKED QUESTIONS

What is the difference between “breakdown voltage,” “DWV,” and “voltage rating?”

- Breakdown voltage is the voltage required to cause failure and permanent damage to electrical equipment.
- Dielectric withstanding voltage, or DWV, is a proof-test voltage performed to ensure the electrical equipment is free from defects.
- Voltage rating, AKA working voltage, is the operating voltage of the equipment.
- To provide safety margin, there is always a difference between operating voltage and DWV test voltages. In practice, Glenair provides DWV test data for our interconnect technologies to ensure defect-free material makeup, but it is understood to be the customer’s ultimate responsibility to derate DWV according to their exact requirements. For situations in which an actual qualified voltage rating is essential—again as opposed to a DWV test voltage—additional testing and evaluation may be completed by Glenair.

What does “current rating” mean?

- Current rating is the maximum allowed current before failure, often defined as 42.8°C temperature rise for a single conductor at sea-level. It is acceptable to use a conductor for currents greater

than the current rating if the system can tolerate the corresponding temperature rise. However, increased altitude and wire bundle size will reduce performance, and should be derated accordingly. Any application requiring currents in excess of the standard current rating should be carefully evaluated on an application-by-application basis. Glenair engineering may assist evaluation in accordance with SAE AS50881.

What is partial discharge, and how does it affect performance?

- Partial discharge is localized breakdown within the insulation which does not fully bridge between conductors. Small defects within the insulation, such as air voids or contaminants, are the primary cause. While partial discharge does not result in immediate failure, it will accelerate insulation aging and shorten the interconnect life expectancy. Partial discharge takes many forms, including void discharge, surface discharge, corona discharge, and treeing.

How does altitude affect voltage performance?

- In general, clearances between components in connector insulation are filled with air. The air pockets are electrically insulating, acting as virtual “components” within the insulation system. Increased altitude reduces air pressure, which reduces the electrical (dielectric) strength. As the air’s dielectric strength is reduced, the total combined strength of the insulation system is reduced as well.

How does source frequency affect voltage performance?

- Increasing the frequency of the applied power source increases stress on the insulation, reducing the breakdown voltage (and therefore DWV and voltage rating) of the interconnect. Direct current (DC) sources are the least stressful on insulation, allowing much higher voltages than alternating current (AC). The interconnect testing standard is power-frequency AC (50/60 Hz). Increasing frequency will reduce strength and the interconnect should be derated accordingly. Any application requiring high frequencies (>800 Hz) or optimized DC performance when only AC DWV is known should be carefully analyzed for safe performance.

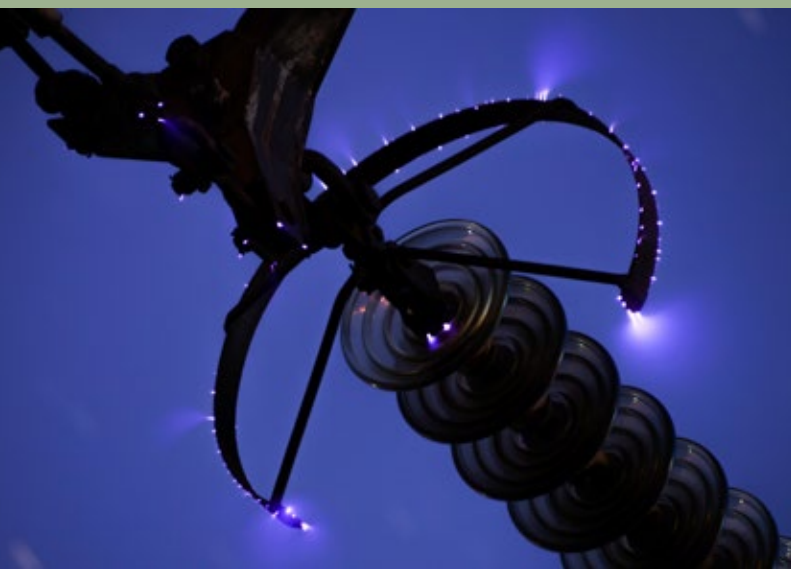

▲ Corona Discharge on a 500 kV power line

Photograph by Nitromethane via Wikipedia



▲ DWV testing of a Glenair high-voltage interconnect assembly at our independently-certified test laboratory

How does source frequency affect current performance?

- Increasing frequency reduces current rating. Two critical factors, skin and proximity effect, combined with high frequencies, prevent full utilization of the conductor. High frequencies are particularly detrimental to the performance of larger conductors. Again, for applications in frequency ranges greater than 800 Hz, additional analysis must be performed to ensure safe and reliable performance.

How do we estimate reliability?

- Various methods may be employed to estimate interconnect long-term reliability by applying elevated stress-factors to induce failure, then deriving life-expectancy at intended usage through complex calculations. Accelerating factors include elevated voltage, elevated temperature, temperature cycling, and increased frequency. Accelerated aging tests may be useful in some instances, but the gold standard of reliability testing is Weibull analysis. For mission-critical systems utilizing high-voltage, high-current, and/or high-frequency interconnects, it is Glenair's preference to determine reliability through this methodology to ensure safe and reliable performance of the electrical wire interconnect system.

What are the key terms and definitions of Distributed Electrical Propulsion?

AC	Alternating Current, supply current cyclically changes direction
Breakdown	Catastrophic failure in electrical insulation resulting in instantaneous and complete loss in electrical performance
Current	Rate of flow of electrical charge, usually measured in amperes (A)
DC	Direct Current, supply current flows in one continuous direction
DWV	Dielectric Withstand Voltage, proof-test voltage to ensure interconnect is free of manufacturing defect
Frequency	Cyclical rate of change in current direction for AC systems, usually measured in Hz (cycles per second)
OpV	Operational Voltage, safe working voltage for continuous use based on application environment and reliability requirements
PD	Partial Discharge, localized failure in electrical insulation resulting in slow aging of electrical insulation, usually measured in picocoulombs (pC)
Safety Factor	Difference between OpV and DWV, required to ensure proper operation and varies based on application criticality
Skin Effect	Loss in conductor utilization and efficiency due to counter-electromotive force (CEMF) in high-frequency alternating currents
Voltage	Electrical potential difference between two conductors, usually measured in volts (V)

A BRIEF HISTORY ~ o f t h e ~ Flying Car

The dream and promise of the flying car is more than a century old. This brief history of some of the more audacious attempts demonstrates how long and arduous the journey has been.



1917

Renowned aviator Glenn Curtiss, rival of the Wright Brothers and a founder of the U.S. aircraft industry, could also be called the father of the flying car. In 1917, he unveiled the Curtiss Autoplane at New York's Pan-American Aeronautic Exposition. It featured an aluminum Model T Ford-like body, four wheels, a 40-foot wingspan, and a giant 4-blade propeller mounted in the back, which unfortunately was unable to generate adequate lift to propel the aircraft beyond just a few hops down the runway.



1947

Henry Dreyfuss combined a lightweight fiberglass automobile body with a wing-and-propeller module to create the ConvAirCar. Unfortunately, it crashed during a test flight, killing its operator, and ending enterprise.

1935

Frank Skroback, a retired industrial technician and electrician from Syracuse, studied the concepts of French furniture-maker-turned-aircraft designer Henri Mignet, and modified his tandem wing monoplane design into a multi-purpose, 6-wing, 21 foot long Flying Car.



1953

Leland Bryan of Buick flew his Autoplane, which used a rear propeller for forward propulsion. Bryan died in 1974 when he crashed an Autoplane at an air show.

1973

Aerospace engineer Henry Smolinski unveiled the AVE Mizar "Flying Pinto," in which the back half of a Cessna Skymaster was mated with a stripped-down Ford Pinto body. The car engine was used for surface travel and runway boost on takeoff. In flight, the craft depended on Skymaster wings, a twin-boom tail and pusher propeller. All flight equipment was detachable to convert the vehicle for street travel. Sadly, Smolinski and pilot Harold Blake died when a wing folded in a test-flight crash.



1989

Aeronautics engineer and inventor Paul Moller worked to bring a flying vehicle to the mass market for four decades. In 1989 he launched the M200X prototype, now known as the Moller M200G Volantor, a multi-rotor vertical take-off and landing aircraft. The unique vehicle was designed to take advantage of aerodynamic “ground effect” by limiting maximum altitude to 10 feet. Interestingly, the FAA does not regulate vehicles that operate below 10 feet as “aircraft.”



2009

Steve Saint was awarded Popular Mechanics' Breakthrough Award for the Maverick, a flying dune buggy he invented to deliver supplies and medical care to remote areas. The Maverick's short take off and its ability to both fly and drive, makes it one of the more interesting and successful attempts at a flying car.

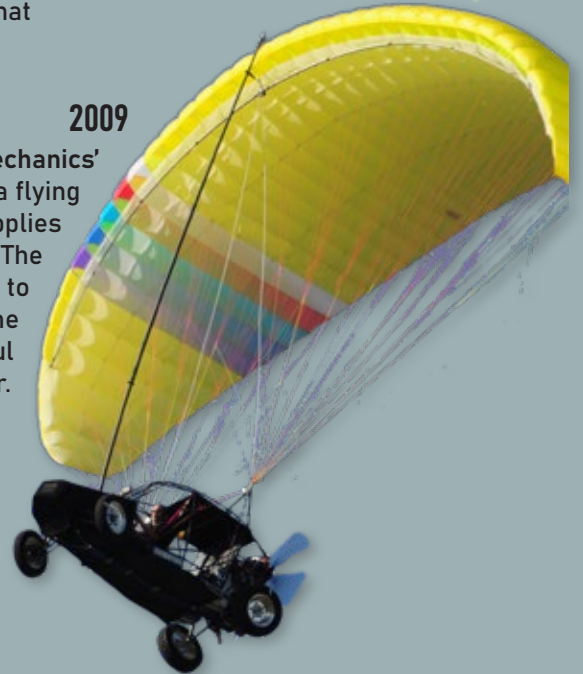

2012

Terrafugia Corporation's Transition “street legal” production prototype completed its first flight, and multiple phases of testing. The one-pilot, one passenger vehicle can reportedly go 70 mph on the road—and fit in the garage with its wings folded. In flight, the pusher propeller can attain a cruising speed of 107 mph.

Equipment includes a Dynon Skyview glass panel avionics system, an airframe parachute, and an optional autopilot.

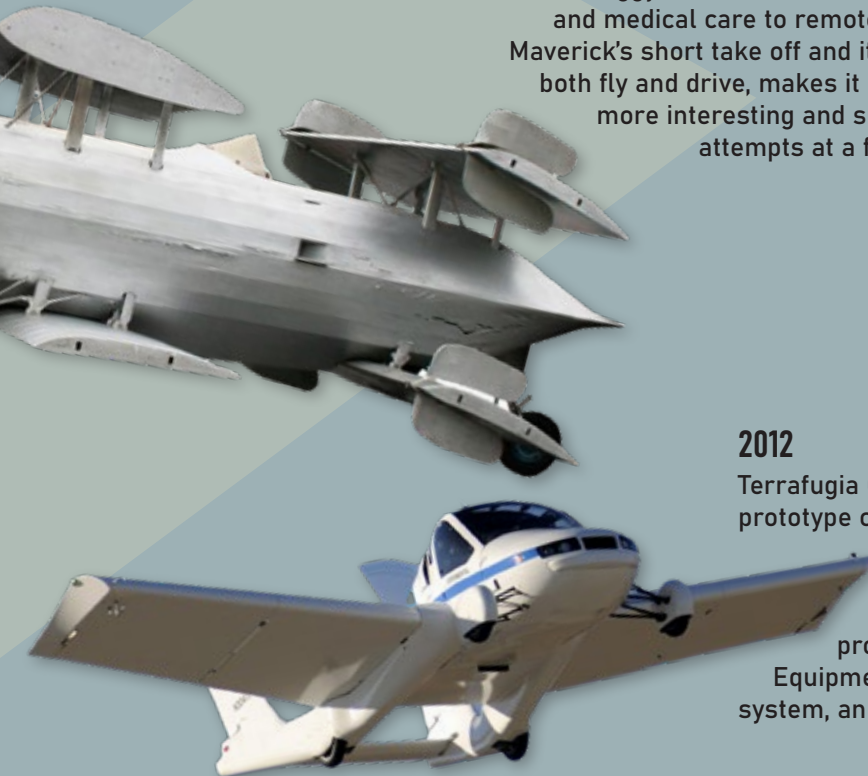

2015

The DARPA TX Transformer was, believe it or not, a proposed lift-and-cruise flying car for the U.S. Military. The objective of the Transformer program was to demonstrate a four-person road vehicle that could provide enhanced logistics and mobility by transforming into an aircraft.



TYPE CERTIFICATION OF **Air Taxi** INTERCONNECT SYSTEMS



Electrical Vertical Take-Off and Landing Aircraft (eVTOLs) and hybrids are being rolled out now for use in short-distance urban air transportation missions. Goals range from increased green energy utilization and improved travel time, to reduced ground traffic congestion. This article presents the principal electrical wire interconnect (EWIS) requirements for FAA / EASA type certification.

The intent of this article is to highlight electrical wire interconnect solutions for the emerging Urban Air Mobility (UAM) market, specifically targeting power distribution, avionics and sensor connections, and finally wire and cable management. The UAM, or Air Taxi industry, is focused on highly congested cities and population segments that require alternative solutions to ground transportation congestion. Many UAM solutions are focused on efficiently transporting small groups of people or single individuals in a node-to-node model, typically from high-traffic destinations such as airports, to hubs in city centers. The activity of autonomously transporting people through a controlled airspace and overflying urban areas with unique designs of eVTOL aircraft will require type certification from both the Federal Aviation Administration and the European Aviation Safety Agency including compliance with Federal Aviation Regulations part 23, 25, and 29.

Glenair offers a broad range of interconnect technologies that have been successfully implemented in aircraft required to meet FAR 25.1701 Electrical Wiring Interconnect System. These EWIS-compliant technologies were developed—using current-day materials and design principles—to ensure reliable and safe air transportation, free of electrical safety hazards. Qualification authorities will apply these or similar regulatory standards throughout the program development cycle (concept, preliminary design, critical design, initial build, power on, flight test and entry into service).

In fact, while some industry analysts anticipate the emerging UAM market, over the next 10–15 years, will enjoy some latitude in performance and safety requirements—in line with the unique low-altitude/autonomous operation nature of the technology—others argue that when the reality of transporting people over dense urban environments and the safety of both passengers and those living below the air space are fully considered, the safe and reliable operation of UAMs will require the use of electrical components that absolutely meet the stringent requirements associated with FAR 25.1701.

The most likely UAM operations scenario will be to limit the vehicles to operation in a lower-altitude airspace than larger commercial aircraft, with a likely 10,000 foot AGL (Above Ground Level) limitation. Lower-altitude operation (say, 1500 to 5000 feet) has the advantage of simplifying the insulation design requirements for distributing high-voltage power as well as reducing atmospheric thermal extremes to a range of -40°C to $+60^{\circ}\text{C}$.

Some air taxi designs are already in production and rollout in countries that are decidedly *not* in compliance with RTCA DO-160, and other FAA environmental conditions and test procedures for airborne equipment. However the likelihood that these requirements will be instituted as the baseline foundation for defining ongoing and future UAM flight requirements in North America and Europe goes without



question—including test methods to meet the unique environmental challenges associated with these high-cycle, dynamic air taxi missions—from basic considerations of galvanic corrosion and dissimilar metal design principles, to a wide range of other environmental constraints.

In this regard, the UAM environment may ultimately be considered as basically a modification to the DO-160 Category A4, which states:

Equipment intended for installation in a controlled temperature and pressurized location on an aircraft within which pressures are normally no lower than the altitude equivalent of 15,000 ft Mean Sea Level.

The category may also be applicable to equipment installed in temperature controlled but unpressurized locations on an aircraft that operate at altitudes no higher than 15,000 ft MSL.

Environment Constraints:

- Operating Low Temperature: -15° C
- Operating High Temperature: +70°C
- Ground Survival Low Temperature: -55°C
- Ground Survival High Temperature: +85°C
- Altitude: 4572 m (15,000 ft)
- Absolute Pressure (at 15kft): 57.18kPa (751.8mbars, 16.89 inHg, 429 mmHg)

Electrical Power Distribution System Voltage Requirements

The core technology for the electrical power distribution system in autonomous air taxis is based on the lithium-ion battery series/parallel design used in electric automobiles which, depending on the vehicle performance factors, produces a voltage of between 375Vdc to 800Vdc. An important benchmark in evaluating power distribution interconnect requirements can also be drawn from past successful NASA-instituted programs in which nominal voltage of 461Vdc (416Vdc – 525Vdc) with a maximum operating altitude of 15,000 ft. was achieved. Both of these power distribution models rely on lithium battery technology and are useful as a basis for selection of EWIS interconnect components suitable for the current generation of UAM lithium-ion HVDC power distribution systems.



Why is understanding the power system voltage so important? Higher voltages in aircraft operating environments characterized by broad temperature ranges, altitude, and pressure define wire insulation thickness and electrical connector geometry creepage and clearance dimensions.

Per AS50881, paragraph 6.6, "For DC, electrical cables can be used without ionization to a maximum voltage of 340 volts independent of the usual practical range of wire covering thicknesses. Under certain conditions (notably at high ambient temperatures and/or high altitude) some wire types may not be free from corona at rated voltage."

In certain applications of this type, Power Feeders (as opposed to mateable interconnects) combined with highly engineered power cabling, offer a viable solution which mitigates certain challenges associated with the use of conventional mil-spec insulated cables and connectors in high-power applications.

Glenair Duraelectric Power Feeders are in development for UAM applications with variable dielectric wall thicknesses IAW insulated conductor size and material and addressing the overall voltage / weight / flexibility requirements of the emerging UAM market. Glenair has several methods of terminating our aircraft-grade TurboFlex / Duraelectric cables for use in applications of this type. For applications that do require the ability to mate and un-mate—such as for electric motors—purpose-designed interconnects with proven performance in rigorous commercial airplane environments are preferred for compliance to FAA part regulations. Interconnects of this type typically incorporate design features that enable connectorization of high voltage, high current, as well as high-frequency power distribution systems providing safe and reliable protection of power lines from arcing or other safety hazards.

QUALIFICATION OF AIR TAXI INTERCONNECT SYSTEMS [CONTINUED]

Lightning Protection

UAMs operating in the 5,000-foot envelope must incorporate design features that mitigate the potentially harmful effects of lightning strike. Being a smaller vehicle equates to significantly larger energy levels that will need to be managed to prevent electrical system issues that could result in a flight safety event. As the UAM market transitions from the developmental phase and becomes integrated into the daily routines of the commuter, safety and reliability must be addressed in the system design.

The following Title 14 Code of Federal Regulations 25.1316 and Advisory Circular 20-136 cover general lightning strike and HIRF requirements for grounding and shielding in aircraft systems.

Summary of DOT/FAA/AR-04/13, General Aviation Lightning Strike Report and Protection Level Study

- Data in the database revealed that aircraft were most vulnerable to a lightning strike when flying in clouds and rain.
- The study found that the amount of lightning and HIRF protection in an aircraft had a significant impact on reducing the extent of damage resulting from a lightning strike.
- Compared to lesser or unprotected aircraft, lightning and HIRF-protected aircraft had a significantly lower percentage of electrical failures or electrical interferences due to lightning strikes.
- The percentage of electrical failures due to lightning strikes on HIRF-protected systems (2%) was much less than unprotected systems

(20%), thus indicating the effectiveness of HIRF protection.

A survey of U.S. commercial jets showed the majority of lightning strikes occur between altitudes of 5,000 feet (1,524 meters) and 15,000 feet (4,572 meters). With its lower proposed maximum operating altitude of 5,000 feet, UAM vehicles will nevertheless be required to design a robust shielding and grounding system to mitigate the damaging effects of lightning occurring even at this altitude.

The Federal Aviation Regulations for lightning strike are documented in the following parts which are dependent on the vehicle classification.

	Aircraft – General Aviation	Aircraft - Transport	Rotorcraft - Transport
Airframe	23.867	25.581	29.610
Fuel Systems	23.954	25.954	29.954
Other Systems	23.1309	25.1309	27.1309H

FAR 25.581 defines the requirements associated with lightning protection as follows:

- (a) The airplane must be protected against catastrophic effects from lightning.
- (b) For metallic components, compliance with paragraph (a) of this section may be shown by:
 - (1) Bonding the components properly to the airframe; or
 - (2) Designing the components so that a strike will not endanger the airplane.
- (c) For nonmetallic components, compliance with paragraph (a) of this section may be shown by:
 - (1) Designing the components to minimize the effect of a strike; or
 - (2) Incorporating acceptable means of diverting the resulting electrical current so as not to endanger the airplane.

EWIS design to meet lightning strike requirements IAW commercial transport systems will likely follow these guidelines:

- Wire bundle shielding – From traditional copper-plated strands to metallized polymer-core options to hybrid solutions, the



effective shielding of critical-path EWIS cabling from lightning strike and HIRF is a routine requirement in commercial aircraft. Addressing eVTOL lightning strike requirements with cable shielding solutions that do not add significantly to aircraft all-in weight will require ultra-lightweight designs and material selection including microfilament and metal-clad composite plastic material types.

- Ground straps and bonding jumpers are essential parts in establishing a common ground reference across multiple structural elements. Movable surfaces, hinges, panels, and electronics typically require ground strap technology. A single lightning strike can hit an aircraft with as much as 1,000,000 volts. Static electricity can charge an aircraft, particularly in cold and wet air, with enough electrical potential to result in a discharge that can fry EWIS wiring and avionics gear. Power storage systems (lithium battery-based) can also produce transient electrical current that can potentially damage electronic systems. Damage from these events is minimized and managed in aircraft through the use of electrical bonding. Flexible bonding straps are attached between equipment and airframes as well as between structural elements and flight control surfaces to conduct destructive electrical surges to ground or to bus bar components capable of absorbing significant amounts of transient voltage.
- Sensor wiring that routes along retractable landing gear in certain air taxi designs will be exposed to excessive currents that travel through the vehicle structure and through the landing gear struts before leaving the vehicle. Values as high as 20,000 amps can be experienced with a 80,000-amp strike. Shielded conduit and shielded cable assemblies can be used not only for physical protection but lightning protection as well in applications of this type.
- Low-resistance cable shield termination is a critical element in the overall EMC / Lightning assurance plan. The use of cable shield termination and strain relief backshells, as well as conductive feed-thru fittings and other EMC and wire management connector accessories have become absolute standards in commercial airframe applications and will necessarily find considerable use in the UAM market space.

Physical Separation of Individual Power Lines and Cable Bundles

EWIS designs, incorporating wire protection conduit and/or molded cable assemblies are routinely used to meet the FAR 25.1707 requirements. FAR 25.1707 System Separation states:

- (a) Each EWIS must be designed and installed with adequate physical separation from other EWIS and airplane systems so that an EWIS component failure will not create a hazardous condition. Unless otherwise stated, for the purposes of this section, adequate physical separation must be achieved by separation distance or by a barrier that provides protection equivalent to that separation distance.
- (i) EWIS must be designed and installed with adequate physical separation between the EWIS and flight or other mechanical control systems cables and associated system components.
- (j) EWIS must be designed and installed with adequate physical separation between the EWIS components and heated equipment, hot air ducts, and lines.
- (k) For systems for which redundancy is required, by certification rules, by operating rules, or as a result of the assessment required by §25.1709, EWIS components associated with those systems must be designed and installed with adequate physical separation.
- (l) Each EWIS must be designed and installed so there is adequate physical separation between it and other aircraft components and aircraft structure, and so that the EWIS is protected from sharp edges and corners, to minimize potential for abrasion/chafing, vibration damage, and other types of mechanical damage.

The use of suitable wire insulation, cable bundle overmolding, encapsulation in insulation-protected conduit, and other EWIS design methodologies are essential in meeting the FAR 25.1707 System Separation standard.



THERMODYNAMICS OF **Sci-Fi** POWER AND ENERGY

The twin challenges of “Energy Density” and “Lift” (plus that pesky “speed of light”) are the reasons why sci-fi space movie plots so often hinge on a fantastical future energy source that can transport characters quickly to far away planets. Complete the puzzle by matching the sci-fi energy source with its movie of origin.

1. Dilithium Crystals
2. Unobtanium
3. Flux Capacitor
4. Hyperdrive
5. Infinity (Tesseract) Stone
6. Miniature Arc Reactor
7. Zero-Point Energy
8. Iridium Nuclear Energy Cell
9. Wormhole
10. Jump Drives



INTERSTELLAR

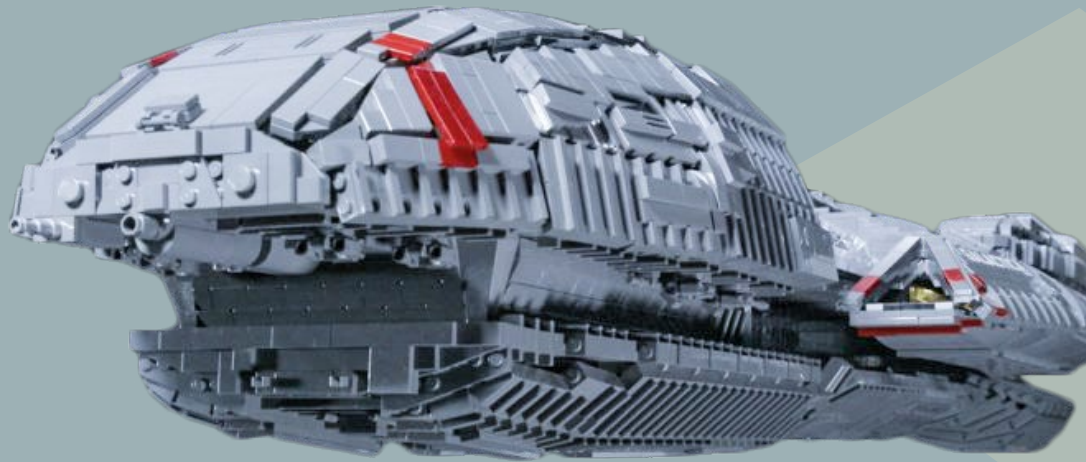

BATTLESTAR GALACTICA



THOR



STAR WARS





STAR TREK



AVATAR



THE TERMINATOR



IRON MAN



BACK TO THE FUTURE



STARGATE



Electric eVTOL Air Taxi Interconnect Solutions

Signature Interconnect Technology for Urban Air Mobility



ELECTRICAL POWER PROPULSION SYSTEM CONNECTORS, CABLES, AND ACCESSORIES



PowerLoad high-current, high-voltage power distribution connectors



PowerTrip high-density power distribution connectors



Super ITS and ITS Wing-Lock power connectors

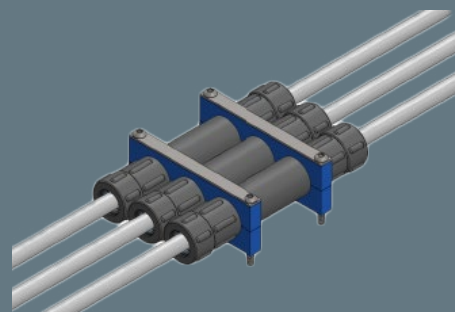

PowerBlock HV High Current Power Feeder System

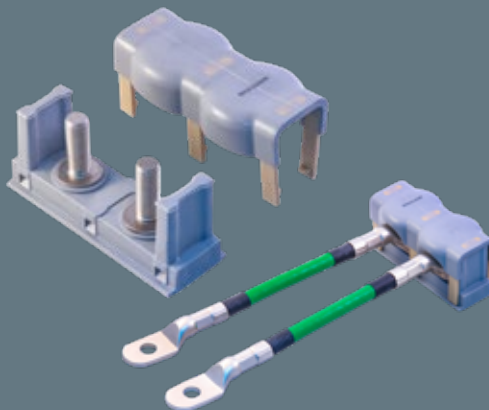

Duraelectric Terminal Block for enhanced safety power line termination and equipment grounding

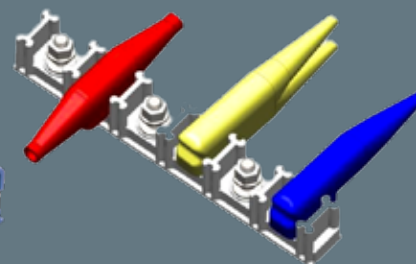

Duraelectric Terminal Hoods with color coding for multi-phase power



TurboFlex ultra-flexible power cables

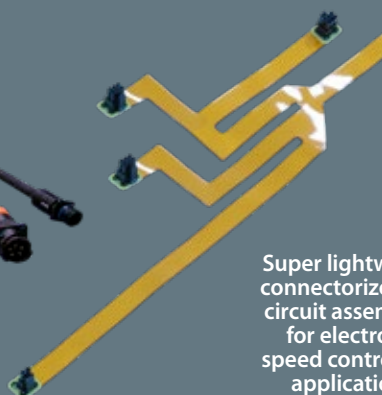

Super lightweight connectorized flex circuit assemblies for electronic speed control LRU applications



Autoshrink cold-action tubing and boots

LIGHTWEIGHT AVIONICS, FLIGHT DECK, ACTUATOR, AND SENSOR CONNECTORS



Series 806
micro miniature avionic and sensor
connector



SuperNine industry-standard
avionic and flight deck
connector



Series 791 and 792 Micro-Crimp
lightweight, high-density, and high-
speed datalink rectangular connectors

WIRE AND CABLE PROTECTION AND MANAGEMENT TECHNOLOGY



Bulkhead cable feed-thrus
with wire management grommets



Lightweight composite cable and
wire bundle strain reliefs



Solid and slit lightweight color-coded
wire protection conduit and fittings

SHIELDING AND GROUNDING SOLUTIONS FOR ELECTROMAGNETIC COMPATIBILITY (EMC)



GroundControl Earth Bond system
for composite fuselage
equipment grounding



Tubular braiding and MasterWrap
wraparound shielding for lightweight
shielding applications

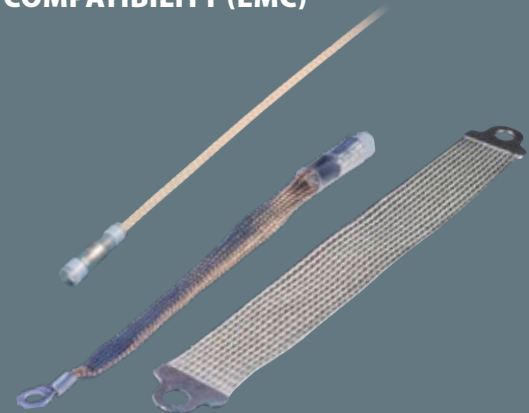

Lightweight, flexible
ground straps and HSTs

ELECTRICAL POWER
PROPULSION SYSTEM
CONNECTORS,
CABLES, AND
ACCESSORIES



High-voltage, high-current,
and high-frequency
interconnects for eVTOL
distributed power



PowerLoad™ is a high-vibration, high-temperature resistant connector series designed for aircraft power distribution in conventional, hybrid, and all-electric aerospace applications. An innovative combination of low-resistance contacts and a one-piece composite thermoplastic insulator—with aggressive contact cavity isolation—results in a reliable high-voltage (HV), high-current (HC), and high-frequency (HF) solution that optimizes wire-to-contact termination and weight reduction in power distribution cables. Designed for use in integrated drive generators, DC-to-AC inverters, electronic speed control applications (such as variable frequency (VFD) drive systems), PowerLoad is available in one, two, three, four, and six-contact layouts for both multiphase and high-frequency power designs. Removable wire-sealing grommet and wire separator allow for easy rear release of contacts and improved sealing of tape-wrapped wire. Matched TurboFlex power feeder cabling available for all insert arrangements.

- **High power output interconnects.** By way of example, the 28-6 layout connector is rated at 500 volts at altitude with a current of 45 amps per contact with 3 phase power in parallel at high frequency
- **Unique connector design** reliably manages partial discharge, arc tracking, altitude, temperature, and frequency stress factors, skin/proximity effect, and SWaP
- **Aluminum class** connectors are rated to 200°C operating temperature; passivated stainless steel designs rated to 230°C



HIGH PERFORMANCE PowerLoad™ Series



eVTOL electric propulsion system interconnect series

POWERLOAD™ EXPLODED VIEW

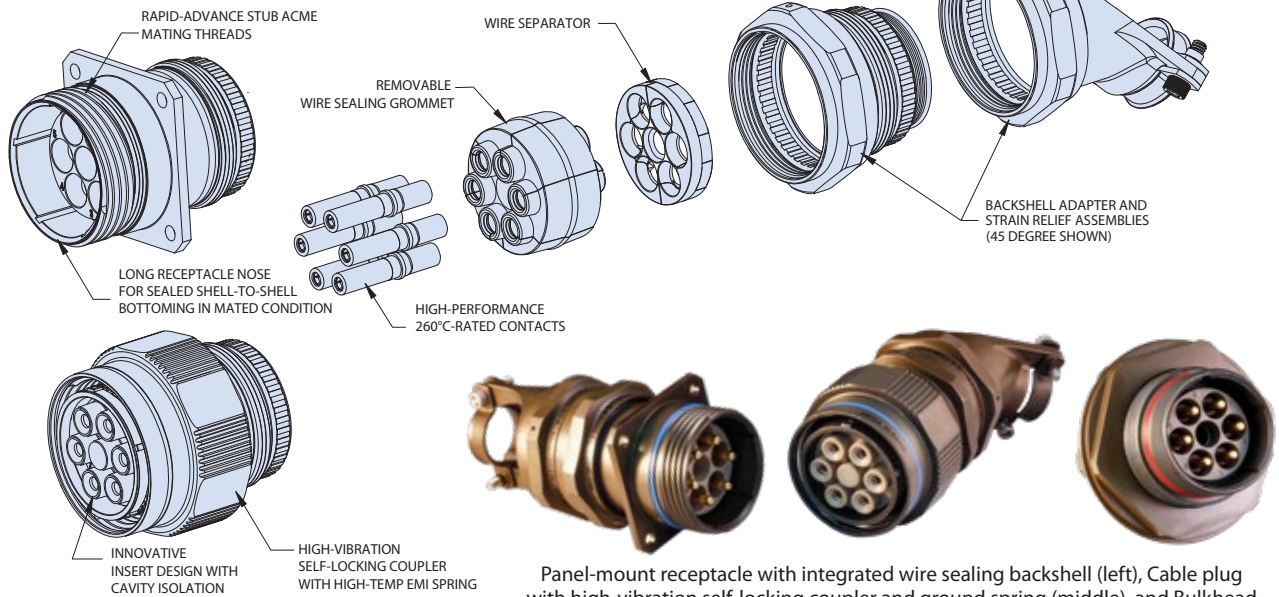

Panel-mount receptacle with integrated wire sealing backshell (left), Cable plug with high-vibration self-locking coupler and ground spring (middle), and Bulkhead feed-thru for firewall applications (right). All styles available with a range of contact sizes, #8, #4, #2, #1/0, #2/0, and #4/0.

POWERLOAD CONTACT ARRANGEMENTS FOR 3-PHASE HIGH-FREQUENCY POWER AND OTHER POWER DISTRIBUTION RATINGS AND FORMATS

 20-1 1X #1/0	 22-1 1X #2/0	 22-2 2X #8	 22-3 3X #8	 24-1 1X #4/0	 36-4 4X #1/0
 24-2 2X #4	 24-4 4X #8	 28-2 2X #2	 28-3 3X #2	 28-4 4X #4	
 28-6 6X #8	 32-2 2X #1/0	 32-3 3X #1/0	 32-4 4X #2	 36-2 2X #2/0	 40-3 3X #2/0

All PowerLoad contact arrangements fully supported with Glenair TurboFlex high-flexibility power feeder cabling in gauges from 16 AWG to 450 MCM.

ELECTRICAL POWER
PROPULSION SYSTEM
CONNECTORS,
CABLES, AND
ACCESSORIES



**POWER
TRIP™**

Series 970 PowerTrip high-density reduced size and weight power connectors—ideally suited for multi-phase brushless motor interconnection

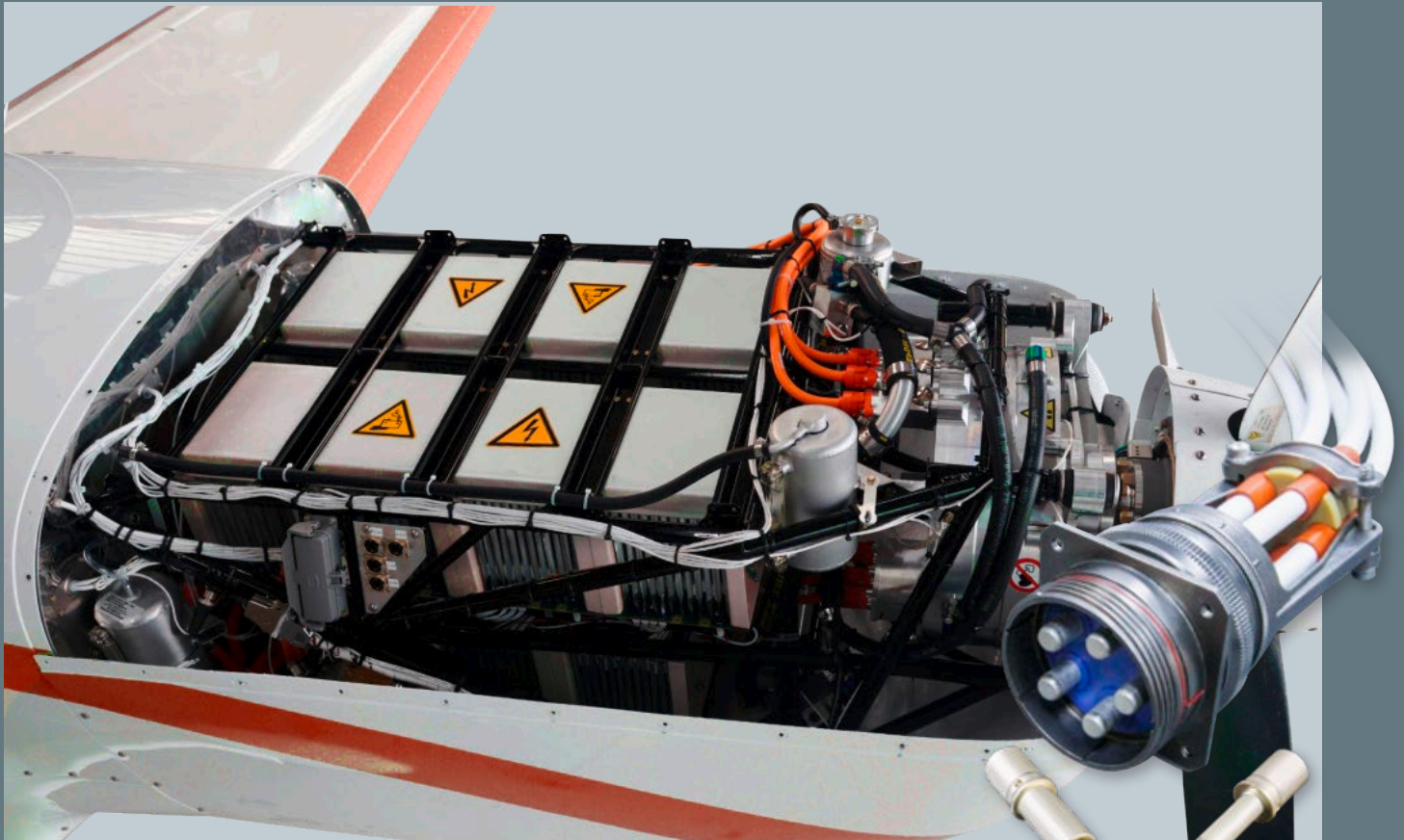

Lightweight plug with ratcheting coupling nut and low-resistance LouverBand contacts



Keyed receptacle with superior sealing and EMI shielding

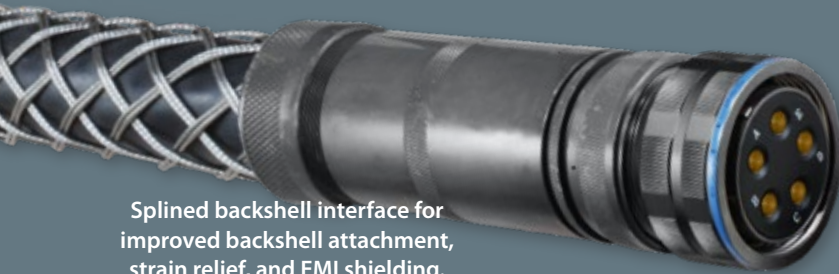

Splined backshell interface for improved backshell attachment, strain relief, and EMI shielding.

The Series 970 PowerTrip™ offers improved performance compared to industrial-grade power connectors including higher density, superior resistance to vibration and shock, lower resistance, higher kW peak output and durability. Designed explicitly for aerospace-grade power interconnect applications.

- Fast, easy mating with triple-start ACME thread: 360° turn for full mating
- Reduced size and weight compared to conventional industrial and/or aerospace solutions
- LouverBand sockets for improved current ratings; up to 2000 mating cycles
- Ratcheting coupling nut for secure mating and high vibration resistance
- Operating temperature -65° C to +200° C
- Hermetic and EMI filter options available

SERIES 970 PowerTrip™



High-density, high-performance power connectors

SERIES 970 POWERTRIP™ CONNECTOR STYLES



Plug
970-001



Square Flange
Receptacles
970-003



Jam Nut Receptacles
970-004



Cable Receptacles
970-005



Feed-Thru Bulkhead
970-006



Hermetic Feed-Thru
Bulkhead
970-007

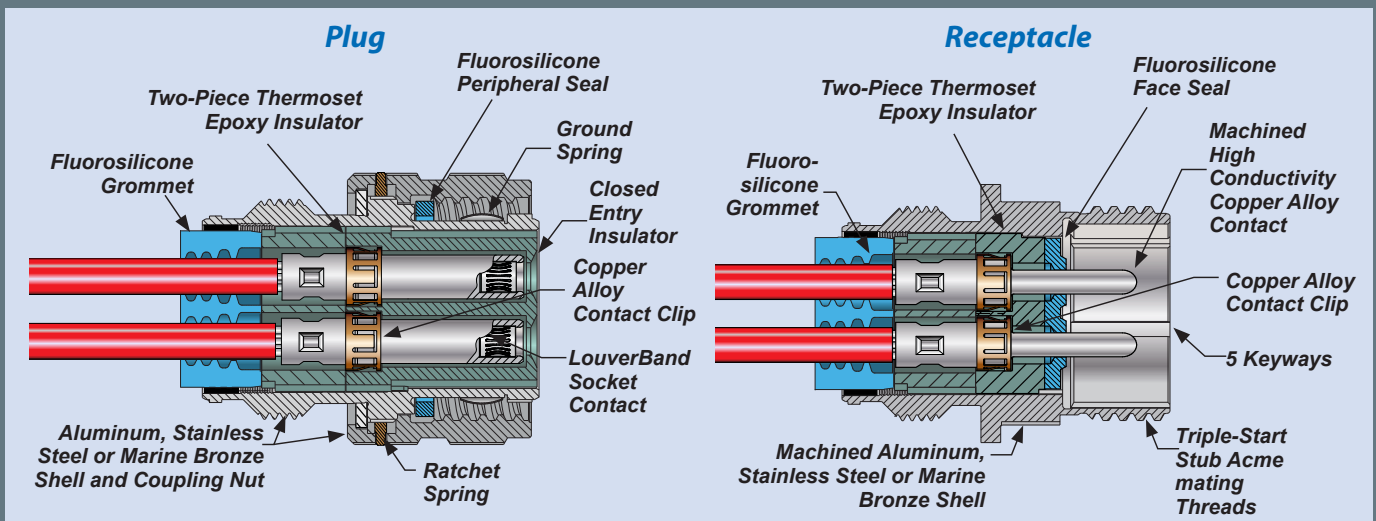

Series 970 PowerTrip™ Specifications	
Current Rating	Up to 225 A.
Dielectric Withstanding Voltage	2000 VAC
Insulation Resistance	5000 megohms minimum
Operating Temperature	-65° C. to +200° C.
Shock	300 g.
Vibration	37 g.
Shielding Effectiveness	65 dB minimum from 1GHz to 10GHz.
Durability	2000 mating cycles

CONTACT RESISTANCE AFTER 1000 MATING CYCLES

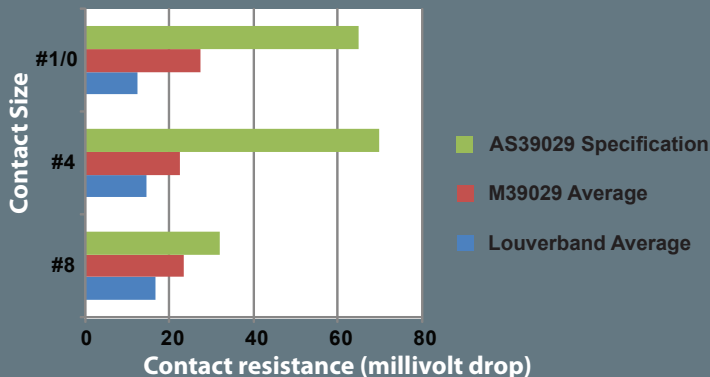

ABOUT THE POWERTRIP™ CONTACT SYSTEM

Series 970 contacts are precision-machined using high conductivity copper alloy. A stamped and formed spring ("LouverBand") is installed into the socket contact. The spring is made from 6 mil copper alloy. Testing has demonstrated that this contact system outperforms conventional industrial and aerospace-grade contact systems. The LouverBand spring provides many points of electrical contact with the mating pin, as opposed to a few "high spots" on a conventional four-finger contact as shown in the figure below. The size #8 Powertrip socket contact has a total of 18 louvers. The #4 has 27 louvers, and the #1/0 has 42 louvers. The LouverBand design offers lower voltage drop for reduced joule heating. In addition to its electrical advantages, the LouverBand also is mechanically superior to conventional four-finger contacts. The LouverBand spring has consistent, stable normal force, even when subjected to thousands of mating cycles and temperature extremes.



Conventional contact on the left,
LouverBand contact on the right

LouverBand socket
contact cutaway

ELECTRICAL POWER
PROPULSION SYSTEM
CONNECTORS,
CABLES, AND
ACCESSORIES



The ultra
flexible and
rugged power
cable solution



photo: Matti Blume
courtesy Wikipedia

TurboFlex® power distribution cables are constructed from highly flexible conductors and high-performance insulation to produce cables ideally suited for applications where flexibility, durability, and weight reduction are required. Amazingly durable and flexible—especially in cold weather—the 16 AWG to 450 MCM TurboFlex cable features high strand-count rope-lay inner conductors made with tin-, nickel- and silver-plated copper. TurboFlex is jacketed with Glenair’s unique Duraelectric™ compound that provides outstanding flexibility and resistance to environmental and chemical exposure. Duraelectric is also low smoke, zero halogen. Long life and performance are critical in power distribution applications. TurboFlex, with its flexible conductors and durable jacket delivers both.



Available in a broad
range of gauges,
16 AWG to 450 MCM



◀ Duraelectric™ is the high-performance TurboFlex® jacketing material perfectly suited for immersion, chemical or caustic fluid exposure, temperature extremes, UV radiation and more—available in a broad range of colors including safety orange



Many sizes in-stock and available for
immediate, same-day shipment. No
minimums!

TurboFlex ultra-flexible power distribution cable



Environmental performance · voltage rating data
Duralectric™ jacketing specifications and colors

TURBOFLEX CABLE APPLICATION EXAMPLE



This multibranch TurboFlex power and data interconnect assembly for a ruggedized defense application demonstrates the remarkable flexibility and minimal bend radius of large form-factor (up to 450 MCM) TurboFlex cable. Example shown features UV- and chemical-resistant Duralectric jacketing in FED-STD 595C Safety Orange.



Ultra flexible rope lay construction
TurboFlex bend radius is 3X the
outer diameter

Voltage Ratings			
P/N	Jacket Wall Thickness	AC Voltage Rating, RMS	DC Voltage Rating
961-004	.032"	2000	2800
961-003	.062"	3000	4200
961-002	.093"	3500	4900
961-001	.125"	4500	6300

Standard catalog product is available with either Tin/Copper, Silver/Copper, or Nickel/Copper conductors, with standard Duralectric™ jacketing in four wall thicknesses. Consult factory for special formula Duralectric™ K, F, and C configurations

Jacketing Options		
Weatherproof, halogen free, flame resistant, functional to 260°C		
0	Black	Fed-Std-595C #17038
1	Desert Tan	Fed-Std-595C #33446
2	Red	Fed-Std-595C #11120
3	Orange	Fed-Std-595C #12300
4	Yellow	Fed-Std-595C #13591
5	Green	Fed-Std-595C #14193
6	Blue	Fed-Std-595C #15125
7	Violet	Fed-Std-595C #17142
8	Gray	Fed-Std-595C #26270
9	White	Fed-Std-595C #17875

Consult factory for other specific Fed Std colors

Abrasion Resistance	Good
Wear Resistance	Good
Flame Resistance	Excellent
Sunlight Resistance	Excellent
Flex Resistance	Excellent

TURBOFLEX® WITH DURAELECTRIC™ JACKETING: ENVIRONMENTAL PERFORMANCE

Temperature rating: -60°C to 260°C
Halogen free per IEC 60614-1
Accelerated weathering and simulated solar radiation at ground level per IEC 60068-2-5; 56 Days exposure, suitable for greater than 50 years of service in direct sunlight
Flame resistant per IEC 60614-1
Flame resistant per UL 1685, section 12 (FT4/IEEE120), vertical-tray fire-propagation and smoke release test
Flame resistant per FAR 25.853 (A) amendment 25-116, appendix Fpart I (A) (1) (i), 60 second vertical burn test
Limiting oxygen index of 45 per ISO 4589-2:1999
Low smoke per NES 711, smoke density of 11.75
Smoke density class F1 per NF F 16-101 IAW DIN EN 60695-2-11:2011

Low smoke toxicity per NES 713, tested value of 1.9
Fungus rating of 0 per MIL-STD-810g method 508.5. Does not support fungal growth
ASTM D624, die B tear strength, 150 pounds per inch minimum on jacket material
Low outgassing per ASTM e595 after post curing, TML .06%, CVM .006%, WVR .02%
Resistant to fluids per MIL-STD-810F, method 504 JP-8 per MIL-DTL-83133 (NATO type 34)
MIL-H-5606 hydraulic fluid
MIL-PRF-23699 lubricating oil
MIL-C-85570 cleaner
TT-I-735 Isopropyl alcohol
AMS 1432 potassium acetate deicing/anti-icing fluid
MIL-C-87252 coolant
Amerex AFF fire extinguishing foam

LIGHTWEIGHT
AVIONICS,
FLIGHT DECK,
ACTUATOR AND
SENSOR CONNECTORS

SERIES
806
MIL-AERO

Advanced performance,
reduced size and weight
connector series IAW
MIL-DTL-38999

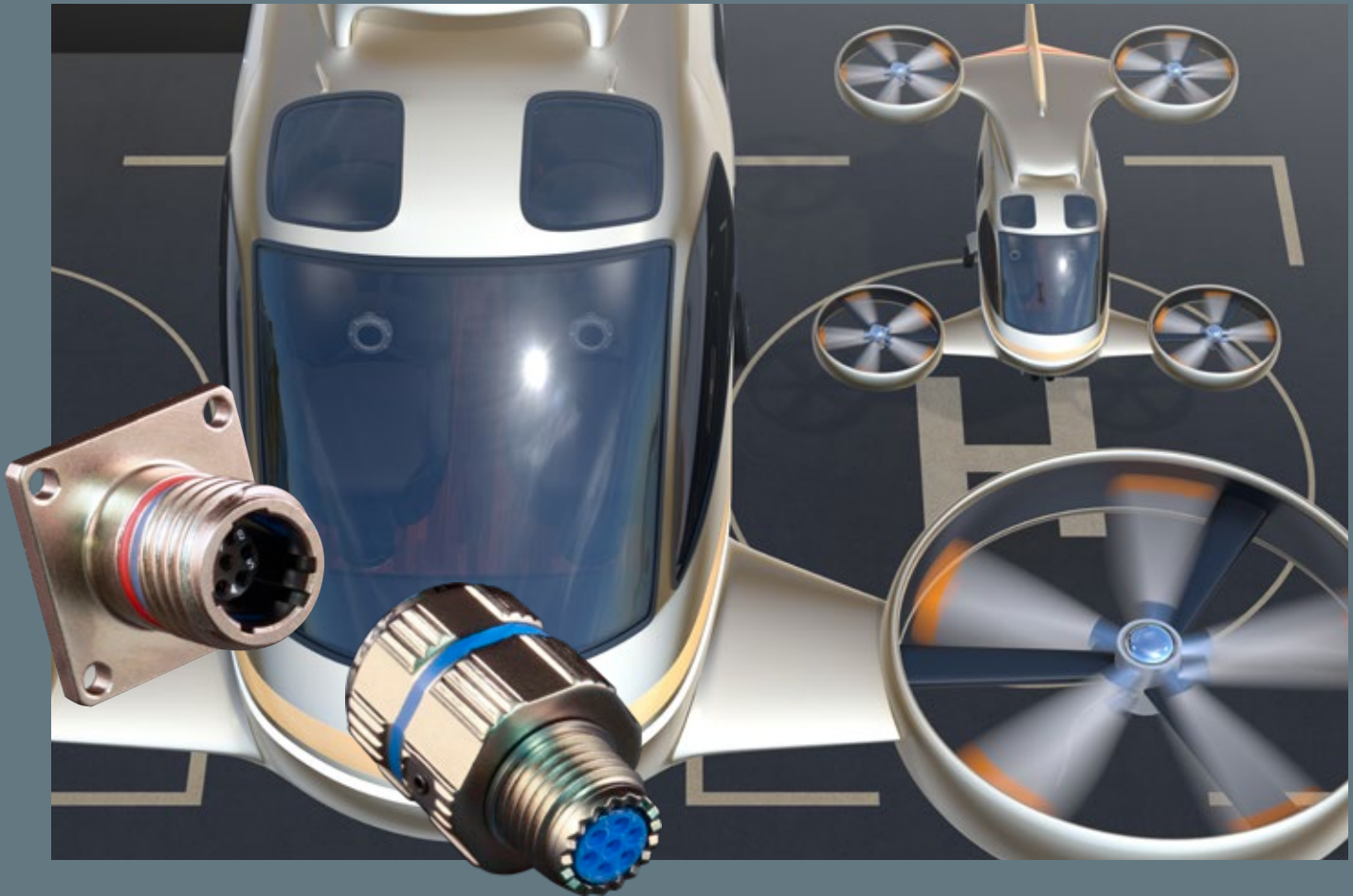

Series 806 offers significant size and weight savings while meeting key performance benchmarks for a broad range of eVTOL / UAM applications including sensors, flight navigation avionics in piloted vehicles, electronic speed controllers, and more. Designed for broad use in harsh vibration, shock, and environmental aircraft zones—as well as high-altitude, unpressurized zones with aggressive voltage ratings and altitude immersion standards—the Series 806 Mil-Aero features numerous design innovations including durable mechanical insert retention, radial and triple-ripple grommet seals. Its reduced thread pitch and re-engineered ratchet prevent decoupling problems, particularly in small shell sizes, solving one of the major problems of shell size 9 and 11 MIL-DTL-38999 Series III connectors.

SIZE AND WEIGHT SAVING SOLUTIONS: CATALOG OR CUSTOM

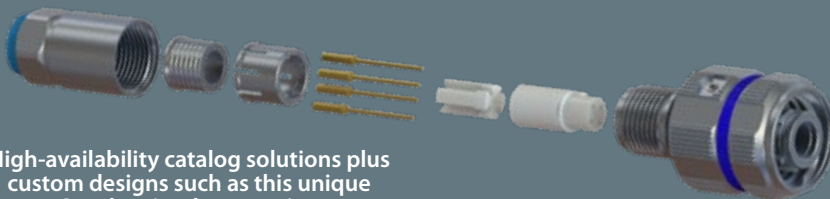

High-availability catalog solutions plus custom designs such as this unique Quadrax implementation

- Next-generation small form factor aerospace-grade circular connector
- Designed for harsh application environments including air taxi sensors, flight navigation electronics, and flight deck avionics
- Integrated anti-decoupling technology
- High density 20HD, 22HD, RF, and high-speed contact arrangements
- Hermetic and filter versions
- +200°C temperature rating

Series 806 Mil-Aero Micro Miniature Circular Connectors



for rugged aerospace / UAM applications

SERIES 806 MIL-AERO: FEATURES / SPECIFICATIONS

- High-density #20HD and #22HD arrangements for reduced size and weight
- Supported wire sizes:
#20HD contacts 20–24 AWG
#22HD contacts 22–28AWG
- Dielectric withstanding voltage
#20HD layouts: 1800 Vac
#22HD layouts: 1300 Vac
- Reduced pitch triple-start modified anti-decoupling stub ACME mating threads
- +200°C operating temperature
- “Triple ripple” wire sealing grommet (75,000 ft. rated)
- Snap in, rear release crimp contacts
- Metal contact retention clips
- Integral Nano-Band shield termination platform
- EMI shielding effectiveness per D38999M para. 4.5.28 (65 dB min. leakage attenuation @ 10GHz)
- 10,000 amp indirect lightning strike
- MIL-S-901 Grade A high impact shock

E1 Ochito®

GLENAIR SIGNATURE HIGH-SPEED SIZE #8 OCTAXIAL CONTACTS

- 10GbE, SuperSpeed USB, and multi-gigabit shielded pairs
- Universal drop-in for keyed size #8 connector cavities
- Data-pair isolation for optimal signal integrity
- 50% cable / contact reduction compared to Quadrax



SERIES 806 MIL-AERO PLUG

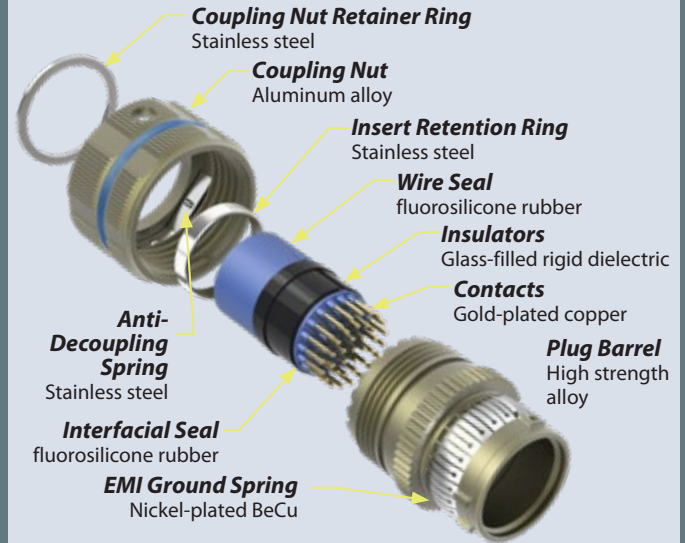

SERIES 806 MIL-AERO RECEPTACLE

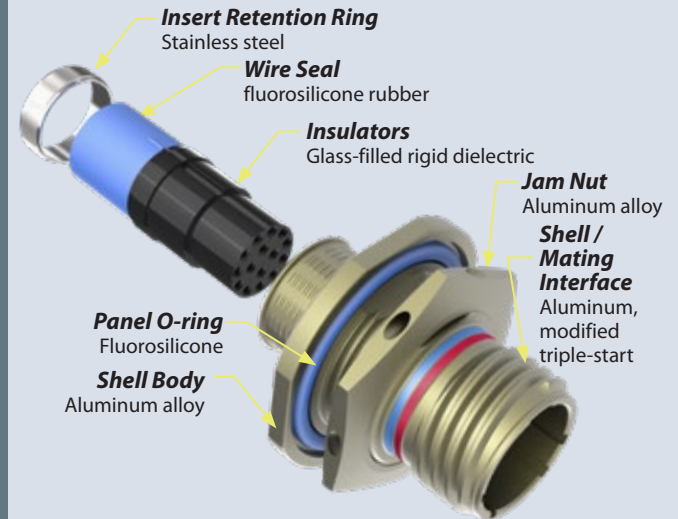

SMALLER AND LIGHTER WITH EQUAL D38999 PERFORMANCE?

High-Density Layouts
Twice as many contacts in a smaller package

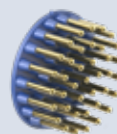

“Top Hat” Insulator
High voltage rating, foolproof alignment



Triple Ripple Wire Seal
Reliable 75,000 ft. altitude immersion



LIGHTWEIGHT
AVIONICS,
FLIGHT DECK,
ACTUATOR AND
SENSOR CONNECTORS

SuperNine®

The advanced-performance “fly-by-wire”
connector series



SuperNine® is the aerospace industry’s most mature and complete power, signal, high speed, and high-frequency RF interconnect. Ideally suited for a broad range of eVTOL applications, from an I/O interface role on electronic controllers, processors, and actuators, to targeted use on sensors and avionics gear, the SuperNine provides a level of reliability and safety not found on industrial-grade connectors. SuperNine® offers outstanding durability, sealing, ease of shield termination, a broad range of PC tail configurations, environmental and hermetic bulkhead feed-throughs, connector savers, as well as off-the-shelf EMI/EMP filter connectors and more—all supported with Glenair’s well-established reputation for service, support, and fast turnaround.



Glenair SuperNine connectors in action, shown here in a harsh-environment overmolded cable assembly for a military jet application. Glenair supplies both discrete connectors as well as turnkey interconnect assemblies for all our high-performance connector series.

Designed for use in rugged vibration and shock applications, Glenair SuperNine is the only D38999-type series connector to pass the Bell Helicopter 299-100-B29 vibration testing

SERIES 23

SuperNine®

MIL-DTL-38999 Series III Type

Lighter, faster, stronger interconnects for Urban Air Mobility



RUGGED, HIGH VIBRATION AND SHOCK COUPLING AND MATING TECHNOLOGY

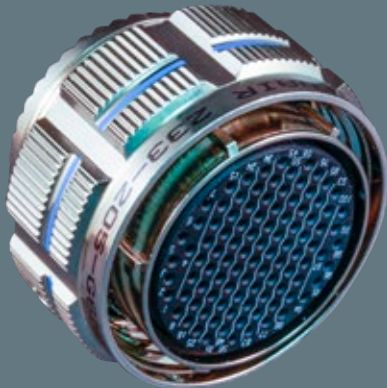

Anti-decoupling, high vibration ratcheting coupling nut for ultimate safety and reliability



Triple-start stub ACME mating thread profile for fast mate and demate during maintenance cycles



Special cable and receptacle connector go-betweens (Sav-Con®s) for critical connector protection

BROAD RANGE OF PC TAIL STANDOFF DESIGNS FOR I/O-TO-BOARD APPLICATIONS



Dual standoff design for superior resistance to vibration and shock

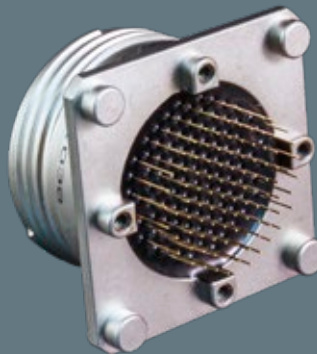

Threaded standoff design for easy attachment to boards

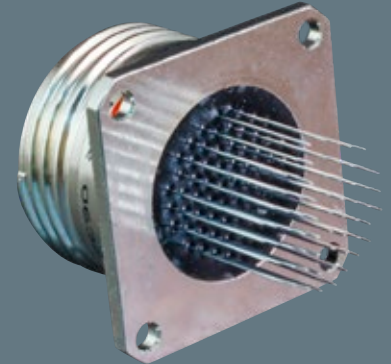

Ultra low-profile flat configuration for reduced package size applications

HIGH-SPEED AND RF DESIGNS FOR SENSORS AND SATELLITE UPLINK DATA COMMS

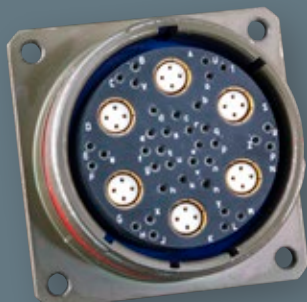

Industry-standard Quadrax-equipped layouts for signal and high-speed data

El Ochito®



Ultra-light weight Octaxial contacts for 10Gb data transfer per contact

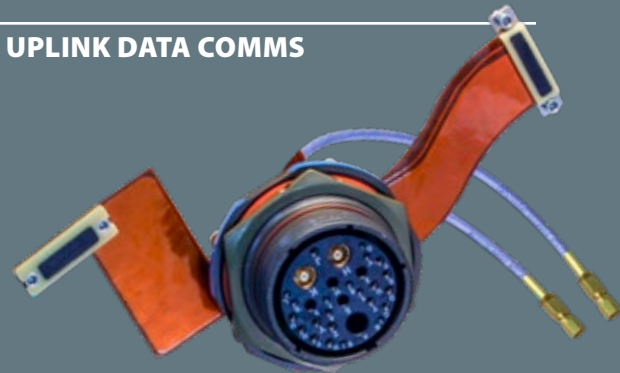

High-frequency RF designs for satcom communications

LIGHTWEIGHT
AVIONICS,
FLIGHT DECK,
ACTUATOR AND
SENSOR CONNECTORS



High-reliability rack-and-panel
rectangular connectors for aircraft
electronic systems



Series 791: the high-performance
signal, power, and RF rack-and-panel
rectangular connector

High-density rectangular connectors may see considerable use in lightweight vertical-takeoff air taxis as they facilitate the overall miniaturization of electronic equipment, including avionics gear and flight deck displays. Given the need for shielded / grounded interconnects that can meet EMC and lightning strike requirements, air taxis will find higher-performance solutions, such as the Series 791 Micro-Crimp, will provide a surer path to certification than automotive-grade rectangulars such as the ubiquitous D-sub. The Micro-Crimp family of rectangular connectors features two designs that are ideally suited for signal, high-speed data, and RF applications. The Series 791

incorporates dual-lobe polarization, scoop-proof shells, integrated EMI grounding fingers, and is qualified for a wide range of aerospace applications. This precision-machined rectangular connector is designed for higher levels of reliability and safety than may be achieved with commercial-grade solutions.



- Next-generation small form factor aerospace-grade rectangular connector
- Scoop-proof recessed pin contacts
- 37 arrangements, 12 shell sizes for the ultimate in versatility
- Rugged aluminum alloy dual-lobe shell
- Environmental
- EMI shielded
- Blind mating



The next-generation *high-speed* miniature rectangular for demanding avionic and flight control applications



El Ochito[®]

Designed for use with El Ochito high-speed Octaxial contacts

- High-speed Ethernet, USB 3.0, HDMI
- Printed circuit board and cable connectors
- Scoop-proof interface
- 12 arrangements, 6 shell sizes for the ultimate in versatility
- Rugged aluminum alloy dual-lobe polarized shells
- Environmentally sealed
- Integrated EMI shielding and grounding
- Blind mating

The Series 792 connector brings high-speed datalink capability to the Glenair Series 79 rectangular connector family. Size 8 cavities accept standard Quadrax and El Ochito datalink contacts. The 792's small size and blind-mate capability makes it a perfect choice for radar sensors, communications gear, avionics, and instrumentation. Board mount versions feature straight and right-angle terminals for easy I/O-to-board termination.

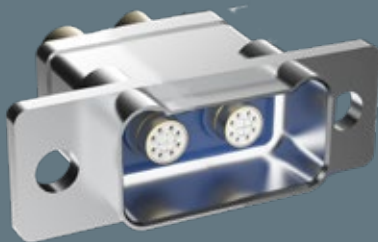

The Series 792 is an aerospace-grade miniature rectangular connector for high-speed datalinks including 10Gb Ethernet, USB 3.0, and HDMI. The Series 792 features precision-machined (not stamped!) aluminum alloy shells with dual lobes for robust polarization. The 100% scoop-proof interface protects contacts from damage. An integrated ground spring reduces susceptibility to electromagnetic interference. Hybrid layouts with discrete size #23 signal or power contacts add additional versatility.

WIRE AND CABLE
PROTECTION
AND MANAGEMENT
TECHNOLOGY

SWING ARM®

3-in-1 lightweight composite backshell with
optional drop-in braid termination follower

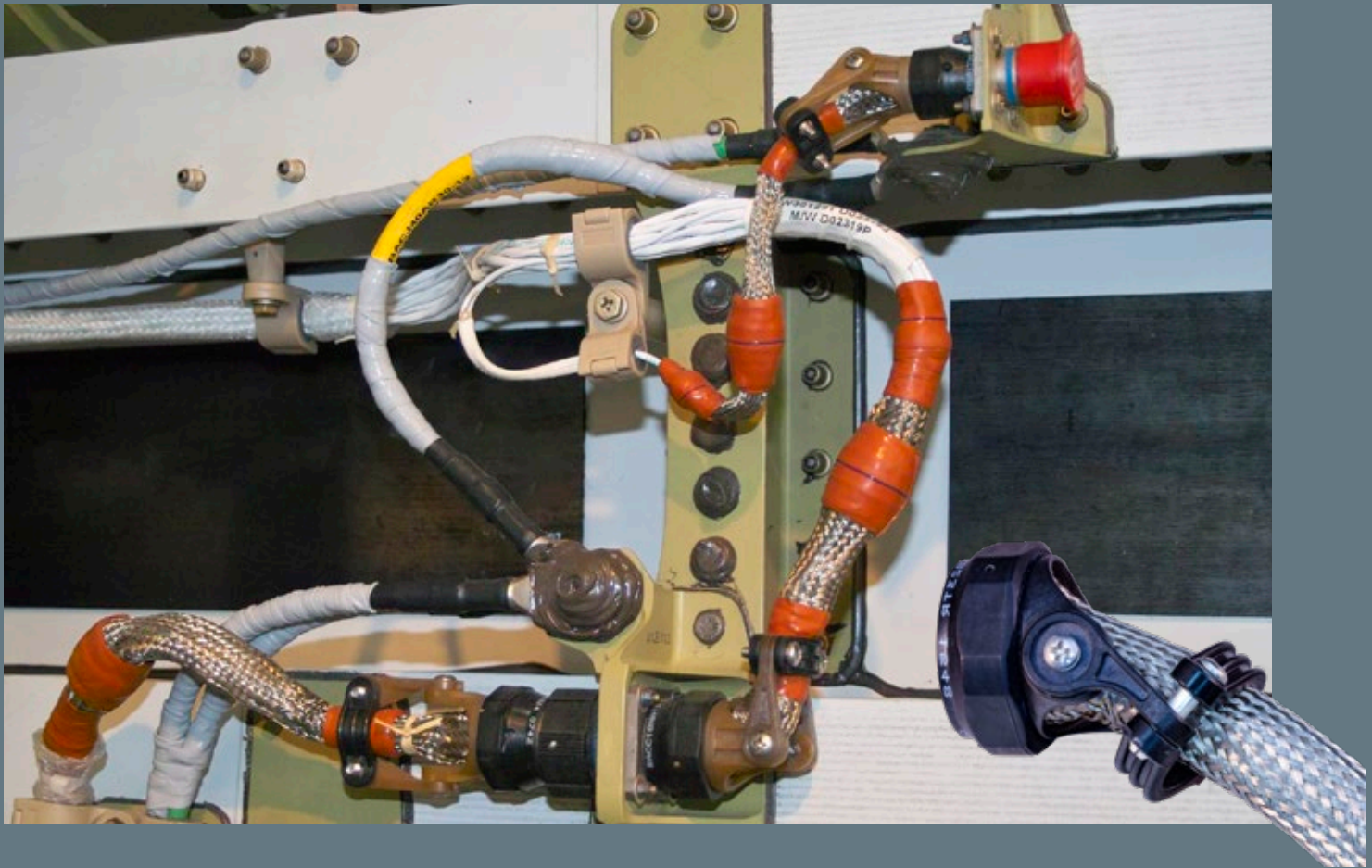

Glenair's composite Swing-Arm® strain relief backshell is a lightweight and corrosion-free cable clamp with cable shield termination options for a wide range of EWIS applications. This innovative backshell has become the standard shield termination device for weight reduction in both military and commercial airframe applications. Made from temperature-tolerant composite thermoplastic, rugged Swing-Arm® backshells offer easy installation, long-term performance, and outstanding weight and SKU reduction. Performance tested to stringent AS85049 mechanical and electrical standards and available for all commonly-specified mil-standard and commercial cylindrical connectors including MIL-DTL-38999, SuperNine, and Series 806 Mil-Aero.

Introducing Swing-Arm FLEX®, Glenair Next- Generation Composite Swing-Arm® Strain Relief

- Significant weight reduction: no saddle bars or hardware
- Rapid assembly: cable self-centers on bundle, little or no wrapping tape required
- Braid sock and drop-in band termination follower versions for EMI/RFI applications
- Internal conductive ground path

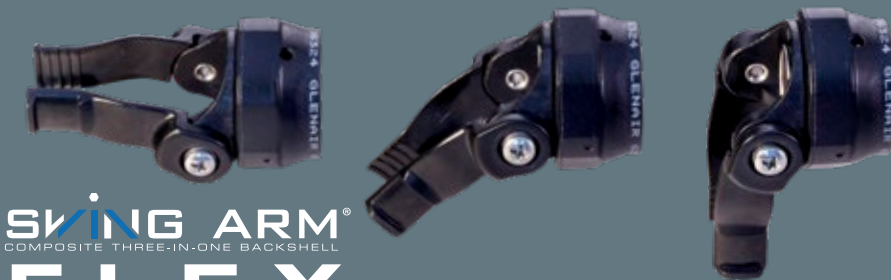

SWING ARM®
COMPOSITE THREE-IN-ONE BACKSHELL
FLEX

User-configurable straight, 45°, and 90° cable routing

Swing-Arm 3-in-1 lightweight composite thermoplastic strain-relief and EMI/RFI shield termination backshell



THREE STYLES OF SWING-ARM STRAIN RELIEF CLAMPS

- Style A - standard mouth, rigid saddle bars
- Style B - wide mouth (for larger cable diameters), rigid saddle bars
- Style C Swing-Arm FLEX - no saddle bars, self-centering round cable strain relief

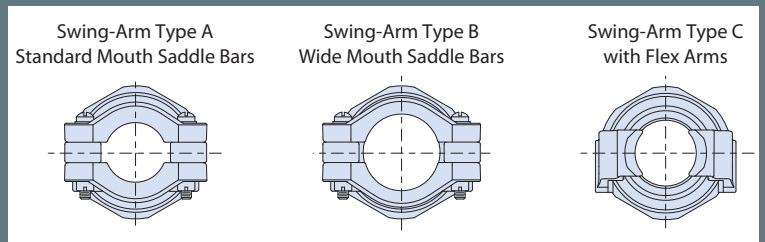

SWING-ARM VERSATILITY: FROM SIMPLE CABLE STRAIN RELIEF TO EMI/RFI SHIELD TERMINATION

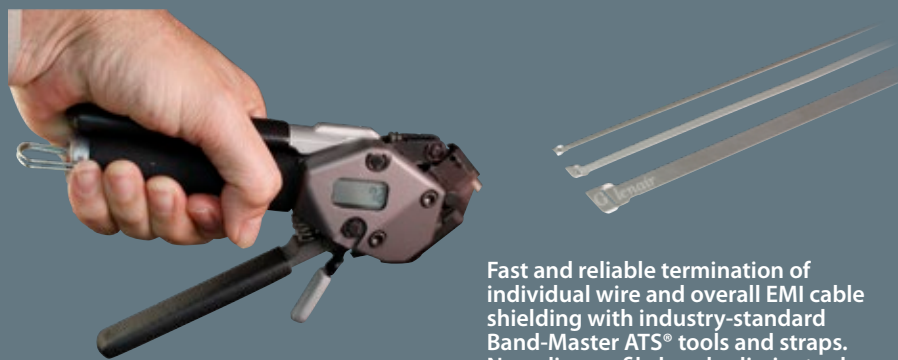

Fast and reliable termination of individual wire and overall EMI cable shielding with industry-standard Band-Master ATS® tools and straps. New slim profile bands eliminate sharp strap cutoff for improved safety.

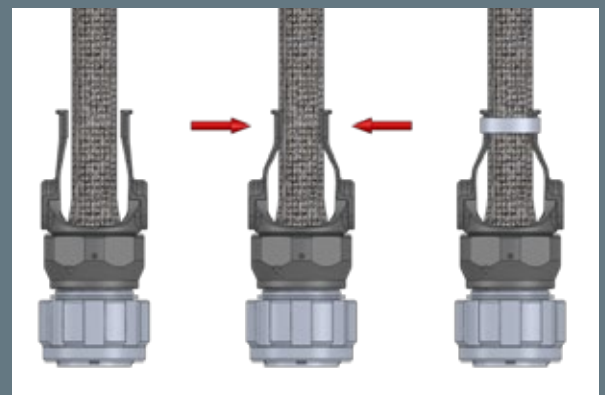

DROP-IN FOLLOWER FOR DIRECT TERMINATION OF OVERALL OR INDIVIDUAL WIRE SHIELDING

Two drop-in-follower designs, solid and slotted are available for all Swing-Arm styles (A, B, and C).



SWING-ARM AND SWING-ARM FLEX WITH OPTIONAL INTEGRATED SHIELD SOCK

For fast and reliable EMI/RFI shield termination of individual wire and overall cable shielding



SWING-ARM SHIELD SOCK TERMINATION OPTIONS, STANDARD SPLIT RING OR STARSHIELD STAR



Termination of shield sock to cable shield with split support ring

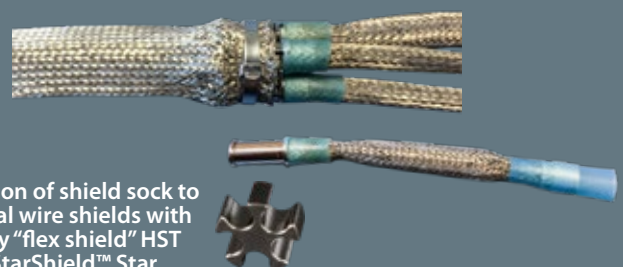

Termination of shield sock to individual wire shields with auxiliary "flex shield" HST and StarShield™ Star

SHIELDING
AND GROUNDING
SOLUTIONS FOR
ELECTROMAGNETIC
COMPATIBILITY

ARMORLITE™

Microfilament nickel-clad expandable
stainless steel EMI/RFI braided shielding



Save weight and ensure safe and reliable performance on every flight. All-Up-Weight (AUW) has met its match: ArmorLite™ microfilament stainless steel braid saves significant weight compared to standard plated copper shielding. By way of comparison, 100 feet of 5/8 inch ArmorLite™ is more than four pounds lighter than standard plated copper shielding used in EMI/RFI and lightning strike protection.

ArmorLite™ is an expandable, flexible, high-strength, conductive stainless steel microfilament braid material designed for use as EMI/RFI shielding in high-performance wire interconnect systems. ArmorLite™ is packaged in a wide range of formats including bulk expandable shielding, mesh tape, turnkey backshell shield sock assemblies, factory overbraiding, ground straps, HSTs, and more. ArmorLite™ offers superior temperature tolerance compared to other lightweight tubular braided shielding including microfilament composite technologies. New ArmorLite™ CF offers advanced



New enhanced corrosion resistance ArmorLite™ CF

corrosion protection compared to all other shielding types with comparable electrical performance due to its innovative combination of conductive copper microfilament and stainless steel cladding.

- Ultra-lightweight EMI/RFI braided sleeving for EMC and lightning strike applications
- Best performing metallic braid during lightning tests (IAW ANSI/EIA-364-75-1997 Waveform 5B)
- Microfilament stainless steel: 70% lighter than NiCu A-A-59569/QQB575
- Outstanding EMI/RFI shielding and conductivity
- ArmorLite™ CF with enhanced corrosion protection
- Superior flexibility and “windowing” resistance: 90 to 95% optical coverage
- 70,000 psi (min.) tensile strength

LIGHTWEIGHT, FLEXIBLE
ArmorLite™ Microfilament Braid
for EMI/RFI Shielding Applications



ARMORLITE™ SHIELDING SOLUTIONS AND PACKAGING



Factory overbraided



Mesh tape



Integrated shield sock

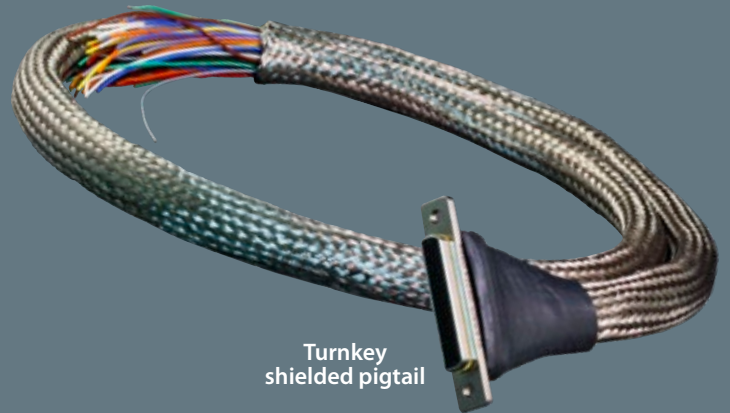

Turnkey shielded pigtail

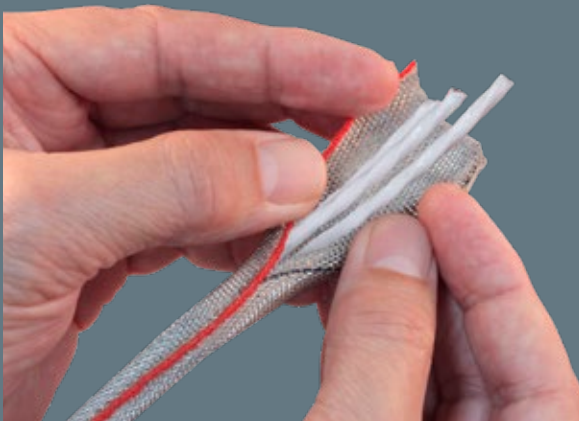

MasterWrap



Bulk expandable shielding



Lightweight, flexible ground straps

SHIELDING
AND GROUNDING
SOLUTIONS FOR
ELECTROMAGNETIC
COMPATIBILITY

Ground Straps for for electrostatic discharge,
lightning strike and power equipment
grounding

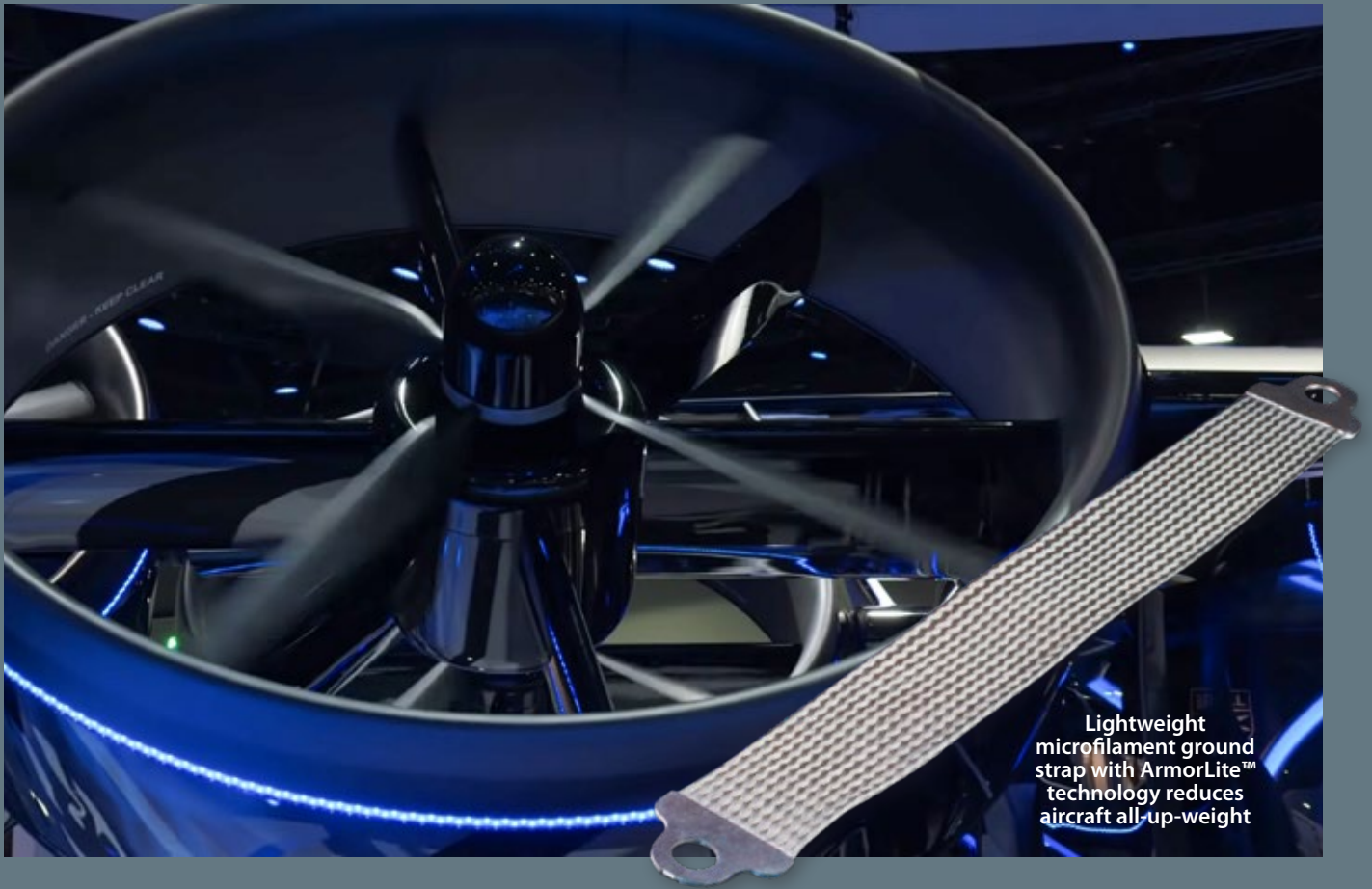

Lightweight
microfilament ground
strap with ArmorLite™
technology reduces
aircraft all-up-weight

A single lightning strike can hit an aircraft with as much as 1,000,000 volts. Static electricity can charge an aircraft, particularly in cold and wet air, with enough electrical potential to result in a discharge that can fry avionics gear and disrupt electric motor operation. Power generation systems (batteries, motors, inverters, etc.) can also produce transient electrical current that can damage adjacent electronic systems such as electronic controllers and fly-by-wire systems.

Damage from these events is minimized and managed in aircraft through the use of electrical bonding. Flexible bonding straps are attached between equipment and airframes as well as between structural elements and flight control surfaces to conduct destructive electrical surges to ground or to bus bar components capable of absorbing significant amounts of transient voltage

Glenair has designed and supplies a broad range of braided and solid material ground straps to both commercial and military aerospace customers. Our ground straps are exactly designed with appropriate conductive and dissipative materials for each application.

- Ultra-lightweight ground straps with highly conductive or dissipative performance
- Metal-clad microfilament braided solutions
- Significant contribution to weight reduction initiatives in commercial and military aircraft
- Heavy-duty variants for electrical potential grounding from engines, starters, and power units
- Fast turnaround on requests for unusual and build-to-print requirements

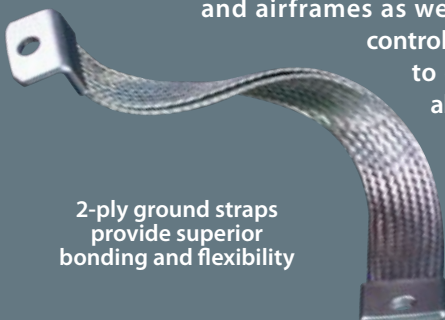

2-ply ground straps
provide superior
bonding and flexibility

High-Performance Ground Straps

Lightweight, general, and heavy-duty



LIGHTWEIGHT ARMORLITE™ MICROFILAMENT GROUND STRAPS

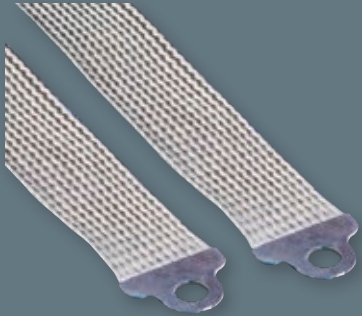

- Ultra lightweight metal-clad stainless steel braid material
- Low-profile lug design and assembly
- Available in seven widths and any length
- Low electrical resistance and high temperature tolerance
- High conductivity-to-weight / material-cross-section ratio
- Corrosion resistant materials for life-of-system durability
- Bend cycle durability up to 250,000 cycles per EN4199-001

LARGE-DIAMETER, LIGHTWEIGHT ARMORLITE™ EWIS GROUNDING HSTS

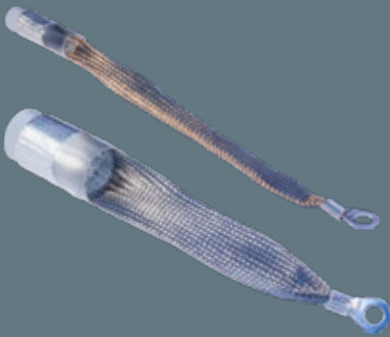

- Oversized heat shrink termination sleeves for grounding of long-run overbraided EWIS harnesses
- Manufactured in-house by Glenair (made in America)
- Fabricated from lightweight, highly flexible ArmorLite™ microfilament EMI/RFI braid material
- Weight reduction up to 70% lighter compared to legacy NiCu A-A-59569 / QQB575 materials

GROUND PLANE ADAPTER PLATE FOR USE WITH COMPOSITE THERMOPLASTIC PANELS



- Resolves connector-to-panel grounding issues in composite fuselage aircraft
- Fabricated from highly conductive tinned beryllium copper IAW AMS 4530 or ASTM B194 and ASTM B545
- Available for all popular aerospace connectors with straight and 90° ground attachments

FAST TURNAROUND ON UNUSUAL/BUILD-TO-PRINT REQUESTS

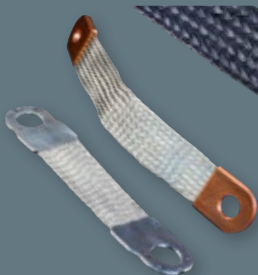

Hybrid braid materials and customizable lug material options

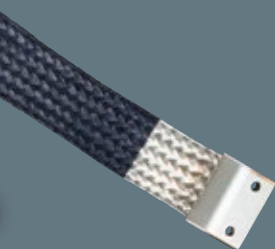

Specialized lug configurations including integrated bonding hardware and angled lugs



Heavy-duty braid and lug configurations



Round cross-section braid



Harsh environment and chemical-resistant ground strap jacketing

Outlook

The Rise of the Machine

I got to listen in on a panel discussion, hosted by a local business school, on the topic of “disruptive innovation.” One of the questions from the floor was about *The Rise of the Machine*—innovations such as eVTOL aircraft (the subject of this issue of *QwikConnect*) that have the potential to radically change our economic landscape.

After some general discussion on the breathtaking pace of innovation—from artificial intelligence to social media—the panel basically concluded that it was critically important for entrepreneurs to stay abreast of technology so as not to be blind-sided by changes that might turn a profitable enterprise into a white elephant.

Interestingly, one of the panelists shared the following story to argue that businesspeople would be far better served to focus on “unchanging human nature” than to become side-tracked by too strong a concentration on technological change.

In 1848, the invention of the automated loom destroyed the ability of hand weavers in the textile industry to earn a living. A family of displaced weavers from Scotland—a father, mother, and two sons aged 13 and 5—were so crushed by their circumstances that they borrowed £20 from a family friend, abandoned their ancestral home, and booked passage on a ship to America.

By the way, as this was a business seminar, the speaker took pause to do a little accounting, noting that upon arrival in America, each family member effectively had a net worth of negative £5.

The family of Scots settled in Pittsburgh, Pennsylvania, where the father—constitutionally unable to find work—handed the role of family breadwinner over to his 13-year-old son who had successfully found employment as a bobbin boy in a mechanized textile mill. Fortunately for the family, the boy was bright, ambitious, and a quick study of the ways of the world. He took bookkeeping courses in the evening and became a voracious reader across many subjects. Ultimately, he started his own business which—to make a long-story short—he sold in 1901, 53 years after landing in America, to J.P. Morgan for \$480 million.

The young man of course was Andrew Carnegie. Asked by a reporter “just what do you know about the making of steel, a commodity that has made you the richest man in the world?” Carnegie replied, “Steam machinery is very complex, and I must confess I don’t understand much of its workings. But what I think I do understand is an even more complex mechanism, and that is the man who operates it.”

The punch line of the story of course, is that Carnegie’s father was destroyed by *The Rise of the Machine* while the son—a businessman with a keen eye for human nature—became the richest man in the world.

Glenair’s unique niche in the interconnect industry is the business of supplying EWIS solutions that meet harsh, mission-critical requirements. From fighter jets to urban air taxis, we have made it our business to solve customer technical problems with the latest, most innovative technologies available. But I would argue that, like Carnegie, it has been our ability to understand human nature—to make fair-dealing and the win-win our company culture—that has always been our best insurance policy against *The Rise of the Machine*.

Chris Toomey

QwikConnect

GLENAIR • Volume 25 • Number 3

Publisher

Christopher J. Toomey

Managing Editor

Marcus Kaufman

Editor/Art Director

Mike Borgsdorf

Graphic Designer

George Ramirez

Technical Consultant

Jim Donaldson

Issue Contributors

Deniz Armani

Will Baxter

Greg Cameron

Tim Hall

Robert Johnson

William Ritner

Troy Sweet

Michael Wofford

Distribution

Terry White

To subscribe or unsubscribe,
please contact Terry White:
twhite@glenair.com

QwikConnect is published quarterly by Glenair, Inc. and printed in the U.S.A. All rights reserved. © Copyright 2021 Glenair, Inc. A complete archive of past issues of QwikConnect is available on the Internet at www.glenair.com/qwikconnect

GLENAIR, INC.

1211 AIR WAY
GLENDALE, CA 91201-2497
TEL: 818-247-6000
FAX: 818-500-9912
E-MAIL: sales@glenair.com
www.glenair.com

