

Qwik Connect

GLENAIR

JANUARY 2013

VOLUME 17

NUMBER 1



INTERCONNECT TECHNOLOGIES FOR

 **CIVIL** 
AVIATION



insulation, open-ended wire splices vulnerable to moisture, non-compliant repairs, deteriorated wiring, corrosion, improper installation, and contamination by metal shavings, dust, and flammable fluids.

As a result of these findings, the Federal Aviation Administration initiated programs to improve safety related to wiring systems, and created training materials to define and describe wiring system design, installation, maintenance and repair.

A “Systems Approach” to Interconnect Cabling

Fixed wing and rotary aircraft manufacturers treat large, interdependent equipment sets as systems: avionics, galleys, cabin lighting, HVAC, IFE, navigation, and so on. But the cables and harnesses that interconnect these equipment sets have always been treated as *a la carte* items with insufficient thought given to best-practice design and performance standards. The FAA, with the support of the principal aircraft manufacturers, has taken steps to change how interconnect technology is specified and managed. The key element of this effort is to begin to treat wiring and associated interconnect components as an important airplane *system* in its own right. The Electrical Wiring Interconnection System (or EWIS, the FAA’s catchy acronym for it) has been defined as: any wire, wiring device, or combination, including termination devices, installed in any area of the airplane to transmit electrical energy between two or more intended termination points.

EWIS was really conceived in 1996, when TWA Flight 800 fell into the Atlantic 12 minutes after its New York departure. During its four-year investigation the NTSB never exactly determined what ignited the 747’s center wing tank, but it did find a number of potentially unsafe conditions nearby, including cracked

EWIS Degradation

Historically, wiring and interconnect components were installed in aircraft in a “fit and forget” manner—without much thought given to aging and degradation. The FAA outlines several variables in EWIS degradation including aging, physical properties, installation and environment, and maintenance, cleaning and repair. Service history shows the manner by which EWIS is installed directly affects degradation: an EWIS not selected or installed properly can accelerate degradation. Good installation and maintenance practices are fundamental for EWIS safety.

Causes of EWIS Degradation

Vibration — High vibration areas tend to accelerate degradation over time, resulting in “chattering” contacts and other intermittent problems. It can also cause tie-wraps to damage insulation, and exacerbate insulation cracking.

Moisture — High moisture areas accelerate corrosion of interconnect components. EWIS installed in clean, dry areas with moderate temperatures hold up well.

Maintenance and repair — Improper maintenance techniques can contribute to EWIS degradation—for example, leaving metal shavings or debris behind after a repair. Wire bundles and connectors should be protected during modification work, and all debris must be cleaned up after work is completed. Generally, EWIS left undisturbed will have less degradation than reworked EWIS. As EWIS become more brittle with age, this effect becomes more pronounced. Repairs that conform to manufacturer’s recommended maintenance practices are generally considered permanent and should not require rework if properly maintained.

Indirect damage — Events such as pneumatic duct ruptures can cause damage that, while not initially evident, can later cause EWIS problems. When such an event has occurred, surrounding EWIS should be carefully inspected to ensure no damage is evident.

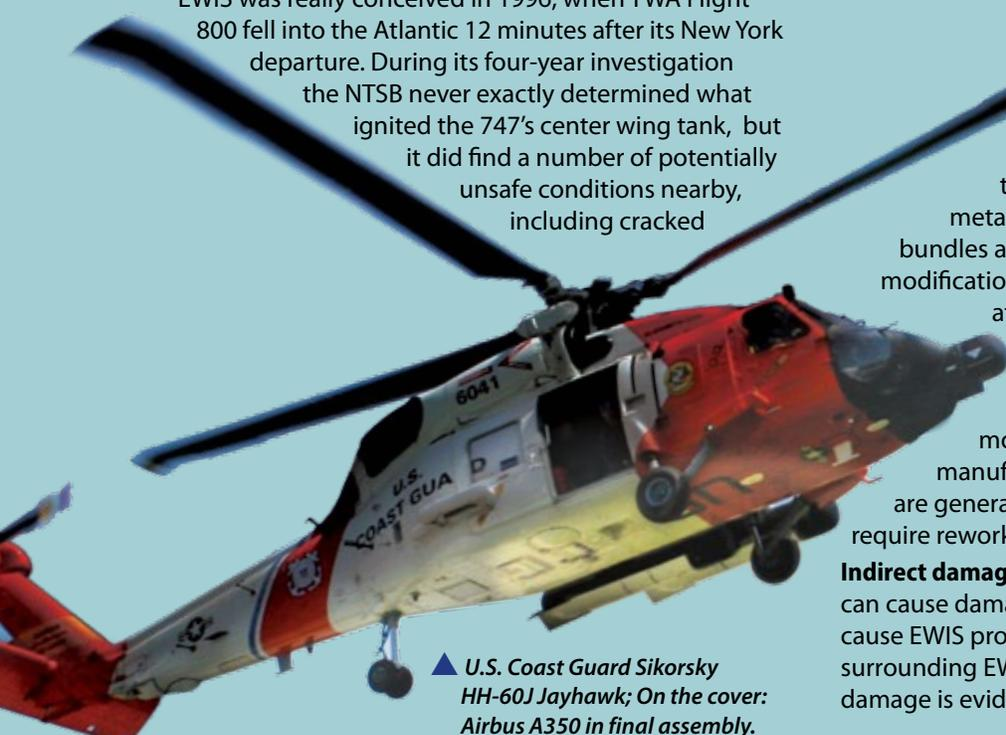

▲ U.S. Coast Guard Sikorsky HH-60J Jayhawk; On the cover: Airbus A350 in final assembly.

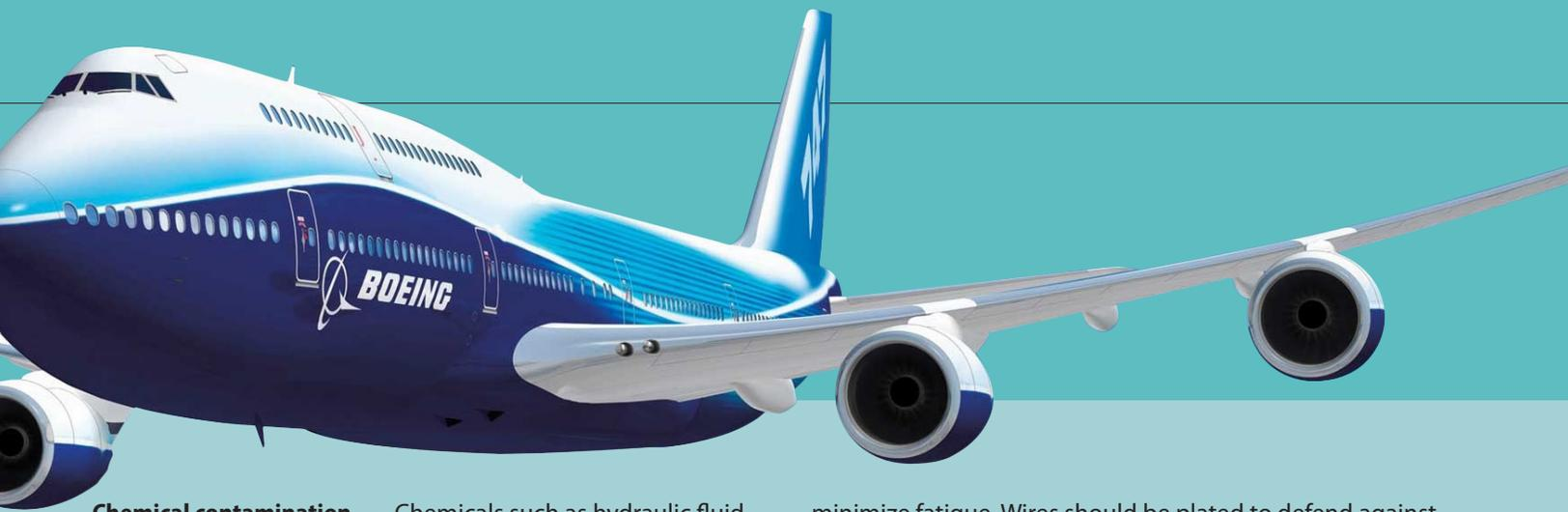

Chemical contamination — Chemicals such as hydraulic fluid, fuel, waste system chemicals, cleaning agents, deicing fluids, and even soft drinks can contribute to EWIS degradation. EWIS in the vicinity of these chemicals should be inspected for damage or degradation. Hydraulic fluids, for example, are very damaging to connector grommet and wire bundle clamps, and can lead to indirect damage such as arcing and chafing. EWIS components potentially exposed to hydraulic fluid should be given special attention during inspections.

Heat — High heat can accelerate degradation, insulation dryness, and cracking. Even low levels of heat can degrade EWIS over long periods of time. This type of degradation can be seen on engines, in galleys, and behind lights.

Improper installation — Improper installation can accelerate degradation. Improper routing, clamping, and terminating during initial installation or during modifications can lead to EWIS damage. FAA policy states that installation and routing instructions should be completely defined in detail to allow repeatability of installation, not leaving installation to the discretion of the installer.

Designing, Installing and Repairing EWIS

Many factors identified by the FAA must be considered when designing, installing or repairing an Electrical Wire Interconnect System:

Electrical Load Determination

System designers must ensure that each aircraft electrical bus can safely support the load based on the electrical capacity of the aircraft's electrical generators and distribution system. All electrical devices must be safely controlled or managed by the aircraft's electrical system, and whenever a device is added, a load analysis should be performed to ensure that the new load on the bus can be powered adequately.

Wire Selection: Size, Plating, and Insulation Materials

Wires should be sized so that they have sufficient mechanical strength, do not exceed allowable voltage drop levels, are protected by circuit protection devices, and meet circuit current-carrying requirements. Small gauge wires should use high-strength alloy conductors and additional support at terminations (grommets, shrink sleeves, etc.) to

minimize fatigue. Wires should be plated to defend against surface oxidation. Elevated temperature degradation of tin- and silver-plated copper conductors will occur if they are exposed to continuous high-temperature operation.

While there is no "perfect" insulation system for aerospace wire and cable, the EWIS designer must consider the best balance of properties (electrical, mechanical, chemical and thermal) for each application.

Determining Current-Carrying Capacity

Ensure the maximum ambient temperature wire bundles will be subjected to, plus the temperature rise due to wire current loads, does not exceed the maximum conductor temperature rating. In smaller harnesses, the allowable percentage of total current may be increased as the harness approaches the single wire configuration. Care should be taken to ensure that the continuous current value chosen for a particular system circuit does not create hot spots within any circuit element which could lead to premature failure.

Wire Substitution for Repairs and Maintenance

EWIS manufacturers are required to perform rigorous qualification testing of wires. The original aircraft manufacturer (OAM) may have special concerns regarding shielding and insulation for certain wiring that performs critical functions, or wiring chosen based on a set of unique circumstances. It is important to review the aircraft maintenance manual or contact the OAM when wire replacement is required.

EWIS Routing

In general, EWIS should be routed and positioned to avoid chafing against aircraft structure or other components, to eliminate or minimize use as a handhold or support, to minimize exposure to damage by maintenance crews or shifting cargo, and to avoid exposure to corrosive fluids. Extra wire length should be supplied to allow for at least two re-terminations.

EWIS components must be protected in wheel wells and other areas where they may be exposed to damage from impact of rocks, ice, mud, etc.

Where practical, EWIS should be routed above fluid lines. Wires and cables routed within 6 inches of any flammable



▲ Aircraft wheel wells are a particularly challenging environment for EWIS routing

liquid, fuel, or oxygen line should be closely clamped and rigidly supported. The compression clamps should be spaced so that if there is a wire break, the broken wire will not contact hydraulic lines, oxygen lines, pneumatic lines, or other equipment whose subsequent failure caused by arcing could cause further damage.

For all types of wire breakouts—“Y,” “T,” and complex multi-branch—there should be sufficient slack in the breakout wires to avoid strain. Care should be taken when plastic tie wraps are used so that the tie wrap head does not cause chafing damage to the wire bundle at the breakout junction.

The EWIS design should preclude wire bundles from contacting the aircraft structure, using stand-offs to maintain clearance. Employing tape or protective tubing as an alternative to stand-offs should be avoided.

Clamping and cable ties

Clamps and cable ties must be constructed of appropriate materials for their installation environment. Clamps must be properly sized for their wire bundles, snug enough to prevent free movement and chafing, and not used where their failure could result in interference with crucial aircraft controls or movable equipment. Clamps must be installed with their

attachment hardware positioned above them so they are unlikely to rotate as the result of wire bundle weight or wire bundle chafing. Wire bundles need to be routed perpendicular to clamps. Appropriate slack needs to be maintained between clamps to protect the wires from stress while keeping the bundle free from contacting the structure. Also, sufficient slack should be left between the last clamp and the termination or electrical equipment to prevent strain at the terminal.

Wire Bend Radii

The minimum radii of bends in wire groups or bundles must not be less than 10 times the outside diameter of the largest wire or cable, except that at the terminal strips where wires break out at terminations or reverse direction in a bundle. The bend radius for delicate thermocouple wire is 20 times the diameter, and for RF cables (e.g. coaxial and triaxial) is no less than 6 times the outside diameter of the cable.

Unused Wires and Excess Wire

Ensure unused wires are individually dead-ended, tied into a bundle, and secured to a permanent structure. Each wire should have strands cut even with the insulation and a pre-insulated closed end connector or a 1-inch piece of insulating tubing placed over the wire with its end folded back and tied.

Coil and stow methods are often used to secure excess length of a wire bundle or to secure unconnected spare bundles. The wire bundle must be secured to prevent excessive movement or contact with other equipment that could damage the EWIS. Coil and stow in medium and high vibration areas requires additional tie straps, sleeving, and support.

EWIS Replacement

The FAA identifies several circumstances in which an EWIS would need to be replaced:

- Wiring has been subjected to chafing or fraying, that has been damaged, or that primary insulation is suspected of being penetrated.
- Wiring on which the outer insulation is brittle or cracked.
- Wiring has been exposed to electrolyte.
- Wiring has visible damage from overheating
- EWIS that bears evidence of having been crushed or severely kinked.
- Shielded EWIS on which the metallic shield is frayed and/or corroded. Cleaning agents or preservatives should not be used to minimize the effects of corrosion or deterioration of wire shields.
- EWIS showing evidence of breaks, cracks, dirt, or moisture in terminal sleeves or splices.
- Sections of wire in which splices occur at less than 10-foot intervals, unless specifically authorized, due to parallel connections, locations, or inaccessibility.

Adding or replacing wires on a bundle

When adding or replacing wires on or in a wire bundle, the replacement or added wire should be routed in the same manner as the other wires in the wire bundle. Wire bundle clamps and/or ties may need to be loosened or removed in order to properly add or replace wires, and should be opened one at a time to avoid excessive disassembly of the wire bundles.

Wire Splicing

Improperly crimped splices can cause increased resistance leading to overheating. Splicing should be kept to a minimum and avoided in high-vibration areas. Splicing of power wires, co-axial cables, multiplex bus, and large gauge wire should be avoided. Self-insulated splice connectors and environmentally-sealed AS7928 conformant splices are preferred. Splices should be located to permit inspection, and splices in bundles should be staggered so as to minimize any increase in the size of the bundle.

Grounding and Bonding

One of the more important factors in the design and maintenance of aircraft electrical systems is proper bonding and grounding—the process of electrically connecting conductive objects to a conductive structure or return path to complete a circuit. Inadequate bonding or grounding can lead to unreliable operation of systems, damage to sensitive electronics, shock hazard, or lightning strike damage. The design of the ground return circuit should be given as much attention as the other leads of a circuit.

Low impedance paths to aircraft structure are normally required for electronic equipment to provide radio frequency return circuits, and for most electrical equipment to facilitate EMI reduction. Components cases producing electromagnetic energy should be grounded to the structure.

All conducting objects on the exterior of the airframe must be bonded through mechanical joints, conductive hinges, or bond straps capable of conducting static charges and lightning strikes.

All isolated conducting parts inside and outside the aircraft, having an area greater than three square inches and a linear dimension over three inches subjected to appreciable electrostatic charging due to precipitation, fluid, or air in motion, should have a mechanically secure electrical connection to the aircraft structure of sufficient conductivity to dissipate possible static charges.

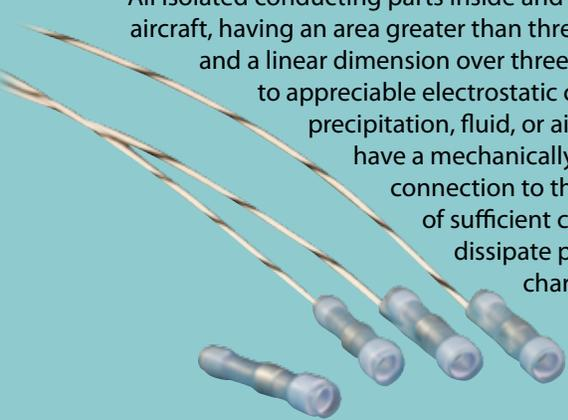

◀ *Glenair HST (Heat Shrink Termination) sleeves and GS81824 qualified in-line splices are designed for fast and easy wire splicing and termination.*



◀ *A Glenair backshell for an aircraft conduit system, showing ink stamping of the part number and CAGE code for easy identification*

EWIS Identification

The proper identification of EWIS components with their circuits and voltages is necessary to provide safe operation and ease of maintenance. Each wire and cable should be marked with a part number and CAGE code so that it can be identified as to its performance capabilities, preventing the inadvertent use of lower performance and unsuitable replacement wire. Unmarked cables are more likely to be reconnected improperly which could cause numerous problems.

Best Practices for EWIS

The number and complexity of EWIS has resulted in an increased use of electrical connectors for flexibility and modular replacement of electronic equipment. The proper choice and application of connectors is a significant part of the aircraft EWIS system. Connectors should be selected and installed to provide maximum safety and reliability to the aircraft.

- The connector used for each application should be selected only after a careful determination of the electrical and environmental requirements. Consider the size, weight, tooling, logistic, maintenance support, and compatibility with standardization programs.
- For ease of assembly and maintenance, connectors using crimped contacts are generally chosen for all applications except those requiring a hermetic seal.
- A replacement connector of the same basic type and design as the connector it replaces should be used.
- Proper insertion and extraction tools should be used to install or remove wires from connectors.
- After the connector is disconnected, inspect it for loose soldered connections to prevent unintentional grounding.
- Connectors susceptible to corrosion may be treated with a chemically inert waterproof jelly, or an environmentally-sealed connector may be used.

- Moisture-proof connectors should be used in all areas of the aircraft, including the cabin. Service history indicates that most connector failures occur due to some form of moisture penetration. Even in the pressurized, environmentally-controlled areas of the cockpit and cabin, moisture can occur due to condensation.
- Consideration should be given to the design of the pin arrangement to avoid situations where pin-to-pin shorts could result in multiple loss of functions and/or power supplies.

Circular Connectors

A wide variety of circular environment-resistant connectors are used in applications where they could be subjected to fluids, vibration, high temperature, mechanical shock, or corrosive elements. Firewall class connectors incorporating these same features prevent fire penetration through the connector opening and continue to function for a specified period of time when exposed to fire. Hermetic connectors provide a pressure seal for maintaining pressurized areas. Glenair now leads the industry in the design and development of high-performance, mission-critical aerospace connectors. From Mil-qualified environmental circular connectors, to glass-sealed hermetic connectors, to EMI/EMP filter connectors, Glenair supplies every power, signal or high-speed cylindrical connector configuration.

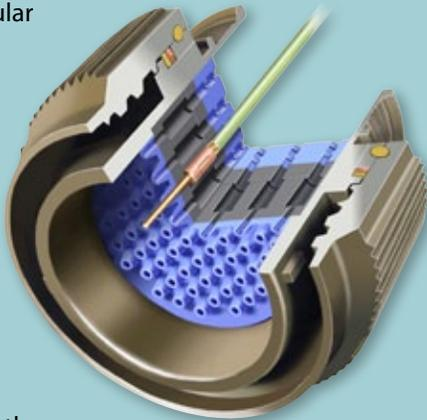

Shield Termination

When EMI/RFI protection is required, special attention should be given to the termination of individual and overall wire and cable shields. Glenair is one of the original interconnect manufacturers specializing in the design and production of cable shield termination backshells, as well as other EMC technologies. We offer both time-tested and innovative solutions—from lightweight and corrosion-free composite thermoplastic backshells with conductive plating and integrated shield socks, to our piggyback boot products that combine environmental sealing and ground shield termination into a single fitting.



Conduit

Conduit systems are ideally suited when wire protection requirements do not allow standard jacketed and shielded cabling to be used. Jet aircraft landing gear applications, for example, require greater flexibility and mechanical protection against impact damage than is possible to provide in even the most aggressively armored cables. Glenair Polymer-Core tubing is lightweight, durable, highly flexible, and available in a broad range of material choices. Metal-core versions offer crush resistance and high-levels of EMI shielding. Connector-to-conduit backshells, transition fittings and special adapters are available in factory assembled and user installable styles. Conduit offers outstanding EMI, mechanical and environmental protection for interconnect wiring including,

- Easy on-site installation and repair
- Superior crush protection and resistance to projectile damage
- Colored conduit for system identification
- Reliable E and H field EMI shielding
- Superior flexibility compared to jacketed cables
- Superior durability and aging protection from heat, chemicals, and fluids.

Glenair is unique in the industry because we produce all our conduit component elements in-house, including extruded polymer tubing, braided EMI shielding, formed metal-core conduit, and machined, die-cast and injection molded backshells, adapters and fittings. In addition, we offer turnkey (wired and un-wired) conduit assemblies.

- Series 72 Annular Polymer-Core conduit is a complete line of economical convoluted tubing backshells and assemblies, ideally suited for general-duty aerospace applications.
- Series 74 Helical Polymer-Core High-Performance convoluted tubing, backshells and assemblies meet requirements for maximum flexibility and performance.
- Series 75 Flexible Metal-Core conduit, fittings and assemblies are designed for optimal mechanical and EMC performance.



Rectangular Connectors

Rectangular connectors are typically used in applications where a large number of circuits are accommodated in a single mated pair. They are available with a wide variety of contacts, including hybrid signal, data, RF, and power types. Coupling is accomplished with integral guide pins that ensure correct alignment, and/or jackscrews that can both align and lock the connectors. Rack and panel versions use integral or rack-mounted pins for alignment and box-mounting hardware for couplings. Glenair manufactures all of the popular industry-standard rectangular connectors used in aviation applications, including, from small to large:

MIL-DTL-83513 QPL and commercial
Micro-D connectors



Our versatile ultraminiature Series 79
Micro-Crimp connector



Our special high-performance versions of the M24308 D-Sub,
the Series 28 HiPer-D



Our revolutionary new modular composite rack-and-panel Series 20
(contact factory for a sneak-peek)

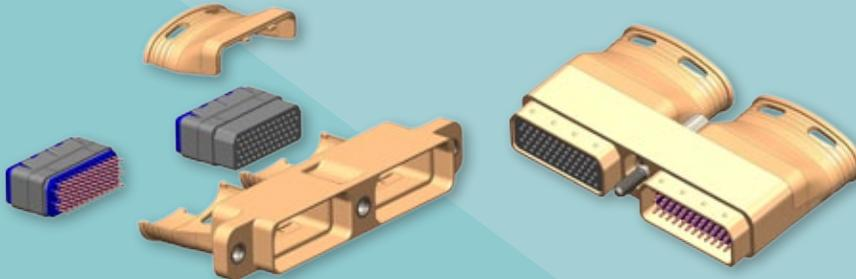

Special-Purpose (filter, hermetic, etc.) ARINC rack-and-panel connectors



Glenair offers a small form factor rectangular connector for virtually every I/O and wire-to-board requirement. All of our rectangular connector products are available with flex-circuit terminations, as well as turnkey point-to-point cordsets.



COMPOSITE THERMOPLASTIC TECHNOLOGY

Composite thermoplastic materials consist of plastic polymer resins combined with glass fibers. The resulting material is extremely lightweight, yet very strong and corrosion-proof. Its unique structure allows the stiffness and strength of composite material to change with the direction of loading. Aircraft and engine OEMs drive the cost and weight-saving requirements which make use of composites attractive. As the technology has improved in recent years, composite use has grown to account for a major portion of the structural weight of many business and commercial aircraft. For example, approximately 50% of the Boeing 787 airframe is made from composite thermoplastics.

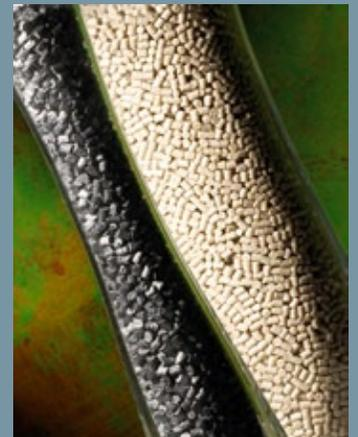

Glass-filled composite thermoplastic resins in pellet form, ready for use in injection molding applications.

ELECTROMAGNETIC In Airframe Systems COMPATIBILITY

Designing for EMC

Designing for optimal Electromagnetic Compatibility (EMC) requires not only the equipment function properly in its intended electromagnetic environment, but the equipment is not an EMI generator affecting its own performance or neighboring data systems and electronics, as follows:

Susceptibility is the tendency of a device to suffer performance degradation when subjected to electrical energy or “noise” within a specific frequency range and amplitude. The opposite of susceptibility is immunity—EMC effectiveness is often defined as the level of immunity from noise.

Emission pertains to the interference potential of a device. One controls emissions to be a good neighbor and avoid degrading performance of other devices in the electromagnetic environment, and to avoid degrading performance of the device itself.

Just as you would always use a surge protector plug strip to power your personal computer, designers must also find ways to protect sensitive data and communications equipment from voltage spikes generated during transient states or static discharges within the overall system.

EMC design can be handled via two basic methods: the crisis approach or the systems approach. In the crisis approach, unwary designers proceed with little regard for

EMC until the device is completed, only to discover that a problem exists when the complete

system is assembled and tested. Solutions introduced at this late stage are usually expensive and consist of add-ons that may enlarge the footprint or weight of the overall system.

The systems approach factors in EMC throughout the design process, treating EMC as an integral part of the mechanical and electrical design.

A common example is noise conducted into a circuit via its power supply. EMC solutions can be placed at

either end of a coupling path, or in between, to make sources less emitting or victims of EMI less susceptible. Although common sense dictates that suppression be placed at or near the source, since one source could affect multiple devices, this approach is not always feasible or even desirable. Some sources, such as radio or radar transmitters and lightning, are inevitable parts of our environment. Devices must function in their presence, so EMC fixes must be applied either on the victim’s side or over the coupling path.



◀ *Glenair EMI filter connector capabilities—from ARINC solutions to D38999 and M24308*

Glenair and EMC

When conditions allow, the best time to design for EMC is before any part of the system is built. This systematic approach has the benefit of eliminating sources of EMI before potential problems arise. This list details the most common techniques and technologies for effecting EMC in interconnect cabling:

- Converting to optical data transmission
- Separation and re-orientation of cable conductors and components
- Effective cable and wire harness design
- Shielding and balancing
- Reflecting the noise signals
- Reducing line-of-sight entry points in equipment and cabling
- Absorbing EMI in permeable material that dissipates it as heat
- Matching impedances among conductors with respect to ground so as to cancel out noise
- Grounding
- Conducting EMI along the “skin” of the device or cable, draining it to ground
- Filtering out EMI at the point of interconnection by using specialized filter connectors
- Introducing voltage suppression diodes to clamp spikes

The reality of interconnect systems design is that it is not always possible to design-in optimal EMC from the beginning. System components from multiple manufacturers are used, new components are added to systems late in development, and unforeseen EMI sources arise. Additionally, most military and other high-reliability interconnection systems are sufficiently complex that EMC cannot be achieved by employing just one of the methods listed above.



▲ *Glenair EMI/RFI cable shield termination solutions*

BE 27-50-92

Weight Reduction ↓

baggage claim tag

In Commercial Aircraft

Miniaturization and Weight Savings

Glenair offers thousands of weight saving connectors, backshells, fiber optic components, conduit assemblies, EMI/RFI braid technologies and junction-box enclosures qualified to existing and new FAA and aircraft OEM specifications.

From our composite and fiber optic products to our industry-standard Series 80 Mighty Mouse, Glenair is ideally positioned to solve aircraft all-up weight (AUW) challenges in such areas as on-board electronics, avionics systems, landing gear harnesses, brake and fly-by-wire systems, and other electrical wire interconnect applications. With weight saving bounties valued at \$1,000 per pound and more, reducing package size and weight of interconnect hardware pays immediate as well as long-term benefits for aircraft owners and operators.



In addition to weight reduction, composite thermoplastic interconnect components offer superior corrosion protection and better resistance to vibration and shock. Glenair uses the most advanced engineering plastics available for our line of composite connectors and accessories. The components undergo rigorous performance testing and are produced IAW AS85049, MIL-DTL-38999 and other standards regulating strength and durability of interconnect systems.

Glenair has become the go-to engineering and design partner for virtually every fixed-wing and rotary aircraft manufacturer in the ongoing work of reducing aircraft weight. Glenair can supply an entire interconnect system—connectors, backshells, junction boxes, conduit systems and fittings, EMI shielding and so on—all from weight saving composite thermoplastic materials. Our composite interconnect products are currently in wide use in military, civil and business aviation. Glenair is also an innovator in fiber optic systems for data-intensive applications as a



▲ A selection of the innovative weight-saving technologies designed by Glenair for use in high-performance airframe applications. These technologies—and the spread of technologies on the following two pages—represent practical and proven approaches to reducing weight while maintaining performance in aerospace applications.

weight saving media replacement for copper and aluminum conductors. For instance, a complete line of lightweight fiber optic Mighty Mouse connectors are now available.

For many airframe system and power plant applications, cable shielding and grounding technologies are the most important elements in controlling EMI and managing electrical safety requirements. Unfortunately, metal shielding and straps—especially when applied in multiple layers—can be extremely heavy. The opportunity to provide robust EMI shielding and grounding at a fraction of the weight is the principal advantage of composite thermoplastic EMI/RFI braid made from AmberStrand® material. Transfer impedance test reports demonstrate the effectiveness of the material compared to conventional metal solutions.

AmberStrand® is the smartest and most cost-effective way to reduce aircraft all-up weights. Replacing standard metal braid with AmberStrand® is like buying dollar bills for 50 cents. 100 feet of 5/8" AmberStrand® vs. tinned copper shield saves over five pounds. Our ArmorLite micro-filament stainless steel braid also saves significant weight compared to standard QQB-A-A-59569 EMI/RFI shielding.

We invite you to select standard catalog products or to leverage our extensive in-house engineering resources to develop targeted solutions which address this most difficult design requirement: enhancing performance while reducing weight.

BE 27-50-92
Weight Reduction ↓
baggage claim tag
In Commercial Aircraft

A selection of
 Glenair's miniaturized
 and weight-saving
 interconnect
 technologies...

**MIL-DTL-38999 Series III Type
 Fiber Optic Connectors and Termini**

The most popular aerospace fiber optic connection system



**MIGHTY
 MOUSE**

*The new industry standard
 for reduced size and weight
 applications*



Series 801
 Double-Start

Series 802
 "AquaMouse"

Series 804
 Push-Pull

Series 805
 Triple-Start

**Series 80 Mighty Mouse
 Special Purpose**

The industry's smallest and lightest multi-function connector series



Quadax
 and Coaxial

Fiber Optic

Power

Series 20 Connectors

COMING SOON...

*High-performance,
 lightweight composite
 miniaturized GPX
 connectors with modular
 inserts and integral
 backshells*

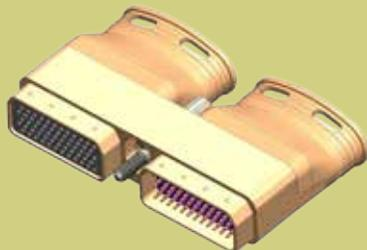

QwikConnect

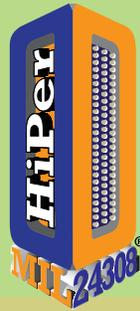

**Series 28 HiPer-D:
 The Advanced Performance
 Intermateable MIL-DTL-24308***

For mission-critical D-Sub applications



**Meets all requirements of MIL-DTL-24308*

Series 79

MICROCRIMP®

*The ultraminiature rectangular Connector with high-performance
 crimp contacts: Power, Signal and Coax*

- Innovative, precision-machined, micro-density, module-to-chassis connector
- Dozens of tooled layouts



Connectors and Cables

*Ultra-miniature rectangular connectors for
 high vibration and shock applications*

- .050 inch Micro layouts deliver optimal connector package density
- Machined shells and TwistPin contacts for reliability and performance



Pressure Boundary Feed-Thrus

*High-performance, weight saving
 composite feed-thrus*



- High-grade engineering thermoplastic
- Six feed-thru layouts with accommodation for 1 – 6 cables
- Jam nut mount with o-ring sealing

AmberStrand®

Ultra-lightweight
conductive composite braid



The smart way to reduce flight weights
in aircraft interconnect and
grounding systems



TurboFlex

Ultra high-flex, lightweight power cable

- Amazingly light and flexible
- 12 AWG – 450 MCM
- Rope lay inner conductor: copper, tin-copper, silver and nickel copper
- Duralectric™ jacket



ARMORLITE™

Microfilament stainless steel braided shielding

Extremely lightweight
and temperature tolerant
conductive EMI shielding
and grounding material



Weight-Saving Composite Backshells



Banding Backshells



Protective Covers



Bulkhead Feed-Thrus



D-Sub and other
Rectangular Backshells



ARINC, Radiall® EPXB and other
Large Form-Factor Backshells

Lightweight, Insulated Braid for Wire and Cable Protection

PTFE-Glass

Polyethelene

Halar

Dacron

Nomex

PEEK

Teflon

Kevlar

Nylon

SWING ARM®

COMPOSITE THREE-IN-ONE BACKSHELL

Save assembly time and weight with the versatile
composite Swing-Arm backshell



Series 72 Annular Polymer-Core Wire Protection Tubing

Quick, lightweight wire protection

- Economical, lightweight and flexible
- Thermally-stabilized Kynar®, PVDF and Siltem



E1 Ochito

Eight size #28 contacts inside a size 8 cavity



- Full 1-G\10-G Ethernet in One Contact
- Drop into MM, 38999, ARINC, etc
- Smallest and Lightest Solution on the Market

BE 27-50-92

High Performance

Interconnect Solutions
In Commercial Aircraft

Glenair's
high-performance
interconnect solutions
for commercial
aircraft

Signal, Data, and Power Contacts



**High Performance
Mighty Mouse and
D38999
RJ45 and USB**

- IP67 sealing in unmated condition
- Crimp and poke termination
- Superior grounding



GLASS-SEALED
Hermetic
CONNECTORS

**High-Temperature,
High-Pressure
Harsh Environment
Glass-Sealed
Connectors**



Series 970 PowerTrip™

The ultimate marriage of "Trip 9" packaging and high-performance power



MIL-DTL-5015

MIL-DTL-38999

MIL-DTL-28840

PowerTrip™

QwikConnect



**In-house multi-pin
planar array
fabrication**

Turnkey EMI/EMP
solutions: from analysis
to delivery, Glenair does it
fast and right

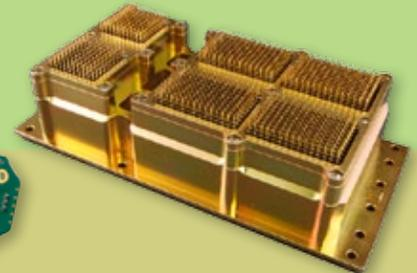

EYE-BEAM

**Expanded Beam
Fiber Optic
Termini**



**Harsh-Environment • Ruggedized
Fiber Optic Media Converters**



Copper-to-Fiber Solutions
for Avionics, In-Flight
Entertainment, and other
Data-Intensive Applications



Compliant

RoHS Compliant Finishes

Glenair offers over a dozen
RoHS-compliant finishes,
including both sacrificial and
barrier seal versions. Electroless
nickel, black zinc nickel, and
nickel PTFE are three of our
most popular solutions for
commercial aerospace.



Electroless Nickel
(Glenair code M, XM)



Series 77 Heat-Shrink Boots and Transitions and Piggyback Boots



Series 74 Helical Polymer-Core Wire Protection Tubing

High-Temperature, High-Performance



- Lightweight and flexible
- Low-smoke, zero halogen PEEK material available
- Harsh chemical environment resistant
- Used in landing gear and aerospace applications

AlphaFlex

Lightweight, Stock Connector-to-Board Flex Terminations



StarShield™

Zero-Length Shield Termination Backshells For Rugged EMI/RFI Applications



HST

Heat Shrink Termination Sleeves

AS83519/1 and /2 type for fast and reliable shield-to-ground termination



CAT-Master

The 10 Gigabit+ Ethernet Connector for Extreme-Performance Cat 5, 6, and 7 Networks



Band-Master™ ATS Advanced Shield Termination System

Reliable EMI shield termination with built-in calibration counter, plus the industry's widest range of band widths and lengths.



MIL-DTL-38999 Type Special-Purpose Connectors





FLY-BY-WIRE

Fly-by-wire (FBW) systems replace conventional manual flight controls of an

aircraft with an electronic interface. Though quite complex, FBW system operation can be explained in fairly simple terms: when a pilot moves the control column (or “sidestick”), a signal is sent to a computer to perform a calculation of the voltages and the number of signals. The computer then signals a surface actuator, and the surface begins to move. Sensors in the actuator report their position back to the computer, and when the actuator reaches the desired position, the incoming and outgoing signals complete the feedback loop and the actuator stops moving.

Fly-by-wire control systems also allow aircraft computers to perform tasks without pilot input. Automatic stability systems employ gyroscopes fitted with sensors to determine changes in pitch, roll and yaw axes. Any movement from straight and level flight results in signals to the computer, which automatically moves control actuators to stabilize the aircraft.

A FBW aircraft is typically lighter than a similar design with conventional controls. In part, this weight reduction is due to the lower overall weight of the system components and smaller structural stability surfaces.

Fly-by-optics is sometimes used instead of fly-by-wire because fiber optic transmission can transfer data at higher speeds and it is immune to electromagnetic interference. In most cases, the cables are just changed from electrical to optical fiber cables. This FBW variant is sometimes referred to as “fly-by-light.”

And for the future, how about “fly-by-wireless”? Wiring adds considerable weight to an aircraft, so researchers are exploring wireless control solutions. In addition to reducing weight, a wireless solution has the potential to reduce costs throughout an aircraft’s life cycle. For example, many key failure points associated with wire and connectors will be eliminated thus hours spent troubleshooting wires and connectors will be reduced. Additionally, engineering costs could decrease because less time would be spent on designing wiring installations and late changes in aircraft design would be easier to manage.

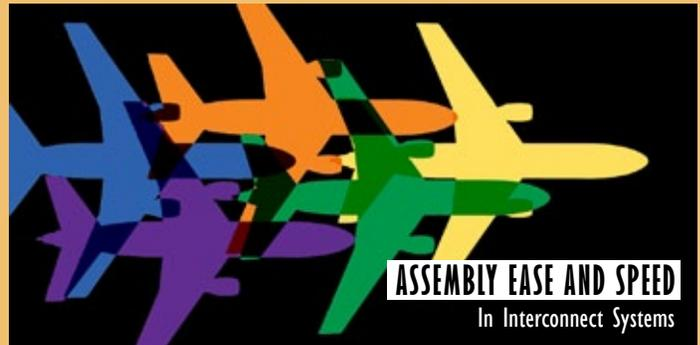

Time and Labor Saving Interconnect Technologies

Assembly of interconnect systems in commercial aircraft is a complex undertaking. Technicians often need to repeat a task dozens of times—for example, the accurate positioning of heat-shrink termination sleeves on wires, or the recovery of heat-shrinkable boots onto cables. Connector designs which incorporate backshell functionality, such as shield/band termination or strain relief can not only reduce part numbers and inventory, but can accelerate and simplify assembly.



▲ *Labor-saving connector with integrated backshell*

Glenair offers dozens of innovative products designed to improve speed of assembly in aircraft interconnect systems. Some examples include Glenair Band-in-a-Can backshells, which combine the efficiency and convenience of band style shield termination with a backshell to protect the shield termination area from damage due to rough handling and provide for robust cable strain-relief.



▲ *Labor-saving Swing-Arm backshell with integrated shield sock*

Glenair’s patented composite Swing-Arm strain relief backshell provides lightweight and corrosion free termination of EMI/RFI cable shielding. This one-of-a-kind backshell has quickly become a standard in commercial aircraft applications. Made from high-temperature composite thermoplastic, these rugged assemblies offer easy installation and outstanding weight and cost reduction. Swing Arm saves money by reducing unnecessary inventory of straight 45° and 90° backshells with a single 3-in-1 design.

Performance tested to stringent AS85049 mechanical and electrical standards, Swing Arm is available with a self-locking coupling nut with and without an integrated braid-sock.

These innovative backshells are joined by Glenair’s newest labor-saving devices—Heat Shrink Termination sleeves, Mil-qualified in-line splices, and composite Piggyback boot adapters with integrated shield socks—detailed on the following pages.

Labor-Saving Interconnect Technologies From Glenair Engineering

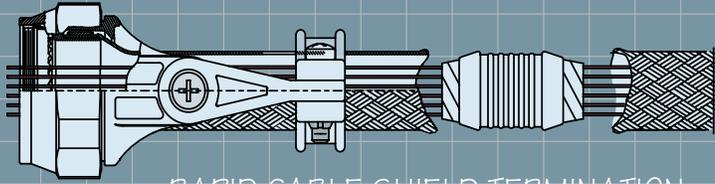

RAPID CABLE SHIELD TERMINATION WITH SHIELD-SOCK BACKSHELL AND SPLIT SUPPORT RING

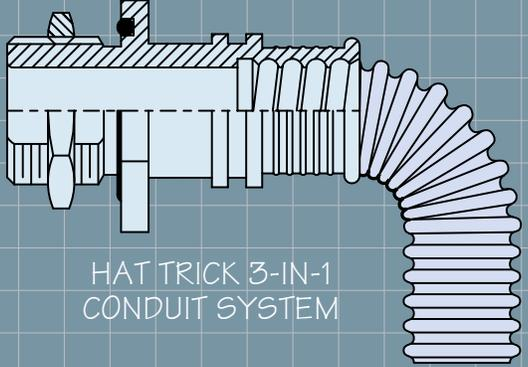

HAT TRICK 3-IN-1 CONDUIT SYSTEM

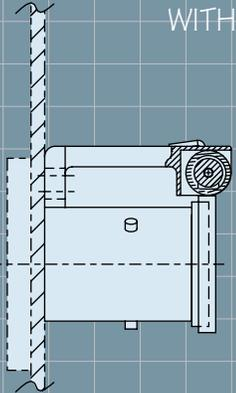

SPRING-LOADED "FLOP-LID" PROTECTIVE COVER

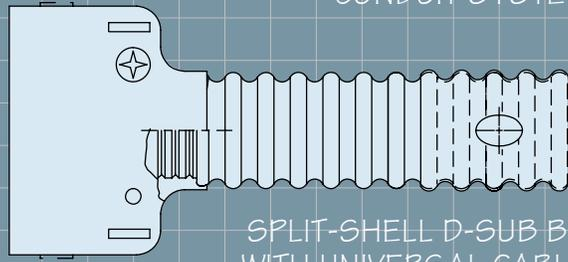

SPLIT-SHELL D-SUB BACKSHELL WITH UNIVERSAL CABLE ROUTING

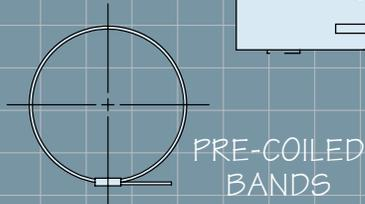

PRE-COILED BANDS

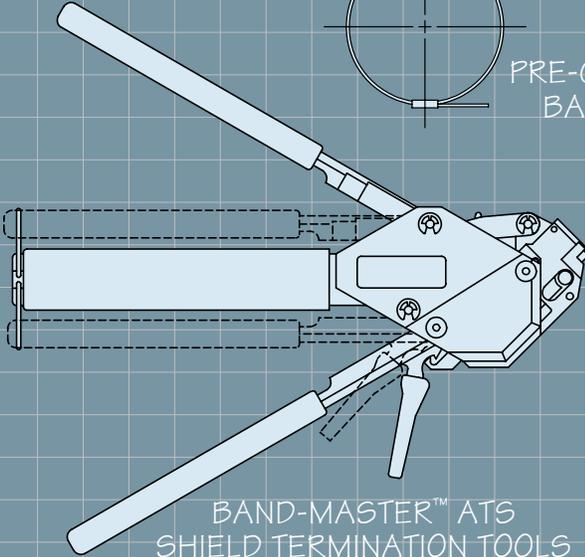

BAND-MASTER™ ATS SHIELD TERMINATION TOOLS WITH BUILT-IN CALIBRATION COUNTER

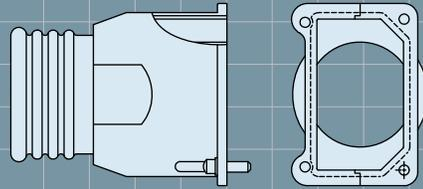

SPLIT-SHELL BACKSHELLS AND FEED-THRUS (MIL-C-81659 SHOWN)

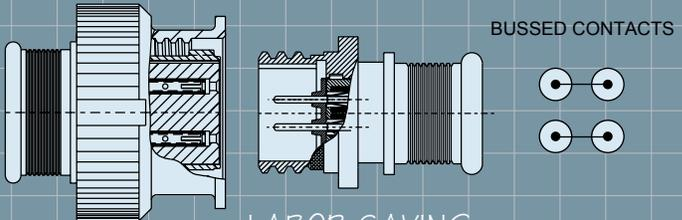

LABOR-SAVING CANBUS CONNECTORS

BUSSED CONTACTS

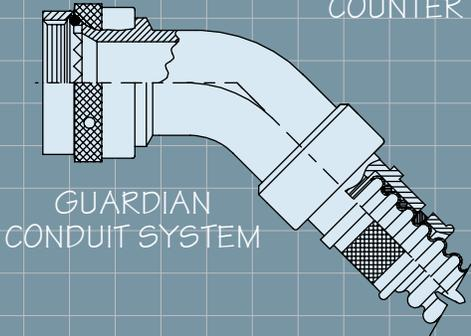
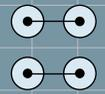

GUARDIAN CONDUIT SYSTEM

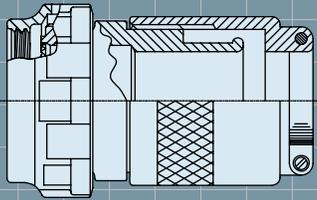

DUAL-FUNCTION "BAND-IN-A-CAN" EMI/RFI BACKSHELL AND STRAIN RELIEF



The recovery of 3-to-1 and 4-to-1 ratio shrink boots for environmental sealing and strain relief on aircraft interconnect cabling is a critical final step in the cable harness assembly process. This time-consuming task relies on each individual technician to correctly position and shrink boots on each of the many connectors found on the aircraft. Glenair composite piggyback shrink boot connector adapters take all of the

guesswork out of this time-consuming assembly task. Partially recovered boots, pre-attached to composite adapters, take less than half the time to shrink in place, and are exactly pre-positioned for optimal sealing and strain relief each and every time the task is completed.

Time and Labor Saving Piggyback Shrink Boot Connector Adapters



310-048 Environmental Piggyback Boot Adapter

Pre-positioned and partially recovered shrink-boot/adaptor unit is ready for fast and reliable final recovery of the boot. Provides durable environmental sealing and strain-relief to the cable-to-backshell junction. Adapter is lightweight composite thermoplastic.

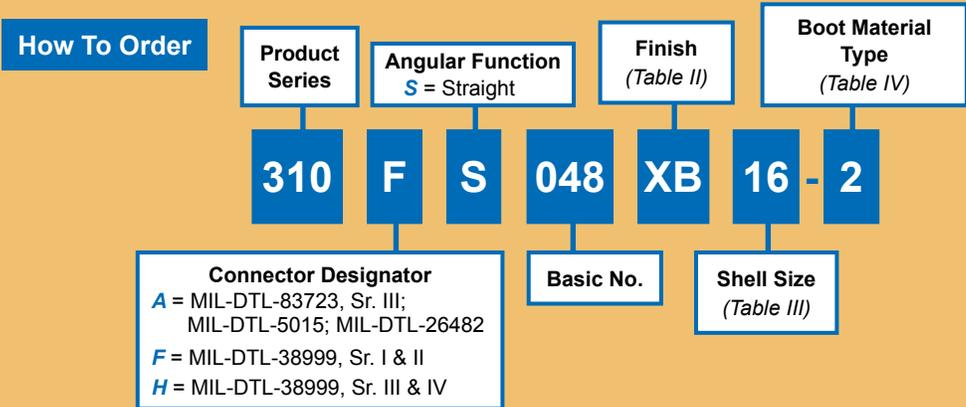

317-102 EMI/RFI Environmental Piggyback Boot Adapter with Drop-In Banding Porch



This Piggyback boot features a unique drop-in conductive banding porch. The pre-positioned and partially recovered shrink boot is ready for final recovery after the cable shield is band terminated to the drop-in accessory. Adapter is lightweight composite thermoplastic.

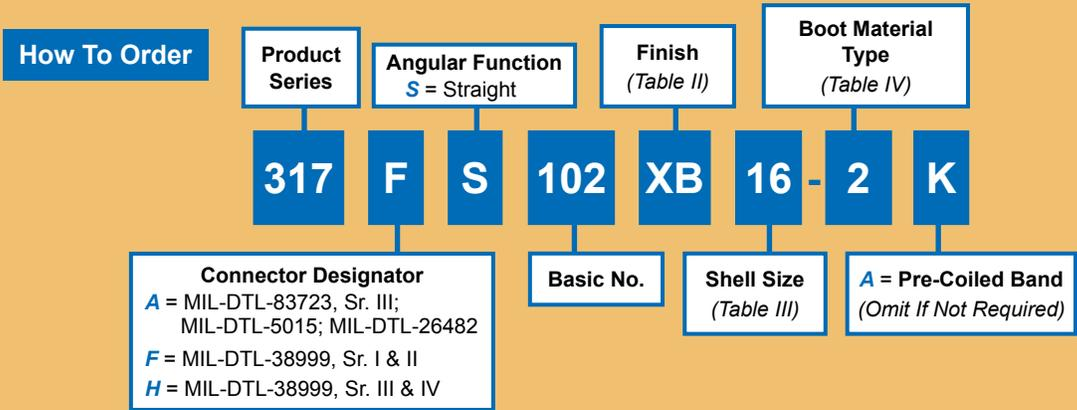

319-183 EMI/RFI Environmental Piggyback Boot Adapter with Integrated Shield Sock



This integrated EMI/RFI shield sock, with its partially recovered shrink-boot and composite connector backshell delivers speed, convenience, and performance. Simply couple in place, terminate the supplied shield to the cable and complete the recovery of the boot.

How To Order



Connector Designator
A = MIL-DTL-83723, Series III; MIL-DTL-5015; MIL-DTL-26482
F = MIL-DTL-38999, Series I & II
G = MIL-DTL-28840
H = MIL-DTL-38999, Series III & IV
U = MIL-DTL-29600

Basic No.
Shell Size
(Table III)
Boot Material Type
(Table IV)



443-033 EMI/RFI Environmental Band-in-a-Can Piggyback Boot and Composite Backshell

This composite, two-piece band-in-a-can adapter comes equipped with a partially recovered shrink boot attached to the nut. After the cable shield is terminated to the band porch, simply screw the nut and boot into place and complete the boot recovery process.

How To Order

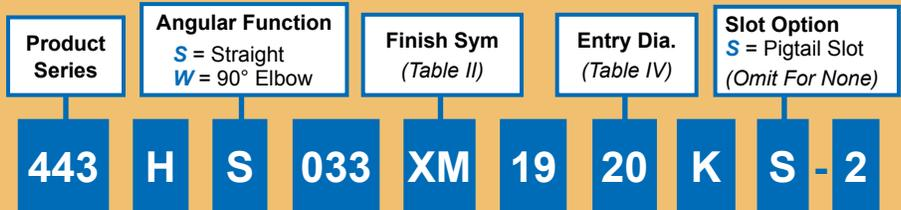

Connector Designator
A = MIL-DTL-83723, Series III; MIL-DTL-5015; MIL-DTL-26482
F = MIL-DTL-38999, Series I & II
G = MIL-DTL-28840
H = MIL-DTL-38999, Series III & IV

Basic No.
Shell Size
(Table III)
Band Option
K = Precoiled
(Omit For None)
Boot Material Type
(Table V)

635-005 Environmental Piggyback Boot Cable Feed-Through

This composite feed-through is supplied with a pre-positioned and partially recovered shrink-boot—ready for fast and reliable final recovery of the boot. Provides durable environmental sealing and strain-relief to the feed-through-to-box junction. Adapter is lightweight composite thermoplastic.



How To Order

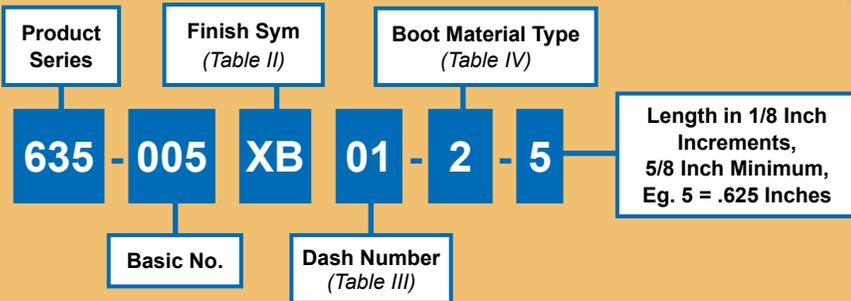

HIGH SPEED DATA

transmission support



▲ *Glenair high-speed connectors with fiber optic termini and/or size #8 shielded Quadrax contacts*

Fundamentally High-Speed

The goal of any high-speed data communication network is to maximize data throughput with available bandwidth. Traditional approaches include fiber optics as well as Coax, Twinax, and Quadrax-equipped electrical connectors. Recently, Glenair has invented additional connector designs that do not rely on shielded

contacts for high-speed performance and offer faster and easier crimp contact termination as well as package miniaturization and reduced weight. In optimizing these lighter-weight products, we focused on four overlapping and inter-related factors:

Protocol: A high-speed protocol is used to optimize the amount of data per bandwidth transferred. Examples could be 100BASE-T for computer networking, or a Military/Aerospace protocol like MIL-STD-1553.

Distance: How far does the data have to travel? A data system to connect a monitor to a computer might only have to travel one or two feet, but a fiber optic trunk line could have end points thousands of miles apart.

Hardware Cost/Availability: What cabling, routing, and devices are most cost-effective? Should the system be designed for flexibility or is it a more stable, permanent platform? Will the system be expected to function in harsh environments?

Data Rate: Systems characterized as “high-speed” range from CAN bus/ARINC 825 data protocols that transmit at less than 1 MHz bandwidth, to DisplayPort protocols that can transmit in a range of 5-17 Gigabits per second. The speed of data is another important consideration.

High speed interconnect engineers make design decisions based on the interplay of all these factors. For example, for a networking system that uses the 100BASE-T protocol, data rates can go up to 20 MHz, so appropriate cabling and hardware that accommodates distance limitations is required.

The Ideal Connector in a high speed system should be perfectly matched to the cable impedance. Glenair engineers take into account the changes that occur in high-speed

electrical transmission (skin effect, shorter wavelengths) and match the transmitting wire’s materials and spacing as closely as possible for the best high speed connector performance.

The matrix table at right is a handy reference to determine which high-performance Glenair connector series is best suited for which high speed application.

Series 80 Mighty Mouse Ultraminiature Connectors and Cables



Glenair’s revolutionary connector series reduces interconnect system size and weight by 50% compared to MIL-DTL-38999 connectors. Equipped with controlled impedance or standard signal contacts, the Mighty Mouse is ideal for Mil-Aero data bus protocols like CAN bus and 1553, as well as Ethernet and networking protocols (10BASE-T to 1000BASE-T).



Series 80 Mighty Mouse High Speed PFA Teflon® Insert Connectors

The Mighty Mouse product line now includes a broad range of insert arrangements equipped with special PFA insulators for 100 Ohm high speed peripheral and display protocols such as eSATA, USB 3.0, and HDMI. High-speed cordsets, terminated to a broad range of commercial USB and Ethernet interconnects are also available as standard catalog offerings.

Series 811 Mighty Mouse High Density Connectors



Glenair Series 811 Mighty Mouse High Density (HD) offers weight-saving, high-reliability performance in eSATA, USB 3.0, and HDMI protocol applications. Mighty Mouse HD utilizes high performance micro TwistPin contacts set on 0.050 inch centers for optimal contact layout density. Five insert arrangements are available from 7 to 42 contacts.

Series 79 Micro-Crimp Rectangular Connectors

For high-bandwidth 1000BASE-T Ethernet networking protocols that require advanced levels of environmental protection, electromagnetic shielding and size/weight reduction, Glenair offers the Series 79 Micro-Crimp. The Micro-Crimp connector features crimp, rear-release size #23 contacts on 0.075 inch (1.9 mm) spacing, as well as size #12 and #16 power and coaxial crimp contacts in a range of hybrid layouts. Panel mounted connectors feature conductive sealing gaskets. Right angle printed circuit board connectors have an EMI shroud to prevent electromagnetic interference.



Glenair Connectors Suitable for Use in High-Speed Applications

High-Speed Protocol

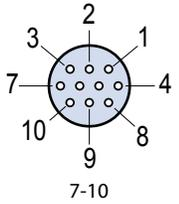
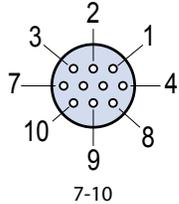
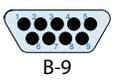
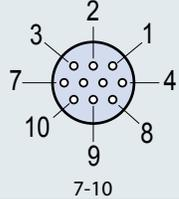
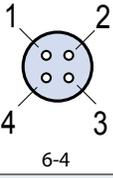
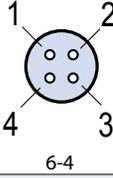
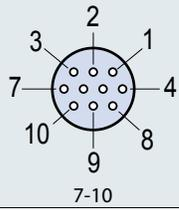
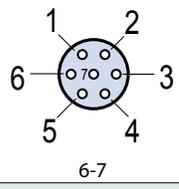
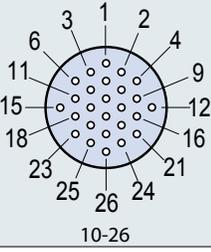
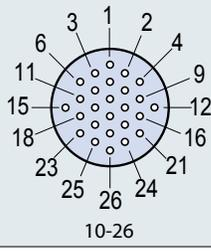
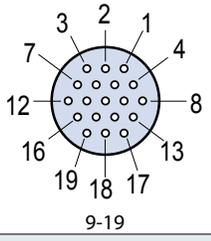
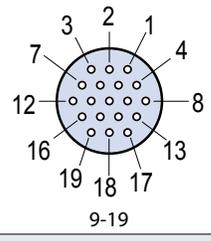
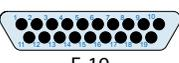
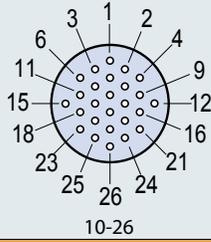
	Series 80 Mighty Mouse	Series 80 Mighty Mouse High Speed	Series 811 Mighty Mouse High Density	Series 79 MicroCrimp
Up to: Cat 5e (1000BASE-T)	 7-10	 7-10	 6-12	 B-9
Up To: Cat 6A (10GBASE-T)	Not suitable	 7-10	 6-12	Not suitable
USB 2.0	 6-4	 6-4	 5-7	 A-5
USB 3.0	Not suitable	 7-10	Not suitable	Not suitable
eSATA/SATA	Not suitable	 6-7	 5-7	Not suitable
DVI-D	 10-26	 10-26	 8-30	 G-33
HDMI	 9-19	 9-19	 7-22	 E-19
Display Port	Not suitable	 10-26	 7-22	Not suitable

2570-1269

ARINC 828 MIL-DTL-38999 Series III Type Quadrax Plug/Receptacle for EFB Standard

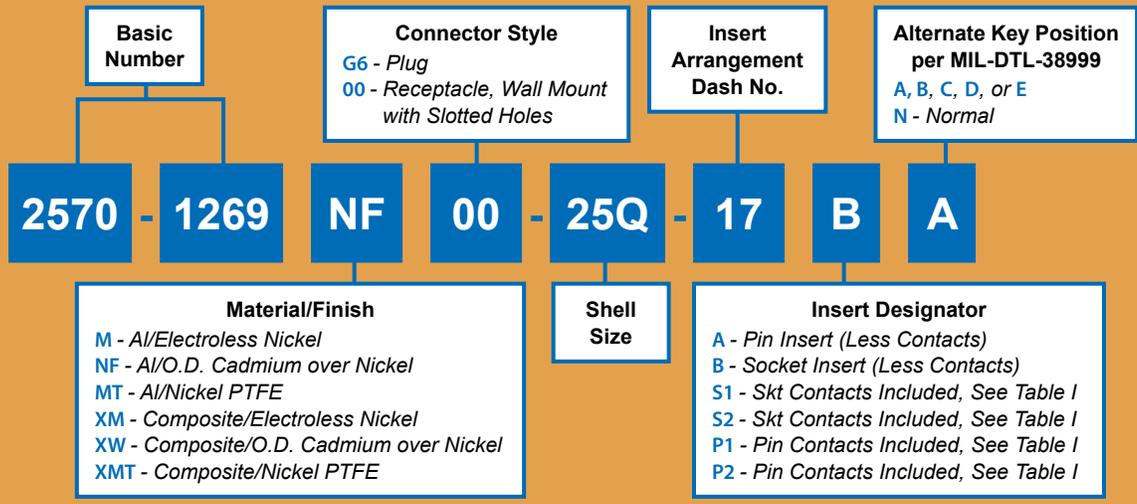
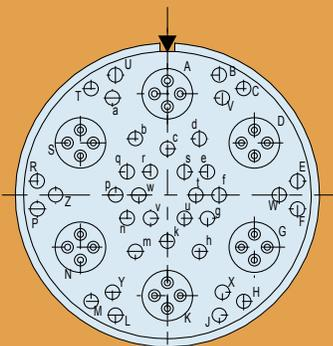
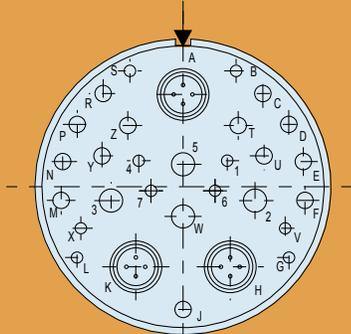

FIGURE 1: INSERT ARRANGEMENTS



Arrangement 25Q-17
36 #22 Contacts
6 #8 Quadrax Contacts (J1)



Arrangement 25Q-20 (IAW prEN 3645-001)
10 #20 Contacts
13 #16 Contacts
4 #12 Contacts
3 #8 Quadrax Contacts (J2, J3, J4)

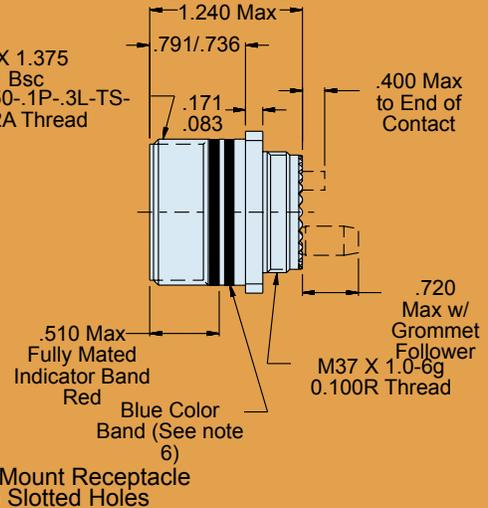
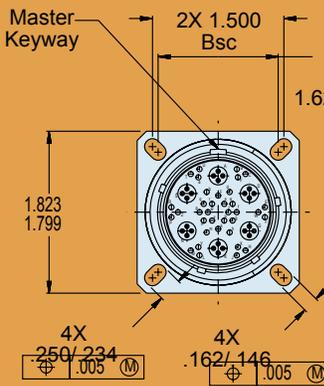
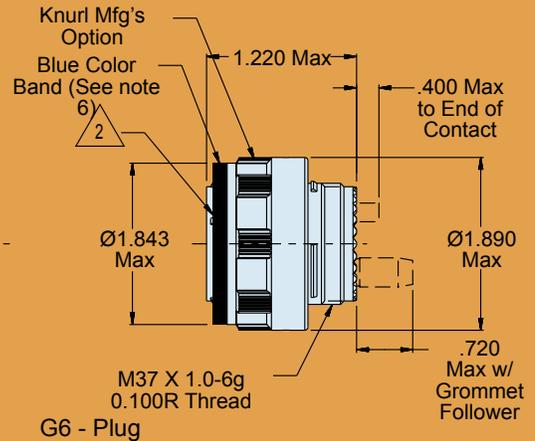
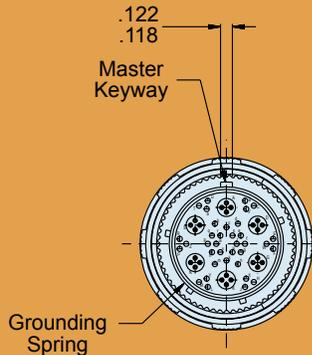

00-Wall Mount Receptacle With Slotted Holes

Table I: Cross-Reference to ARINC 828 Connectors (Wall Mount Receptacle)

ARINC 828 (Receptacle)	Glenair Conn P/N (See Notes 3 and 4)	Quadrax Contact Socket P/N	Qty	Reference Cable Accommodated
J1	2570-1269M00-25Q-20BA	Not Supplied (To Be Ordered Separately. See Note 5)		
	2570-1269M00-25Q-20S1A	854-002-02F	3	PIC E51424;TENSOLITE NF24Q100; BMS 13-72T03C04G024*; ECS 422404*
	2570-1269M00-25Q-20S2A	854-002-04F	3	PIC E50424*; ABS 1503KD24*
J2	2570-1269M00-25Q-17BA	Not Supplied (To Be Ordered Separately. See Note 5)		
	2570-1269M00-25Q-17S1A	854-002-02F	6	PIC E51424;TENSOLITE NF24Q100; BMS 13-72T03C04G024*; ECS 422404*
	2570-1269M00-25Q-17S2A	854-002-04F	6	PIC E50424*; ABS 1503KD24*
J3	2570-1269M00-25Q-17BB	Not Supplied (To Be Ordered Separately. See Note 5)		
	2570-1269M00-25Q-17S1B	854-002-02F	6	PIC E51424;TENSOLITE NF24Q100; BMS 13-72T03C04G024*; ECS 422404*
	2570-1269M00-25Q-17S2B	854-002-04F	6	PIC E50424*; ABS 1503KD24*
J4	2570-1269M00-25Q-17BC	Not Supplied (To Be Ordered Separately. See Note 5)		
	2570-1269M00-25Q-17S1C	854-002-02F	6	PIC E51424;TENSOLITE NF24Q100; BMS 13-72T03C04G024*; ECS 422404*
	2570-1269M00-25Q-17S2C	854-002-04F	6	PIC E50424*; ABS 1503KD24*

Table II: Quadrax Contact Pin P/N for Plug Connector

	Quadrax Contact Pin P/N	Reference Cable Accommodated
P1	854-001-02F	PIC E51424;TENSOLITE NF24Q100; BMS 13-72T03C04G024*; ECS 422404*
P2	854-001-04F	PIC E50424*; ABS 1503KD24*

Recommended Panel Mounting Holes (Receptacle)

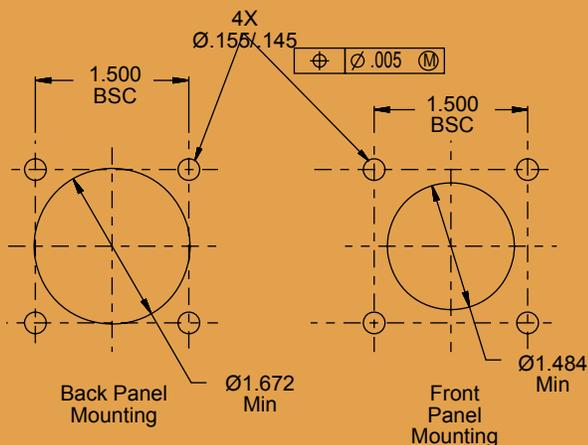

Table III: Signal/Power Contact P/N (to be supplied w/ "P" or "S")

Pin/Socket	Contact Size	Contact P/N
Pin	22	M39029/58-360
	20	M39029/58-363
	16	M39029/58-364
	12	M39029/58-365
Socket	22	M39029/56-348
	20	M39029/56-351
	16	M39029/56-352
	12	M39029/56-353

APPLICATION NOTES

- Material/Finishes:
 Receptacle, Barrel, Coupling Nut - See P/N Development
 Insulators - High Grade Rigid Dielectric
 Seals - Fluorosilicone
 Grounding Spring - BeCu Alloy
 Quadrax Contacts -
 Pin - See 854-001-XX (XX Denotes Cable Type, See Table II)
 Socket - See 854-002-XX (XX Denotes Cable Type, See Table I)
 Grommet Follower - 687-754-8-X
 Signal/Power Contacts - When insert designator is P* or S*, the Signal/Power contacts in Table III will be shipped with connector, as required, along with Quadrax contacts.
- Insert arrangement is in accordance with MIL-STD-1560 and Figure 1
- Common EFB connector material/finish IAW ARINC 828 is Al/ Electroless Nickel, code "M". Other material/finishes are also available, see P/N development for ordering.
- All "J*" connectors, as defined in ARINC 828, are receptacles and their contacts are sockets. The mating plug connectors with pin contacts are not defined in the standard, and can be ordered as shown in P/N development.
- Glenair connector is designed to accept Glenair Quadrax contacts only.
- Blue color band indicates rear release system.

SONGWRITERS TAKE

Songwriters have long turned to aviation and romance of flight. From classic compositions to modern works like Willie Nelson's   have reveled in the wonder of flight. You may

version of



or Sinatra

world over enjoyed Disney's



an



from

every generation grooved to



Rolling Stones



&



. But here

Curtis Mayfield's



. We

FLIGHT



... for its soaring images and the excitement

... tions like



THE



, to more



THE



-S, musicians

... y have grown up listening to Nat King Cole's

... t's



me



the



. Youngsters the



from the film Mary Poppins and

... n the animated classic, Dumbo. Rockers in

Steve Miller's



an



and the

... at Glenair we have our own favorite,

... e hope it's one of yours too.



FUN (AND FREAKY) FLIGHT FACTS

There has been over a five-fold increase in the number of birds hitting airplanes over the last two decades!

A bird strike —also called a bird hit or BASH (for Bird Aircraft Strike Hazard)—is a collision between a bird and an airplane. 65% cause little damage to the aircraft, but bird strikes have caused a number of accidents with human casualties. Jet engines can handle a collision with a bird up to about 4 pounds, anything larger can be catastrophic (collisions are usually fatal for the bird.) Over the past two decades, bird strikes have increased from nearly 1,800 a year to more than 9,600.



In a CBS news interview, bird strike expert Captain Chelsey “Sully” Sullenberger (who landed his US Airways Airbus 320 on the Hudson River after birds knocked out both engines in 2009), blamed the increase on higher bird populations and more airplane flights. He also suggested that smarter land use near airports (e.g., not placing a bird-attracting garbage dump next to a runway) could be an effective prevention.



You can't really get stuck on an airplane's toilet

In a 2002 BBC report, a woman claimed that she hit the flush button while still seated on the airplane toilet, and was sealed to the seat so tightly that airport technicians had to free her. A subsequent investigation revealed that the incident never actually happened.

Airplane toilets do use a vacuum flush system, because carrying enough liquid for a flight's worth of flushes would be too much of a weight increase. The flush button is usually placed behind the lid so that it's impossible to flush while still seated.... just to be safe.

You might feel drunker in the air than on the ground...

...but you're really not. Your blood alcohol level doesn't actually change when drinking on a plane, but you might *feel* drunker due to lower quantities of oxygen and the airplane's pressurized cabin. However, drinking to excess is definitely not recommended—nausea at 25,000 feet, especially when combined with turbulence, is no fun for anyone.



Contrary to popular belief, you aren't any safer sitting near the wing

Except during a fire, in which case the wing seat emergency exit would allow you faster egress from the aircraft. *Popular Mechanics* reviewed data of every commercial crash between 1971 and 2005 and discovered that those sitting in the *tail* had a 40% higher chance of survival.



Flying really is safer than driving

A study by the University of Michigan Transportation Research Institute found that driving the equivalent distance of a flight poses a 65 times higher injury risk than flying in a commercial airplane. A recent Wall Street Journal article reported the number of fatal crashes worldwide at 22 for 2012, down from 28 in 2011. Airline safety has improved steadily over the years with more reliable equipment, better training, and advances in air traffic control. The statistics are reassuring: The risk of being killed in a plane crash in any particular year is one in 125 million, twelve times safer than travelling by car. In fact, you're more likely to have a fatal accident during six hours at work than during six hours on an airplane!



You're not any more likely to catch the flu on an airplane

The air in an airplane is often safer than air on the ground! Modern aircraft use sophisticated HEPA filtering systems which remove 99.5% of all germs and viruses, even SARS and bird flu. Sitting next to a sick person on a plane might make you more likely to catch their bug, but that's true on the ground, too.



Contrails are water vapor, Chemtrails are conspiracy-theorist fodder

The pretty white trails that airplanes leave behind are called contrails (short for condensation trails). Airplane fuel produces carbon dioxide and water when burned, and the trails are mostly water vapor that freezes and crystallizes at high altitude. If you look closely, there's always a gap between the jet engine and the beginning of the contrail, because it takes a bit of time for the water vapor to freeze.

The Chemtrail conspiracy holds that contrails are actually harmful chemical and biological agents deliberately sprayed at high altitudes by the government or military for clandestine purposes. Official agencies have received thousands of demands for explanation, but the existence of chemtrails has been repeatedly denied by scientists worldwide. The U.S. Air Force stated that the chemtrail theory is a hoax which "has been investigated and refuted by many established and accredited universities, scientific organizations, and major media publications."

Black Box flight data recorders are actually orange

Flight data recorders are used to record instructions and communications on aircraft. They assist in accident investigation, analyzing air safety issues, material degradation and engine performance. They are engineered to withstand the force of a high-speed impact and the heat of an intense fire. Popularly referred to as a "black box," they are actually coated with a heat-resistant bright orange paint for visibility in wreckage.



Commercial airliners do have an autopilot

Pilots typically engage the autopilot function sometime during mid-flight. They are often used throughout most of a flight, but are rarely used during takeoff and landing. A plane operated on autopilot can make more precise adjustments than a human pilot and can be more fuel efficient, except in turbulence. So sit back, relax, and enjoy the flight.

Glenair Interconnect Technology Application in Commercial Aircraft

As a valued design partner to the commercial aircraft industry, Glenair interconnect innovations are found virtually everywhere on modern airplanes—from severe environment landing gear conduit assemblies in the wheel well, to electrical-optical media converters for in-flight entertainment systems.

Avionics, Flight Management and Data Networks

- ARINC Connectors and Backshells
- Databus Interconnects/Backshells
- D-Sub Connectors
- High-Speed Connectors
- ARINC & D38999 Type Fiber Optic Assemblies
- EMI/EMP Filter Connectors
- Flex Circuitry
- Micro-Crimp Rectangular Connectors and Backshells
- ARINC 828 Connectors
- High-Frequency Contacts
- Quadrax High Speed Contacts
- Superseal® Ruggedized RJ45 & USB Connectors
- Pneumatic Contacts
- Series 80 Mighty Mouse High Speed Connectors

Radar, Detection, and Communication Systems

- Filter and TVS Connectors
- Hermetic Connectors
- EMI/RFI Braided Shielding
- StarShield Zero-Length Shield Termination Backshells
- Coaxial Contacts
- High-Speed Connectors
- Micro-D and Series 79 Micro-Crimp Connectors

Landing Gear

- Conduit and Turnkey Conduit Assemblies
- Filter Connectors
- MIL-C-26482 Type Connectors
- MIL-C-83723 Series III Type Connectors
- MIL-C-26500 Type Connectors
- MIL-DTL-38999 Type Connectors

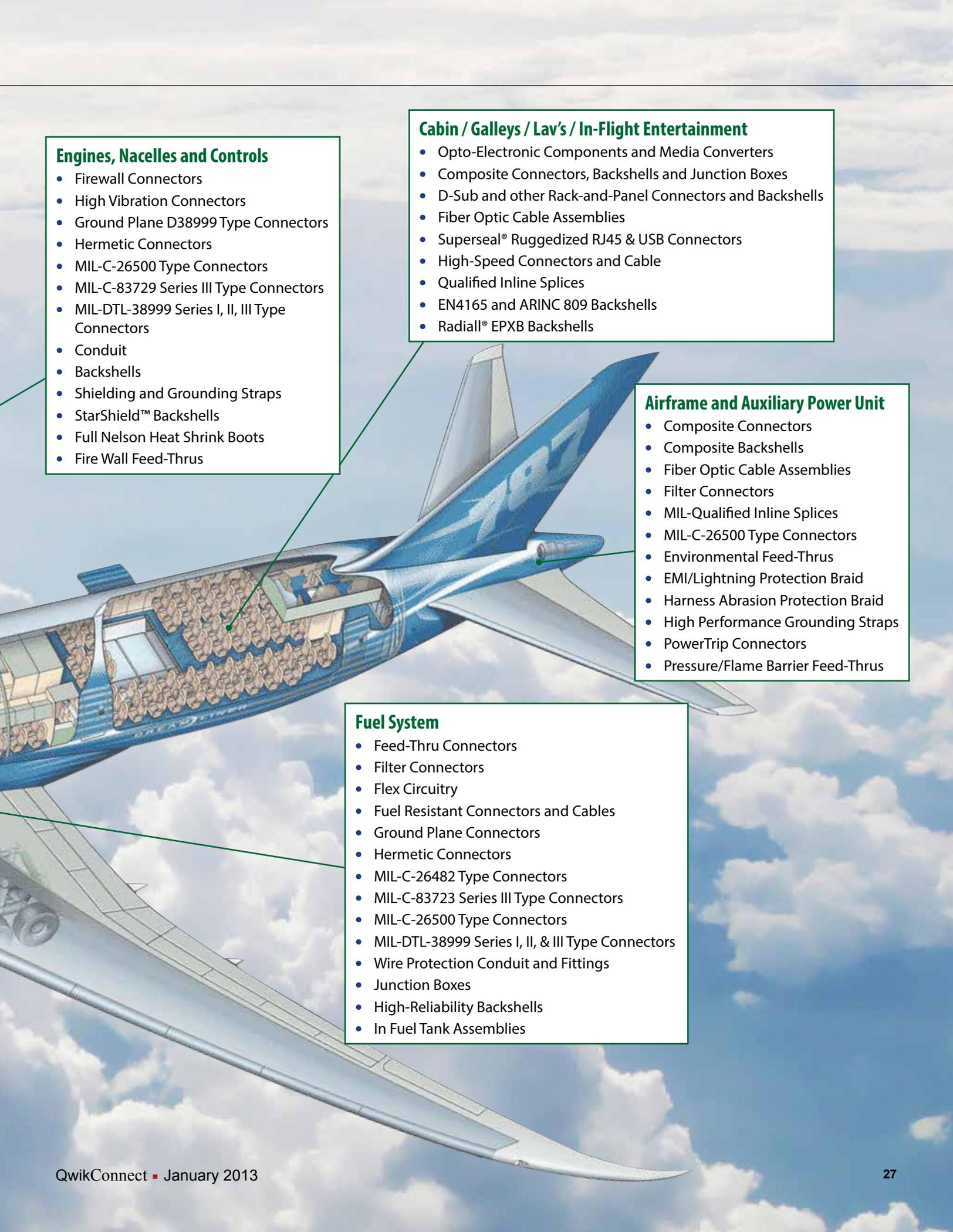

Engines, Nacelles and Controls

- Firewall Connectors
- High Vibration Connectors
- Ground Plane D38999 Type Connectors
- Hermetic Connectors
- MIL-C-26500 Type Connectors
- MIL-C-83729 Series III Type Connectors
- MIL-DTL-38999 Series I, II, III Type Connectors
- Conduit
- Backshells
- Shielding and Grounding Straps
- StarShield™ Backshells
- Full Nelson Heat Shrink Boots
- Fire Wall Feed-Thrus

Cabin / Galleys / Lav's / In-Flight Entertainment

- Opto-Electronic Components and Media Converters
- Composite Connectors, Backshells and Junction Boxes
- D-Sub and other Rack-and-Panel Connectors and Backshells
- Fiber Optic Cable Assemblies
- Superseal® Ruggedized RJ45 & USB Connectors
- High-Speed Connectors and Cable
- Qualified Inline Splices
- EN4165 and ARINC 809 Backshells
- Radiall® EPXB Backshells

Airframe and Auxiliary Power Unit

- Composite Connectors
- Composite Backshells
- Fiber Optic Cable Assemblies
- Filter Connectors
- MIL-Qualified Inline Splices
- MIL-C-26500 Type Connectors
- Environmental Feed-Thrus
- EMI/Lightning Protection Braid
- Harness Abrasion Protection Braid
- High Performance Grounding Straps
- PowerTrip Connectors
- Pressure/Flame Barrier Feed-Thrus

Fuel System

- Feed-Thru Connectors
- Filter Connectors
- Flex Circuitry
- Fuel Resistant Connectors and Cables
- Ground Plane Connectors
- Hermetic Connectors
- MIL-C-26482 Type Connectors
- MIL-C-83723 Series III Type Connectors
- MIL-C-26500 Type Connectors
- MIL-DTL-38999 Series I, II, & III Type Connectors
- Wire Protection Conduit and Fittings
- Junction Boxes
- High-Reliability Backshells
- In Fuel Tank Assemblies

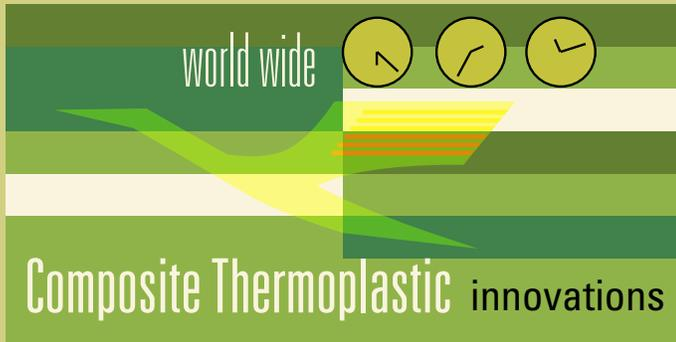

Weight-Saving Composites

Interconnect products made of composite materials offer significant advantages over steel or aluminum: They're lighter. They don't rust. They don't rattle loose. The ability to design composite components that take advantage of these properties while still meeting form, fit and function requirements is no simple task.

Glenair is the recognized leader in composite thermoplastic research and development for the interconnect accessory industry. In fact, no one else has tooled even a fraction of the composite thermoplastic connectors and accessories available today from Glenair. The product line includes circular and rectangular connectors and backshells, cable junction boxes, conduit, conduit fittings, protective covers, shielding, shielding support rings, and more. It is an ongoing goal at Glenair, largely achieved at this point, to be able to offer equivalent function composite thermoplastic interconnect components for the complete range of interconnect products we produce in metal.

Glenair composite components are produced in injection molded and, in certain cases, machined versions ideally suited for use in harsh environments where resistance to high temperatures, outgassing, corrosive fluids, fire, and shock and vibration is required. Glenair composites are ASTM E595 space rated, and are qualified to the shock, vibration, thread strength and bend moment requirements of MIL-DTL-38999 and SAE AS85049. The materials also meet stringent EMI/RFI/HIRF and indirect lightning strike performance specifications.

Glenair has the largest and most experienced staff of composite engineers and manufacturing experts in the interconnect accessory industry. Their combined expertise insures Glenair composite products mate correctly with both metal and composite connectors and meet the customer's most stringent performance requirements. All Glenair designs provide a dimensionally stable and cadmium-free alternative to plated aluminum and brass.

Glenair composite material options include Ultem® (PEI), Amodel® (PPA), Ryton® (PPS), Torlon® (PAI), PEEK, Siltem and LCP. Base materials can be augmented with conductive and non-conductive additives and reinforcing fibers to meet specific functional specifications. As mentioned, each composite material has its own specific structural properties. The following is a brief introduction to the most common materials used by Glenair:

Ultem® (PEI) is an amorphous thermoplastic available in extruded bars for machining and pellets for injection molding. The material combines high performance with good processing characteristics and offers high heat resistance, high strength modulus and broad chemical resistance. Ultem 2300 is a 30 percent glass filled thermoplastic which displays excellent property retention and resistance to environmental stress. Ultem can be further reinforced with conductive fibers, or plated, for EMI resistance. Ultem performs in operating environments up to 378°F (192°C) long term and 410°F (210°C) short term. Ultem meets ASTM E595 outgassing, 14 CFR Part 25 flammability, and zero halogen outgassing requirements.

Ryton® (PPS) is a semi-crystalline, high temperature injection molded material. It has good mechanical properties and excellent chemical resistance at elevated temperatures. Different grades are available including glass filled and glass/mineral filled versions. Ryton R4-XT is a 40 percent glass filled version engineered for improved knit-weld line characteristics. Ryton exhibits excellent resistance to prolonged exposure to high temperatures, up to 500°F (260°C).

Glenair's G-FLEX polymer (polyetherimide-siloxane) is a high-temperature material used primarily to produce annular convoluted tubing. The material is offered in a broad range of operating temperatures, has exceptional flexibility and good crush resistance. In certain applications, G-FLEX is a suitable alternative to costlier halogen-free composite polymers such as PEEK (polyetheretherketone), a semi-crystalline thermoplastic that operates at extremely high temperatures.

Next-Generation Composite Interconnect Technologies From Glenair Engineering

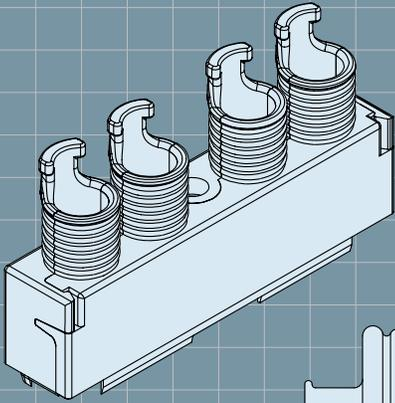

EN4165
BACKSHELLS

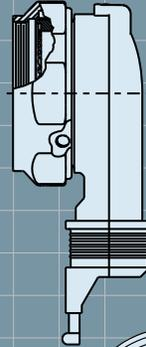

BANDING
BACKSHELLS

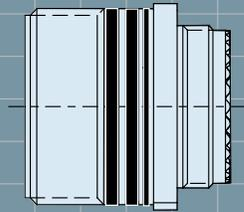
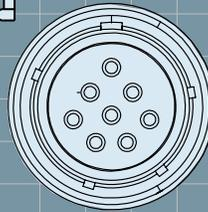
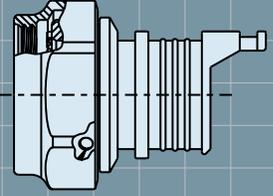

FIBER-OPTIC, COAXIAL, QUADRAX
AND GENERAL-DUTY CONNECTORS

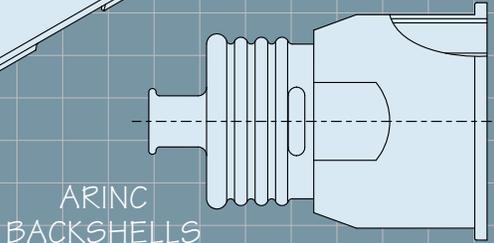

ARINC
BACKSHELLS

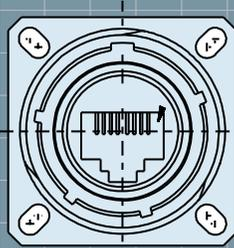
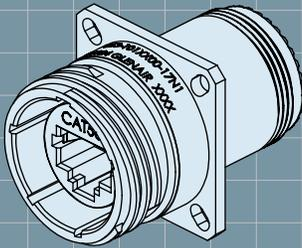

RJ45 CONNECTORS

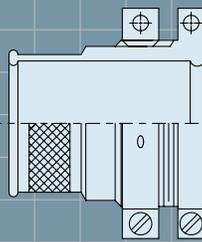
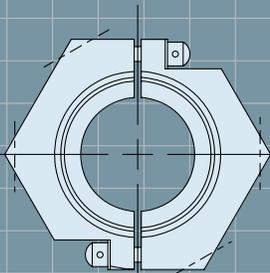
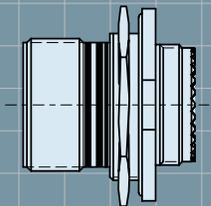
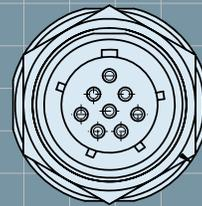

RFI SPLIT-SHELL
FEED-THRUS

PRESSURE/
FLAME BARRIER
FEED-THRUS

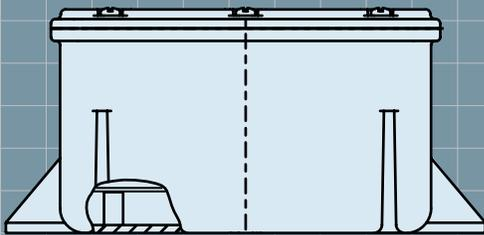
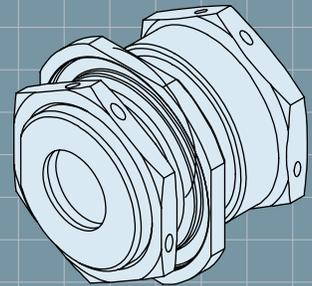

JUNCTION BOXES

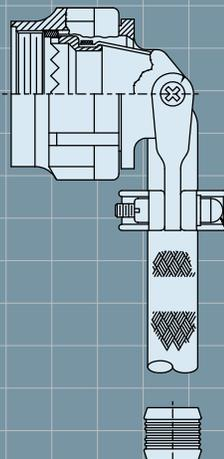

BACKSHELLS WITH INTEGRAL
BRAID SOCK AND SPLIT
SUPPORT RING

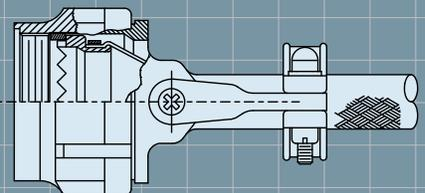



ABOUT AIRPLANE TURBULENCE

A recent *Popular Mechanics* article explained the three kinds of airplane turbulence, and what you can do to stay safe on a plane. Federal Aviation Administration statistics show turbulence injures 58 airliner passengers per year. Turbulence is the number one cause of injuries to passengers and flight attendants in nonfatal accidents, and two-thirds of those injuries happen above 30,000 feet.

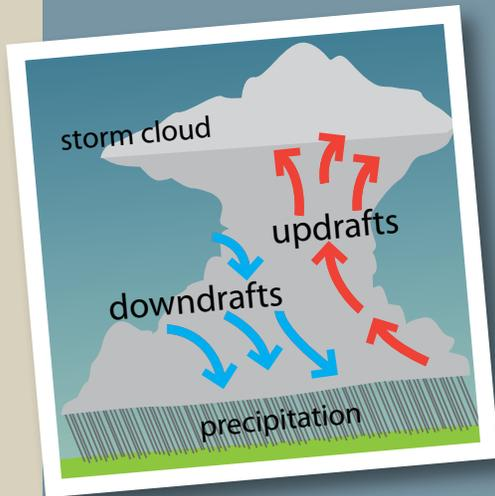

TURBULENCE DURING STORMS

Convective weather patterns, such as thunderstorms, are only form of turbulence that pilots, and the meteorologists who back them up, can actually see. Strong updrafts and downdrafts in the heart of a storm can shove an airplane up or down as much as 6,000 feet. While the worst turbulence occurs in the middle of a storm—typically between 12,000 to 20,000 feet—storms and the turbulence they create can rise as high as 50,000 feet, well above the 30,000 to 40,000-foot ceiling of most airliners. Weather forecasts, radar, and updates from the ground and other aircraft can help pilots steer clear of the worst weather. These storms bring other dangers, such as lightning and hail that can break cockpit windows or damage engines.

TURBULENCE OVER MOUNTAINS

When strong winds blow perpendicular to mountain ranges, air flowing over the top of a mountain produces turbulence in the form of waves when it reaches the other side, just as ocean waves break on the lee side of a submerged reef. Although they can't see the turbulence itself, pilots can anticipate so-called "mountain waves" as they fly over mountains because they are so common there. A further tipoff when conditions are right for mountain waves is the presence of lens-shaped lenticular clouds in the vicinity.

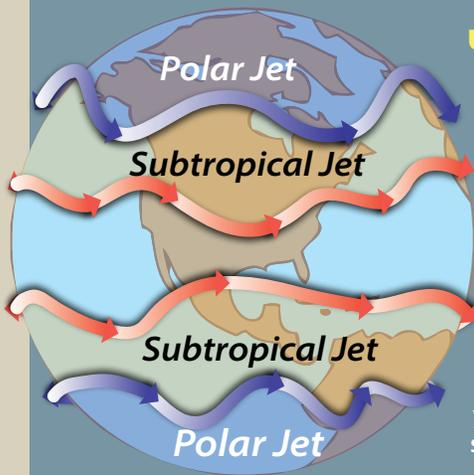
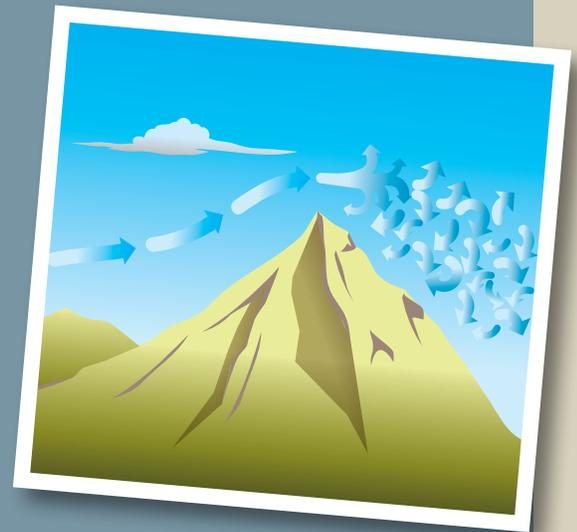

UNEXPECTED TURBULENCE

Most insidious, clear-air turbulence is invisible, comes without warning and occurs any time during a flight. One of the main culprits of clear-air turbulence is the boundary between the jet stream—that aerial river that forms where arctic air masses meet warmer air from the south—and the slower-moving air adjacent to it. This invisible boundary shifts un-predictably, and woe to any unstrapped passenger in a jet that crosses it. If an aircraft has passed through the area ahead of your airplane, your pilot might get an advance warning of turbulence ahead.

Even the worst turbulence is no cause for alarm—by itself. Airplanes are built to withstand even a severe turbulence event. Passenger safety during turbulence is primarily the responsibility of the passengers themselves. Buckle your seatbelt, just as pilots and flight attendants recommend, anytime you're seated.

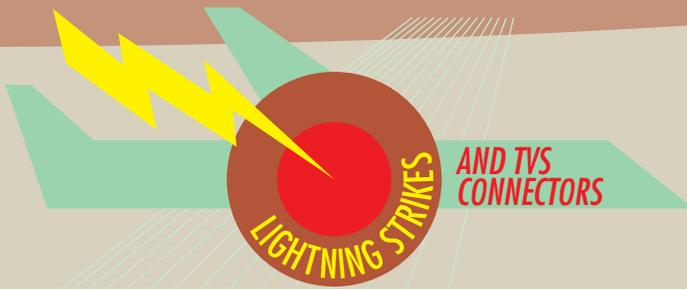

Lightning Strike and EMP Management

Aircraft may be struck by lightning as often as once a year. The effect of lightning strikes on electrical wiring systems and the electronic equipment the wiring systems interconnect dictates the range of protective shielding, grounding and transient voltage suppression technologies required.

The widespread use of composite materials as a lighter weight alternative to aluminum in airframe structures and helicopter blades contributes to the complexity of managing lightning strike damage in aircraft. Composite materials are inherently less electrically conductive than aluminum and as a result suffer relatively more physical damage from transient voltage currents than metal structures. Less conductive, composite fuselages can also allow a larger percentage of lightning currents to flow into electrical wiring. Composite skins also provide relatively less electromagnetic shielding of onboard systems from lightning-induced electromagnetic fields.

The expanded use of sensitive digital systems such as cockpit instruments and indicators, digital flight recorders, cargo and aircraft door sensors, and so on means that modern aircraft are potentially more susceptible to the indirect effects of lightning—including induced voltages in electrical wiring—that may result in system malfunctions or circuit damage to electronic equipment.

Lightning interaction mechanisms and protection techniques are now well known disciplines in aircraft design. But innovations are still required, particularly in support of efforts to reduce the size, weight and assembly complexity of interconnect cabling and grounding technologies. Wire and cable braided shielding, for example, plays a key role in electromagnetic compatibility and is also used as a flexible and durable solution to spot grounding of electrical equipment as well other functions including:

- Grounding of airframe sections
- Dissipation of static build-up in a composite structures
- Conducting lightning strike current pulses to ground
- Dissipating lightning strike energy
- Grounding of individual moving parts in complex equipment such as landing gear

The specification of cable braiding and ground straps, particularly lightweight composite and micro-filament versions designed to reduce aircraft all up weights, is an evaluation process that weighs such parameters as:

- Weight and conductivity

- Mechanical durability, resistance
- Ability to withstand a high-current pulse
- Attenuation of EMI signals across the braid
- Rapid heat distribution
- Bend cycle durability

Microfilament braid offers advantages in virtually every category due to the ability to fine-tune the makeup of the material cross-section (core material, cladding and protective plating) to the exact requirements of each application. Glenair AmberStrand® and ArmorLite lightweight microfilament braids are approved for use by every major airframe and equipment manufacturer.

Designers must protect systems from transient over-voltages as a result of nearby lightning strikes. Placing transient suppression diodes within the system—preferably inside a connector instead of some ad hoc location—is one of the most effective ways to protect electronic systems from lightning strikes and other sources of electromagnetic pulse.

Diodes work something like a pressure valve on a home water heater—if the pressure within the chamber exceeds a certain value, the valve opens, allowing steam and liquid to escape. Similarly, diodes in electronic systems protect components within the circuit by shorting to ground transient spikes that exceed the diode's clamp voltage.

Since lightning strikes can be positively or negatively charged, special bi-directional diodes are available. If a system does not already have transient suppression diodes somewhere “in the box,” Glenair can include diodes on EMI filtered or non-filtered connectors.

When specifying transient voltage suppression for a given lightning strike waveform (or “shape”) and level (or magnitude), diodes must be compatible with EMI filter dielectric withstanding voltage (DWV) rating.

Diode power is rated in watts for a given pulse shape and pulse duration. Typically the reference values are given for a 10/1000µs pulse. This means that the diode can absorb the peak power rated for a pulse with 10µs rise time and 1000µs fall time. If the system is subjected to a different pulse shape or duration the value must be adjusted accordingly.

For high speed applications, diode capacitance and trace inductance are critical. Glenair engineers will recommend a suitable design for each application. This may involve using extremely compact surface mount diodes within the pin field of the connector.

- ▶ *Glenair TVS connectors are a weight and space-saving solution designed to prevent catastrophic EMP failure in civil aircraft.*



Transient Voltage Suppression Prevents Catastrophic EMP Failure in Military and Commercial Aircraft

Configurable, Fast-Turnaround TVS CONNECTORS

- Electromagnetic Pulse (EMP) Protection
- Lightning Protection
- Saves weight and space
- Superior Performance
- D38999 Series III Type

Sym.	Material	Finish Description
ME	Aluminum	Electroless Nickel
MT		Nickel Fluorocarbon Polymer (Ni-PTFE)
NF		Cadmium O.D. over Electroless Nickel
ZN		Zinc-Nickel over Electroless Nickel
ZL	Stainless Steel	Electro-Deposited Nickel

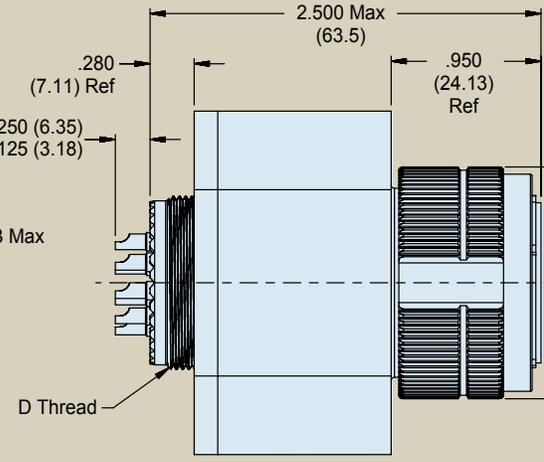
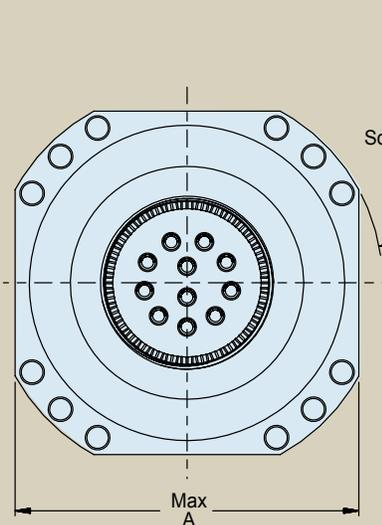

RTCA DO-160 Waveform See Notes 4 and 6	Level	Open Circuit Voltage/ Short Circuit Current V/A	Reverse Standoff Voltage	Maximum Clamping Voltage	Recommended Minimum Diode Power (Watts)	
Waveform 3 Damped Sine 	1	100/4	5 To 60	9.2 To 96.8	600	
	2	250/10	5 To 150	9.2 To 243	600	
	3	600/24	5 To 170	9.2 To 275	600	
	4	1500/60	5 To 54	9.2 To 87.1	600	
			58 To 150	93.6 To 243	1,500	
			160 To 170	259 To 275	3,000	
	5	200/128	5 To 22	9.2 To 35.5	600	
			24 To 60	38.9 To 96.8	1,500	
			64 To 130	103 To 209	3,000	
			150 To 170	243 To 275	5,000	
Waveform 4 Double Exponential 6.4 X 69usec 	1	50/10	5 To 30	9.2 To 48.4	600	
	2	125/25	5 To 75	9.2 To 121	600	
	3	300/60	5 To 17	9.2 To 27.6	600	
			18 To 26	29.2 To 42.1	3,000	
			28 To 110	45.4 To 177	5,000	
			120 To 170	193 To 275	15,000***	
	4	750/150	5 To 8.5	9.2 To 14.4	3,000	
			9 To 60	15.4 To 96.8	5,000	
			64 To 170	103 To 275	15,000***	
			5 To 24	9.2 To 38.9	5,000	
			26 To 78	42.1 To 126	15,000***	
	5	1600/320	90	147	30,000***	
	Waveform 5A Double Exponential 40 X 120usec 	1	50/50	5 To 30	9.2 To 48.4	1,500
		2	125/125	5 To 75	9.2 To 121	3,000
		3	300/300	5 To 15	9.2 To 24.4	3,000
17 To 170				26.7 To 275	15,000***	
180				291	30,000***	
4		750/750	17 To 22	26.7 To 35.5	15,000***	
			30 To 48	55.2 To 77.4	30,000***	
5		1600/1600		N/A		

Application Notes:

1. Assembly to be identified with Glenair's name, part number and date code, space permitting.
2. Material/Finish:
Shell housing and coupling nut - See Table II.
Grounding spring - Beryllium copper alloy/ Electroless nickel.
Insulators - High grade rigid dielectric/N.A.
Seals - Fluorosilicone/N.A.
Contacts - Copper alloy/Gold over nickel per ASTM B 488.
Inserts IAW with MIL-STD-1560. Arrangement shown is for reference only.
3. Electrical performance:
Specific diode voltage code options per Table III.
Diode wattage based on 10x1000us peak power waveform.

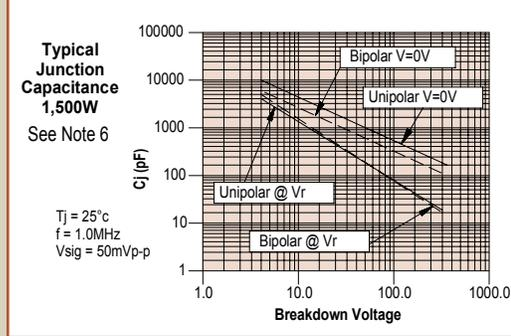

***Consult Factory For Diode Power Ratings Above 5,000W.

Termination
Solder Cup

Flange Mounting Style
N = Not Applicable

P S N N

Alternate Key Position per MIL-DTL-38999
A, B, C, D, E
N = Normal U = Universal
Do Not Mate Universal with Universal Receptacle

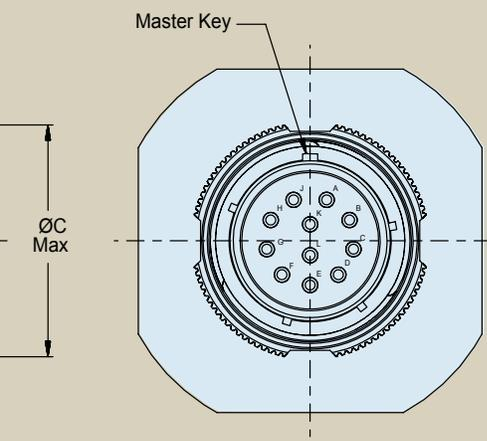

- Clamping time:
Unipolar - Less than 1 nanosecond, 0V to breakdown.
Bipolar - less than 5 nanoseconds, 0V to breakdown.
- Glenair will assign a diode net list code and provide a separate net list drawing containing specific electrical requirements. Customer to fill out applicable columns of Table V on the single sheet insert and return to Glenair.
- Consult factory for low capacitance, ground requirements, power ratings above 5,000W, special test requirements or other modifications.
- Operating temperature: -55°C to +125°C (-67°F to 257°F).

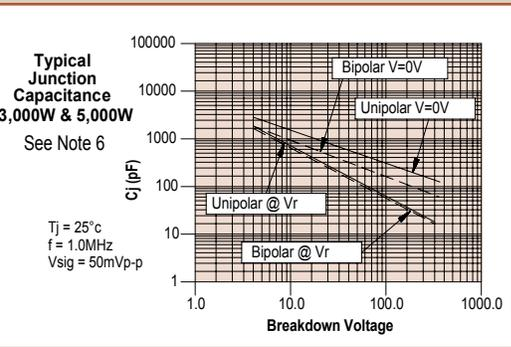

Shell Size	A Max	ØB Max	ØC Max	D Thread
9	1.000 (25.4)	1.300 (33.0)	.858 (21.8)	M12 X 1.0-6g 0.100R
11	1.400 (35.6)	1.700 (43.2)	.984 (25.0)	M15 X 1.0-6g 0.100R
13	1.700 (43.2)	2.000 (50.8)	1.157 (29.4)	M18 X 1.0-6g 0.100R
15	1.700 (43.2)	2.000 (50.8)	1.280 (32.5)	M22 X 1.0-6g 0.100R
17	2.000 (50.8)	2.300 (58.4)	1.406 (35.7)	M25 X 1.0-6g 0.100R
19	2.200 (55.9)	2.500 (63.5)	1.516 (38.5)	M28 X 1.0-6g 0.100R
21	2.300 (58.4)	2.600 (66.0)	1.642 (41.7)	M31 X 1.0-6g 0.100R
23	2.600 (66.0)	2.900 (73.7)	1.768 (44.9)	M34 X 1.0-6g 0.100R
25	2.900 (73.7)	3.200 (81.3)	1.890 (48.0)	M37 X 1.0-6g 0.100R

Diode Voltage Code	Reverse Standoff Voltage (V)	Breakdown Voltage (V)		Max Reverse Leakage (µA)			Test Current (mA)	Maximum Clamping Voltage (V)	Diode Availability		
		Min	Max	1,500W	3,000W	5,000W			1,500W	3,000W	5,000W
5.0	5.0	6.40	7.00	800	800	N/A	10	9.2	X	X	
6.0	6.0	6.67	7.37	800	800	N/A	10	10.3	X	X	
6.5	6.5	7.22	7.98	500	500	N/A	10	11.2	X	X	
7.0	7.0	7.78	8.60	200	200	N/A	10	12.0	X	X	
7.5	7.5	8.33	9.21	100	100	N/A	1	12.9	X	X	
8.0	8.0	8.89	9.83	50	50	N/A	1	13.6	X	X	
8.5	8.5	9.44	10.40	20	20	N/A	1	14.4	X	X	
9.0	9.0	10.00	11.10	10	10	N/A	1	15.4	X	X	
10	10.0	11.10	12.30	5	5	N/A	1	17.0	X	X	
11	11.0	12.20	13.50	1	2	N/A	1	18.2	X	X	
12	12.0	13.30	14.70	1	2	800	1*	19.9	X	X	X
13	13.0	14.40	15.90	1	2	500	1*	21.5	X	X	X
14	14.0	15.60	17.20	1	2	200	1*	23.2	X	X	X
15	15.0	16.70	18.50	1	2	100	1	24.4	X	X	X
16	16.0	17.80	19.70	1	2	50	1	26.0	X	X	X
17	17.0	18.90	20.90	1	2	20	1	27.6	X	X	X
18	18.0	20.00	22.10	1	2	10	1	29.2	X	X	X
20	20.0	22.20	24.50	1	2	5	1	32.4	X	X	X
22	22.0	24.40	26.90	1	2	5	1	35.5	X	X	X
24	24.0	26.70	29.50	1	2	5	1	38.9	X	X	X
26	26.0	28.90	31.90	1	2	5	1	42.1	X	X	X
28	28.0	31.10	34.40	1	2	5	1	45.4	X	X	X
30	30.0	33.30	36.80	1	2	5	1	48.4	X	X	X
33	33.0	36.70	40.60	1	2	5	1	53.3	X	X	X
36	36.0	40.00	44.20	1	2	5	1	58.1	X	X	X
40	40.0	44.40	49.10	1	2	5	1	64.5	X	X	X
43	43.0	47.80	52.80	1	2	5	1	69.4	X	X	X
45	45.0	50.00	55.30	1	2	5	1	72.7	X	X	X
48	48.0	53.30	58.90	1	2	5	1	77.4	X	X	X
51	51.0	56.70	62.70	1	2	5	1	82.4	X	X	X
54	54.0	60.00	66.30	1	2	5	1	87.1	X	X	X
58	58.0	64.40	71.20	1	2	5	1	93.6	X	X	X
60	60.0	66.70	73.70	1	2	5	1	96.8	X	X	X
64	64.0	71.10	78.60	1	2	5	1	103.0	X	X	X
70	70.0	77.80	86.00	1	2	5	1	113.0	X	X	X
75	75.0	83.30	92.10	1	2	5	1	121.0	X	X	X
78	78.0	86.70	95.80	1	2	5	1	126.0	X	X	X
85	85.0	94.40	104.00	1	2	5	1	137.0	X	X	X
90	90.0	100.00	111.00	1	2	5	1	146.0	X	X	X
100	100.0	111.00	123.00	1	2	5	1	162.0	X	X	X
110	110.0	122.00	135.00	1	2	5	1	177.0	X	X	X
120	120.0	133.00	147.00	1	2	5	1	193.0	X	X	X
130	130.0	144.00	159.00	1	2	5	1	209.0	X	X	X
150	150.0	167.00	185.00	1	2	5	1	243.0	X	X	X
160	160.0	178.00	197.00	1	2	5	1	259.0	X	X	X
170	170.0	189.00	209.00	1	2	5	1	275.0	X	X	X
180	180.0	201.00	222.00	1	N/A	N/A	1	292.0	X		
200	200.0	224.00	247.00	1	N/A	N/A	1	324.0	X		
220	220.0	246.00	272.00	1	N/A	N/A	1	356.0	X		
250	250.0	279.00	309.00	1	N/A	N/A	1	405.0	X		
300	300.0	335.00	371.00	1	N/A	N/A	1	486.0	X		
350	350.0	391.00	432.00	1	N/A	N/A	1	567.0	X		
400	400.0	447.00	494.00	1	N/A	N/A	1	648.0	X		
440	440.0	492.00	543.00	1	N/A	N/A	1	713.0	X		

* Indicated Test Current Is To Be 10mA For 5,000W Devices Only.
** All Diode Options Are Available In Bipolar And Unipolar Configurations.

TVS Diode Requirement Form

Connector Pin#		Diode Voltage Code 5.0 - 440	Diode Polarity Bipolar Unipolar	Diode Wattage 1,500W / 3,000W 5,000W	Connector Pin #	Diode Voltage Code 5.0 - 440
1	A				44	w
2	B				45	x
3	C				46	y
4	D				47	z
5	E				48	AA
6	F				49	BB
7	G				50	CC
8	H				51	DD
9	J				52	EE
10	K				53	FF
11	L				54	GG
12	M				55	HH
13	N				56	JJ
14	P				57	KK
15	R				58	LL
16	S				59	MM
17	T				60	NN
18	U				61	PP
19	V				62	
20	W				63	
21	X				64	
22	Y				65	
23	Z				66	
24	a				67	
25	b				68	
26	c				69	
27	d				70	
28	e				71	
29	f				72	
30	g				73	
31	h				74	
32	i				75	
33	j				76	
34	k				77	
35	m				78	
36	n				79	
37	p				80	
38	q				81	
39	r				82	
40	s				83	
41	t				84	
42	u				85	
43	v				86	

Customer Note: Please fill out the appropriate columns and return to Glenair. Glenair will assign a diode net list code and provide a separate net list drawing containing spec

Diode Polarity Bipolar Unipolar	Diode Wattage 1,500W / 3,000W 5,000W	Connector Pin #	Diode Voltage Code 5.0 - 440	Diode Polarity Bipolar Unipolar	Diode Wattage 1,500w / 3,000w 5,000w
		87			
		88			
		89			
		90			
		91			
		92			
		93			
		94			
		95			
		96			
		97			
		98			
		99			
		100			
		101			
		102			
		103			
		104			
		105			
		106			
		107			
		108			
		109			
		110			
		111			
		112			
		113			
		114			
		115			
		116			
		117			
		118			
		119			
		120			
		121			
		122			
		123			
		124			
		125			
		126			
		127			
		128			

ific electrical requirements. Consult factory for low capacitance, ground requirements, power ratings above 5,000W, special test requirements or other modifications.



optic media interconnecting each transceiver is manually terminated in a complex and labor-intensive fashion. The opportunity to reduce weight and package size, *plus* assembly and maintenance complexity, has led Glenair to develop a revolutionary new active component product series that takes all the pain out of conventional fiber optic interconnect solutions. *Ideally suited for in-flight entertainment and other data-intensive commercial aircraft applications*, Glenair active opto-electronics significantly reduce assembly time and complexity compared to conventional fiber optic systems. The complete product line includes Size #8 cavity opto-electronic contacts for easy integration into ARINC connectors or our MIL-DTL-38999 type receptacle.

Opto-Electronic Media Conversion for IFE

The conversion of signals between electrical and optical domains is a necessary step in all fiber optic interconnection systems. Typically, heavy transceivers housed in equipment consoles are utilized to accomplish this function. Fiber

050-301 (Size 8 cavity opto-electronic contact) and 050-307 (ELIO® contact for ARINC 600 connectors)

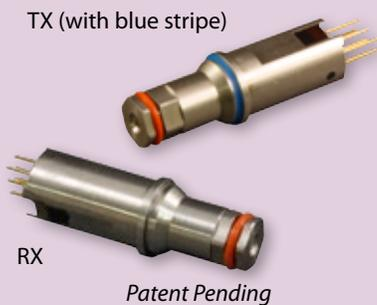

KEY FEATURES

- Front-release, front-insert, front-removable Size #8 OE converter designed for ARINC 600
- ARINC 664, 801, 803, 804, and 818 standard Compliant
- Data rates from 100Mbps to 4.25 Gbps
- Supports Fast and Gigabit Ethernet, AFDX, 1x/2x Fibre Channel, DVI, HDMI, SFPDP, Serial Rapid I/O (sRIO).
- 100 ohms differential CML inputs with Tx Fault and Tx Disable
- Link distances up to 550 meters with multimode 50/125µm or 62.5/125 µm fiber
- Single 3.3v power supply
- ARINC 801 1.25mm ceramic fiber ferrule
- 050-307 mates with ELIO® 2.5mm termini

050-304 MIL-DTL-38999 type receptacle connector with size 8 opto-electronic contacts

KEY FEATURES

- Supports up to 34Gbps aggregate transmission bandwidth in a single connector
- MIL-STD-1560 and custom arrangements from 1 to 8 size 8 cavities
- Operating temperatures -40 to +85C
- Transmitter, Receiver or Transceiver configurations
- 050-301 contacts to support ARINC 801 1.25mm fiber optic interconnect, 100Mbps to 4.25Gbps per contact
- 050-307 Active size 8 contacts to support 2.5mm Fiber Optic contact systems, 100Mbps to 4.25Gbps per contact
- 050-308 Active size 8 contacts to support ARINC 801 1.25mm fiber optic contact system, 10Mbps to 200Mbps, 1300nm LED
- PC tail electrical interfaces or custom micro-coax or flex to PCB interfaces available
- Connector rear face contains standoffs to allow direct mechanical attachment to PCB.



050-313 Opto-electronic transceiver with MIL-DTL-38999 type connector interface



KEY FEATURES

- IEEE 802.3-2005 Gigabit Ethernet standard compliant
- -40°C to +85°C operating temperature range
- Ideal for harsh environment applications
- MIL-STD-810 mechanical shock and vibration compliance
- MIL-STD-1344 immersion resistance compliance
- Up to 550 Meters for VCSEL 850nm version with Multimode fiber
- Power supply operation from 3.3V
- IP67 in Unmated Condition



Proven Performance Connectors, Backshells, and Accessories for IFE

The specification of proven interconnect technologies with real-world application pedigrees is one of the most important design requirements for IFE systems. Glenair offers more tested and tooled interconnect products for IFE than any other supplier in the industry. Here is a selection:

Mighty Mouse and Micro-Crimp: Compatible ultraminiature high-speed circular and rectangular connector solutions for in-flight entertainment



Series 79 Micro-Crimp Sealed Receptacle



Series 79 Micro-Crimp Shielded Plug



Series 80 Mighty Mouse High-Speed



Series 80 Mighty Mouse SuperSeal™ USB



Series 80 Mighty Mouse "Flop Lid" protective cover

M24308 D-Sub Solutions: High performance, ruggedized, lightweight alternatives to standard D-subminiature products



Split-shell D-subminiature composite backshell



Split-shell M24308 composite backshell



Series 28 HiPer-D



Composite D-subminiature backshells with alternative routing and cable entry ports



Flex-D Composite Conduit and Aluminum M24308 Backshell

Larger form factor rectangular backshells for IFE applications



Composite EMI/RFI banding backshell with Qwik-Ty strain relief for Radiall® EPXB® connectors

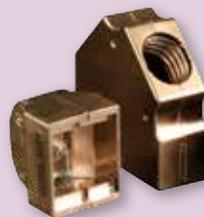

Composite EN4165 fiber optic/electrical backshells



Backshells for Radiall® EPX® series connectors



ARINC series backshells

Selected high-performance connector accessories with proven performance in IFE applications



Ultra-short banding/strain relief circular backshell



SuperSeal™ USB with spring-loaded protective cover



Self-locking, anti-decoupling protective cover



Ultra-low profile right angle backshell



Starshield "zero length" shield termination backshell

Vibration and Shock



Aircraft Vibration and Shock

All aircraft vibrate. And they do so under harsh environmental conditions such as temperature extremes and high altitude. Interconnect components must be designed, tested and certified to survive specific levels of vibration and shock, under harsh conditions and over their entire service life. Design standards such as MIL-STD-810F and RTCA DO-160E are used as benchmarks in vibration and shock testing. The DO-160 standard was first published on January 25, 1980 to specify test conditions for the design of avionics electronic hardware in airborne systems. Since then the standard has undergone subsequent revisions up through revision G.

Testing is application specific and is applied differently, for example, for fixed versus rotary wing aircraft. A typical Glenair

connector performance benchmark might read:

No discontinuity of greater than 1 microsecond, no cracking, breaking or loosening of parts, plug shall not become disengaged from receptacle. Connectors shall meet electrical requirements after vibration test.

Mechanical design and packaging can contribute to connector and accessory capabilities in the area of vibration and shock, including:

Contact Retention and Normal Force

Heat from electrical or environmental sources can soften mated contacts over time and reduce contact retention force. Under extreme conditions of shock and vibration this loss of normal retention can result in unstable resistance across the interconnect. This is the case for all types of contacts—machined, drawn, stamped and twisted. But materials selection, fabrication and heat treating techniques can improve performance in these conditions and enable certain classes of contacts to resist high temperature stress relaxation for up to 1000 hours at 257°F (125°C) and thus perform at levels unmatched by other contact designs.



THE ALL-ELECTRIC AIRPLANE

All-electric aircraft run on electric motors rather than internal combustion engines, with the electricity coming from fuel cells, solar cells, ultra-capacitors, power beaming or batteries. Some “hybrid” concepts include small internal combustion engines primarily used to recharge the batteries powering electrical drive motors. Currently flying electric aircraft are mostly experimental demonstrators.



Cessna 172

Cessna developed an electrically powered Cessna 172 as a proof-of-concept in partnership with Bye Energy.

Icaro 2000 Trike

Icaro 2000 Trike is a single-seat ultralight trike, with a conventional hang glider and the Flytec HPD 10 10 kW (13 hp) engine.



Electravia ElectroLight

ElectroLight is an ultralight motorglider with an electric propulsion system and a silent propeller. With a Lithium-Polymer pack of 5.55 kWh (34 kg), the endurance was about 1.5 hours and the altitude gain about 3,000 m (9,843 ft).



Pipistrel Taurus Electro G2

The Taurus Electro G2 is a two-seat self-launching sailplane with a 54 hp (40 kW) engine that powers the aircraft using internally mounted lithium batteries for a 17-minute climb. At that point, the engine retracts and the aircraft soars as a sailplane.

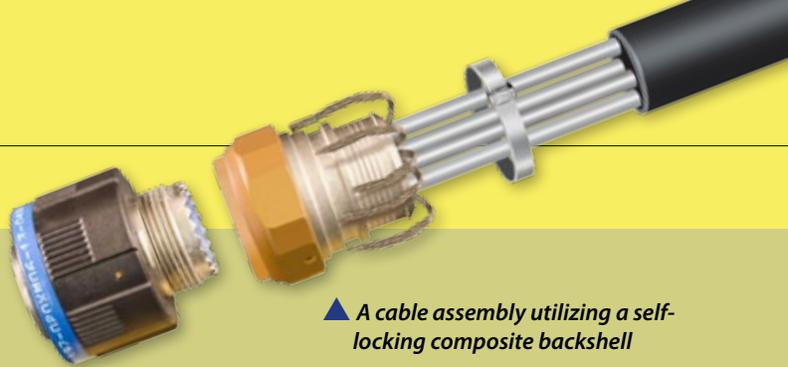

▲ A cable assembly utilizing a self-locking composite backshell



Anti-Vibration Connector Coupling

Various technologies, most commonly a ratchet mechanism, or other anti-decoupling feature in the plug coupling nut, can prevent de-mating under severe conditions of vibration and shock. MIL-DTL-38999 Series III is the most ubiquitous circular connector series that provides this feature. The addition of reverse bayonet coupling to cylindrical connectors (Glenair ITS Series) also improves their reliability and mating performance.



▶ Anti-decoupling MIL-DTL-5015 (ITS) reverse-bayonet connectors

Self-Locking Rotatable Backshell Coupling

Like connectors, backshells may be equipped with ratchet mechanisms (and other anti-decoupling devices) to prevent de-mating in high-vibration applications. Interlocking teeth in the connector-to-backshell interface contribute to performance and as well facilitate the clocking of angled backshells.

Reduced Harmonic Resonance

The use of composite plastic in place of metal materials also contributes to vibration dampening in aircraft applications. Polymer plastics are less subject to harmonic resonance than metals, due to their lighter weight and inherent attenuating properties. Threaded components made from these materials are far less likely to vibrate loose when subjected to prolonged of vibration and shock.



PC-Aero Elektra One

The Elektra One is a development of a commercial electric aircraft design by PC-Aero of Germany. The single seat composite aircraft had its first flight in early 2011. Powered by a 21 hp (16 kW) electric motor, the Elektra One is expected to have an endurance of three hours, with a 100 mph (161 km/h) top speed.

Volta Volare GT4

The Volta Volare GT4 is expected to fly up to 300 miles on electric power alone. In hybrid mode, a supercharged 1.5-liter displacement gasoline engine with a 23 gallon (86 l) fuel tank will back up the electric system and extend the GT4's range up to 1,000 miles (1650 km).

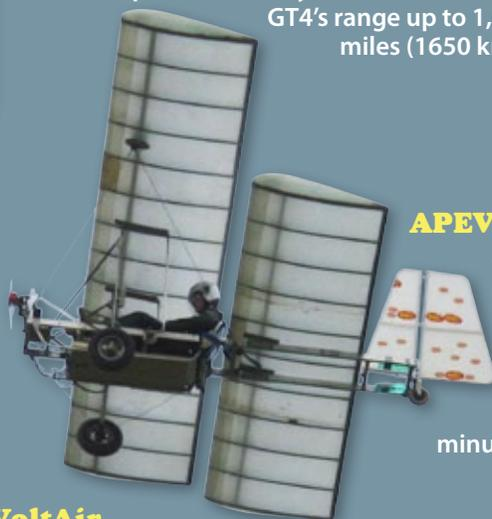

APEV Pouchelec

The French APEV Pouchelec is an electric development of the APEV Pouchel Light, powered by a 15 kW (20 hp) AGNI 119R electric motor and a Kokam Lithium-ion polymer battery pack, which gives a 30 minute flight endurance.

EADS VoltAir

EADS proposes a nitrogen-cooled all-electric commercial airliner called VoltAir that could be viable within 25 years. Two next-generation lithium-air batteries would power two superconducting electric motors, which would in turn drive two co-axial, counter-rotating shrouded propellers at the rear of the aircraft. Advanced carbon fiber composite airframe design, aerodynamics and low weight would make the airliner quite easy to push through the air.





PORTABLE ELECTRONICS AND AIRPLANES

To the question about why portable electronics are restricted on commercial air flights, no less an authority than *Scientific American* weighed in recently. Their conclusion: "We just don't know." Thus, airlines err on the side of caution, asking people to turn off their gadgets during takeoff and landing.

Some facts about portable electronics use on airplanes:

1. Radio-frequency emissions from cell phones, laptops and other electronics can occur at the same frequencies used by aircraft communication, navigation and surveillance radio receivers. These emissions could cause fluctuations in navigation readouts, problems with other flight displays, and interference with air traffic communications.



2. It's less risky to let passengers use portable electronics (with the exception of cell phones) at cruising altitudes above 3,000 meters because the flight crew would have more time to diagnose and address any possible interference than they would during takeoff or landing.
3. Because passengers bring such a variety of portable electronics onboard in so many different states of function or disrepair, the FAA can't assure that none of them will interfere with flight instrumentation. The agency thus tells carriers to prohibit their use completely during critical phases of flight.



4. The FAA has begun allowing flight crews to use tablet computers including iPads in the cockpit. But this is not as surprising as it might sound: Crews have actually been using portable computers called "electronic flight bags" since the early 1990s to replace printed aircraft operating manuals, flight crew operating manuals and navigational charts.

5. Portable voice recorders, hearing aids, electric shavers and heart pacemakers do not need to be shut off at any time during a flight because their signals don't interfere with aircraft systems.



6. For any gadget not specifically mentioned by FAA rules, an airline must demonstrate that this device doesn't interfere with aircraft operation before it is allowed on board.



7. The U.S. Federal Communications Commission (FCC) has banned the inflight use of 800 MHz cell phones since 1991 to keep cell networks from interfering with airplane instrumentation. (Before that cell phones were banned because they didn't fit in the overhead luggage compartment or safely under a passenger's seat.)



8. The FCC and FAA work in tandem to ban cell phones on airplanes. Even if a cell phone were to meet the FAA's safety requirements, an airline would need an exemption from the FCC rule for that cell phone to be used inflight. Likewise, if the FCC rescinds its ban, the FAA would require an airline to show that the use of a specific model of phone won't interfere with the navigation and communications systems of the specific type of aircraft on which it would be used.

10. Airlines may offer inflight Wi-Fi between takeoff and landing. The FAA doesn't restrict the use of Skype or other Internet calling software. (Airlines, however, have banned them for the sanity of their crew and passengers.)





Prevention of Air and Gas Ingress

Hermeticity is generally defined as the condition of being air or gas tight. In interconnect applications, it refers to packaging technology designed to prevent gases from passing through pressure barriers via the connector. Hermeticity prevents moisture in the leaked gas from condensing inside the pressurized enclosure. The point at which moisture will condense is called the “dew point”—the precise moment when humidity, pressure, and temperature allows condensation to form.

Hermetic connectors are designed to prevent this from happening. Hermetic connector devices that interconnect the vacuum sealed black box equipment on commercial airliners, for example, are selected for their ability to protect the controlled equipment environment by maintaining an air-tight seal between severe flight conditions and the sensitive payload.

When an electric current must pass through a high-pressure differential barrier, the potential exists for gases, moisture and, in rare cases, particulate matter, to penetrate the barrier and form condensation in the equipment enclosure. In the receptacle cabling on the pressurized side of the barrier this condensation may result in dielectric breakdown, corrosion, and loss of insulation resistance between conductors. The classic hermetic application is a receptacle feed-through penetrating a pressurized bulkhead, or a pressurized equipment housing—such as is found in inertial navigation units in aircraft. The introduction of moisture-laden air into such an enclosure may be enough to produce false readings and other malfunctions in the device. The ultimate purpose of hermetic sealing then is not merely to “avert the ingress of air or gas into pressurized environments to prevent corrosion resulting from dew point condensation,” but more precisely to insure malfunctions do not occur in sensitive electronic systems due to said ingress. Hermetic connectors must perform their magic at extremely high pressure differentials, often as high as 20,000 psi, in order to prevent fluids and high pressure in one area from impacting normal environmental conditions and pressures in another. Hermetic customers are able to select from a broad range of contact densities and package sizes, including standard-density MIL-DTL-38999 Series I, II, III and IV, ultraminiature 0.076 inch contact spacing Series 80 Mighty

Mouse Connectors, and both Micro-D and D-Subminiature rectangulars. And with Glenair’s complete in-house hermetic capability, we can produce a wide-range of special purpose hermetic connectors designed to meet individual and unique customer specifications.

Hermetic connectors are constructed from a core component set that includes the connector shell, the vitreous glass insert and the selected contacts. Matched hermetic shells may be machined from Kovar®, an iron-nickel-cobalt alloy with a coefficient of expansion closely balanced to the glass inserts. Stainless and cold-rolled steels with 52 nickel-alloy contacts are suitable for compression-seal hermetics. Contacts used in hermetic connectors must be fabricated from Kovar® or from other high-grade materials that can withstand high-heat and bond effectively to the vitreous glass seal.

The individual parts are mounted into special fixtures that align them during the exothermic atmosphere firing process. A conveyor belt transports the work through the furnace chamber, where a reducing atmosphere prevents oxidation of the metal components. As discussed above, a gas-tight hermetic seal is formed around all contacts and the glass seal and connector shell when the vitreous glass melts in the furnace and then cools under controlled conditions. After firing, helium testing and finish plating are completed and the remaining connector components such as interfacial seals, O-rings, and so on are assembled to the connector body.





A BRIEF HISTORY OF THE FLYING CAR

The dream and promise of the flying car is more than a century old. Yet we're still not zipping around in them. Our history of audacious attempts shows why building a machine that can fly and drive has proven so difficult.

1917

Renowned aviator Glenn Curtiss, rival of the Wright Brothers and a founder of the U.S. aircraft industry, could also be called the father of the flying car. In 1917, he unveiled the Curtiss Autoplane at New York's Pan-American Aeronautic Exposition. It featured an aluminum Model T Ford-like body, four wheels, a 40-foot wingspan, and a giant 4-blade propeller mounted in the back, but only managed a few hops.



1935

Frank Skroback, a retired industrial technician and electrician from Syracuse, studied the concepts of French furniture-maker-turned-aircraft designer Henri Mignet, and modified his tandem wing monoplane design into a multi-purpose, 6-wing, 21 foot long Flying Car.



1947

Henry Dreyfuss's combined a fiberglass automobile body with a wing-and-propeller module to create the ConvAirCar. Unfortunately, it crashed during a test flight, killing its operator... and its chances for mass production.



1953

Leland Bryan of Buick flew his Autoplane, which used a rear propeller for driving and flying. Bryan died in 1974 when he crashed an Autoplane at an air show.

1973

Aerospace engineer Henry Smolinski unveils the AVE Mizar "Flying Pinto." The back half of a Cessna Skymaster is mated with a Ford Pinto. The car engine is used for surface travel and runway boost on takeoff. In flight, the craft depends on Skymaster wings, a twin-boom tail and pusher propeller. The flight equipment is detachable to allow street travel. Smolinski and pilot Harold Blake die when a wing folds in a test-flight crash.



1989

Aeronautics engineer and inventor Paul Moller has been working to bring a flying vehicle to the mass market for four decades. In 1989 he launched the M200X prototype, now known as the Moller M200G Volantor. It can go 100 mph over a 900 mile range on 8 low-emissions Wankel engines that run on a bioethanol/water mixture. This special blend reduces fire hazards and cools the engines from within. It also fulfills California SULEV emissions requirements!



2009

Steve Saint, son of the 20th century martyr Nate Saint, is awarded *Popular Mechanics'* Breakthrough Award for the Maverick, a flying dune buggy he invented to deliver missionaries with supplies, medical care, and the Gospel to remote areas. In unreachable parts of the world where roads are nonexistent, the Maverick's short take off and ability to fly *and* float, help it make roads out of the natural terrain.

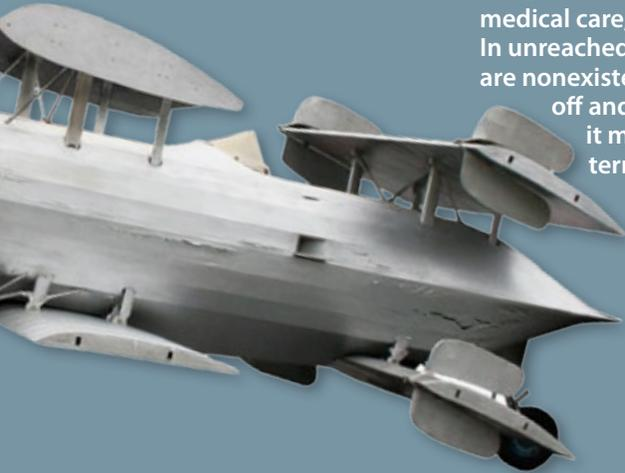

2012

Terrafugia Corporation's Transition "street legal" production prototype completed its first flight, and several phases of testing. The one-pilot, one passenger vehicle can go 70 mph on the road—and it can fit in the garage with its wings folded. In flight, the pusher propellor can attain a cruising speed of 107 mph. Equipment includes a Dynon Skyview glass panel avionics system, an airframe parachute, and an optional autopilot.



2015 (?)

The DARPA TX Transformer is a proposed flying car for the U.S. Military. The objective of the Transformer program is to demonstrate a four person vehicle that provides enhanced logistics and mobility though hybrid flyable/roadable capabilities. This presents unprecedented capability to avoid traditional and asymmetrical threats while avoiding road obstructions.



Leadership

At Glenair, we tend to think carefully about big issues such as “Leadership,” both within our own organization and within our industry. Truly effective leadership can only occur in an environment based on total trust. Yet, we’re always amazed that so many organizations miss this key prerequisite.



Imagine we bring home a puppy. Our goal is to wind up with an engaged, contributing member of our household. But the first night, the poor thing sits quaking in the corner. How do we solve this problem? We create an environment of total trust by being kind, soft, and caring to create reassurance and security. We communicate well. We share our water and food. Above all, we’re consistent in our behavior. And, in due course, the puppy trots over and sits down by our side; the start of loyal friendship.

Yet, how do leaders in many organizations behave when they “bring home” a new employee or supplier? Are they kind, soft, and caring to create reassurance and security? Do they communicate well? Do they share their water and food? Are they consistent? Hardly! Instead, they “smack them with a rolled up newspaper” creating an environment of zero trust. And these leaders remain perplexed as to why suppliers and employees “quake in the corner” whenever they happen by.

Humans crave good leaders—whether in households, sports teams, businesses, societies or countries—who, like Atticus Finch in *To Kill A Mockingbird*, are trustworthy, strong, courageous, fair, loyal, sharing, and have a “winning” track record. Humans also know instinctively what constitutes a bad leader. Bad leaders are dishonest, two-faced, cowardly, selfish, and disloyal. To cite another film, what kind of leader was the Wicked Witch in *The Wizard of Oz*? Remember when Dorothy melted her, and the Winkies and flying monkeys all cheered? People not only try to avoid bad leaders, if stuck with one, we do our best to “do them in.” It’s really quite simple: given a choice, we will seek out good leaders and avoid bad ones.

The best leaders recognize “how the world really works” and align their behavior with it, seeking always to be trustworthy, strong, courageous, fair, loyal, sharing, and “winning.” They are never dishonest, two-faced, cowardly, selfish, or disloyal. Thankfully, our culture here at Glenair makes it easy to be a good leader. And while we appreciate our customers, suppliers and employees for their ongoing loyalty, we don’t take it for granted, and plan to keep earning it with good leadership and an atmosphere of total trust.

Chris Toomey

Publisher

Christopher J. Toomey

Executive Editor

Marcus Kaufman

Managing Editor

Carl Foote

Editor/Art Director

Mike Borgsdorf

Graphic Designer

George Ramirez

Technical Consultant

Jim Donaldson

Issue Contributors

Deniz Armani
Greg Brown
Greg Cameron
Stewart Clark
Russell Ghiselli
Joseph Hsiung
Guido Hunziker
Christian Koppe
Tom LeMenager
Ron Logan
Mike MacBrair
Jim Plessas
Ramzi Sawires
Mike Wofford

Distribution

Terry White

QwikConnect is published quarterly by Glenair, Inc. and printed in the U.S.A. All rights reserved. © Copyright 2013 Glenair, Inc. A complete archive of past issues of QwikConnect is available on the Internet at www.glenair.com/qwikconnect

GLENAIR, INC.

1211 AIR WAY
GLENDALE, CA 91201-2497
TEL: 818-247-6000
FAX: 818-500-9912
E-MAIL: sales@glenair.com
www.glenair.com

