

QwikConnect

GLENAIR ■ OCTOBER 2013 ■ VOLUME 17 ■ NUMBER 4



Rectangular Connector

LOLLAPALOOZA

ARINC 600 FILTERS • SERIES 20 SUPER-TWIN
MWDM MICRO-D • SERIES 89 NANOMINIATURE
SERIES 79 MICRO-CRIMP • SERIES 28 HIPER-D
SERIES 171 ALPHALINK SL



Rectangular Connector LOLLAPALOOZA



Separable interconnect devices are key components in every electrical, optical and electronic system. Connector families are organized according to shape: circular or rectangular. Both types bring connector halves together in a reliable and repeatable manner—with locking mechanisms to ensure connectors stay mated during use. Historically, rectangular connectors were used in rack-and-panel applications, for example to plug and unplug instrumentation and military gear from racks that contained a common bus bar. The term “rack-and-panel” is now used more broadly to describe all connectors employed in cable-to-chassis, cable-to-cable and/or cable-to-rack (cabinet) connections. Typical rectangular connector applications run the gamut from blind-mate scenarios with connectors mounted in equipment racks, drawers and trays to simpler cable to box applications, manually mated and secured with jacking hardware.

Unlike most circular connectors in which the potential for mis-mating of plugs and receptacles is managed with keyway patterns, rectangular connectors generally manage this requirement with the physical

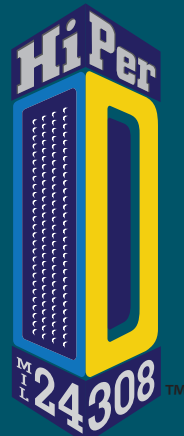

shape of the shell—typically with a “D” shaped metal shield with or without keys. Rectangulars that employ this shape include the D-subminiature (although these days it’s hardly considered a miniature connector, let alone a subminiature), the Micro-D and the Nano. These progressively smaller I/O and board-level connectors (see below) are rated electrically and mechanically by current carrying capacity, contact density and DWV. While D-subminiature connectors are common on everything from network ports and gaming consoles to video output devices, they are also common in higher performance military and aerospace applications including space-rated applications. Their smaller Micro-D and Nanominiature cousins are applied in high-reliability settings such as missile systems.

The termination of contacts and wires in rectangular connectors includes all popular methods—from solder cup and PC tail fixed contacts to crimp and poke variations. Let’s take a look at the common types in a little more detail, starting with the largest and working our way down.

ARINC 404 and 600 Connectors

The largest rectangular connector family the ARINC 404 and 600, takes its name from Aeronautical Radio, Inc., an airline industry association active in specifying connectors for use in commercial aircraft. The ARINC connector family features

Combo D-subminiature M24308 connectors are ideally suited for use in analog signal, power, and RF applications. Glenair HiPer-D connectors with combo layouts deliver both the flexibility and convenience of mixed size #8 and size #20 contact arrangements, as well as the high performance attributes of this ruggedized, environmental version of the M24308. Over 20 combo insert arrangements are available, including native size #8 as well as mixed size #8 and size #20. Crimp contact and PC board terminations are available with both standard and low profile shells. Designed for use in power controllers, radar systems, video applications and other military and aerospace electronic equipment, all HiPer-D combo arrangements are tooled and ready for immediate application.

aerospace-grade construction and is designed with seals against moisture for use in high-reliability applications. The original environmental resistant version, the ARINC 404 series, was geared for use by the commercial aircraft industry. The military produced its own version under specification

MIL-C-81659. Later, the ARINC 600 series was developed—again for the commercial aircraft industry—as a significant upgrade to the ARINC 404. ARINC 600 offers low mating force contacts, and up to 800 size 22 contact positions in one connector. Larger power contacts are also supported as well as shielded contact up to size #8.



Radiall EPX® Connectors

Various forms of high-density, modular connectors were first popularized by Radiall in the form of this rack-and-panel series. The connector was designed around modular inserts of set size and dimension that are housed in connector shells providing application-specific functionality such as polarization, central jackpost attachment, blind-mating and so on. Drop-in modules provide ease of configuration for changing electrical, signal and data requirements.

The Glenair series 20 Super-Twin™ lightweight modular connector is an innovative replacement for legacy cable and panel connectors of this type that may no longer meet changing performance specifications—especially for ease of assembly, electromagnetic compatibility and size, weight and power optimization. The Glenair Series 20 Super-Twin™ can accommodate a broad range of contact sizes and types

from #23 to #8 signal, Quadrax, power, and fiber. Modular inserts offer fast and flexible assembly and repair. Peripheral and grommet seals provide outstanding environmental protection. Keyed inserts and shells provide versatile polarization and protection against mis-mating. The innovative clamshell and banding porch design brings modern, state-of-the-art connector capabilities to modular cable and panel applications. You can learn more about Super-Twin later in this special rectangular issue of QwikConnect.



MIL-DTL-24308

By far the most common of all rectangular connectors, the MIL-DTL-24308 D-Subminiature connector, with its distinctive D-shape mating interface, is well suited for its role as a general purpose power and signal interconnect—for example for the low and medium speed serial data communications required by personal computers. Adapted from military connectors first offered in the 1950s, D-subminiature pin and socket connectors are typically supplied with crimp removable contacts with rear insertion and removal. The MIL-DTL-24308 specification defines D-subminiature dimensions, construction, materials and performance to ensure universal compatibility and intermateability amongst the dozens of military and commercial suppliers. Special versions of the D-sub, for coaxial, high-voltage, and high-current contacts are available. High-performance environmental, space-grade, hermetic and filter class versions are used in airframe applications and elsewhere when standard-performance products will not serve. D-subminiature connectors are generally considered to



ARINC 600



M24308 intermateable



Series 20 Modular Rack-and-Panel



Series 79 Ultraminiature

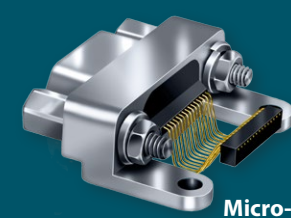

Micro-D



Nano-D



Board-level AlphaLink

HIPER-D VS. ARINC 600

Smaller, lighter HiPer-Ds with robust EMI/grounding performance save weight, and reduce assembly time and complexity compared to conventional ARINC backplane/motherboard configurations.

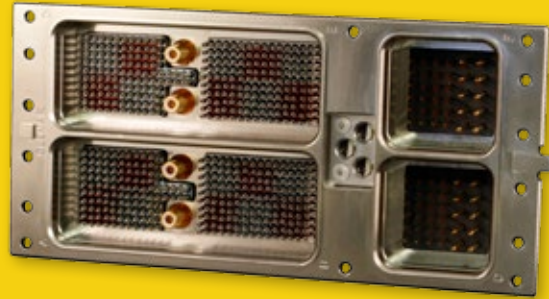

Legacy ARINC 600 type solutions are no longer optimized for the size and weight reduction requirements of today's aircraft industry.



The opportunity to replace big, bulky and expensive ARINC 600 type rack-and-panel connectors with a distributed architecture utilizing discrete D-subminiature connectors is finally realized with the high-performance Glenair HiPer-D. With the outstanding performance of the HiPer-D, system designers are now able to optimize available space in equipment consoles and boxes without compromising EMC or temperature tolerances. Distributed interconnect architectures of this type also allow for easier troubleshooting, and the ability to eliminate expensive motherboards and of course, cumbersome rack-and-panel ARINC connectors. The ability to separate out intrinsically safe functions—for example segregating power circuits completely from signal circuits—allows designers to build handier systems which are easier to assemble and maintain.



HiPer-D contacts: size #22 and #20 signal; size #8 power and coax; and special low-insertion-force hyperboloid.

be non-environmental solutions suitable for -55°C to +125°C applications. Despite their relatively large contact-to-contact density (by today's standards) the D-sub is perfectly suited for applications in which attention to space and weight is a requirement as they are able to accommodate large numbers of contacts in a relatively dense package. This makes the D-sub well suited for everything from missile systems to satellites, aircraft avionics and ground support platforms. Glenair Series 28 is a high-performance M24308 D-sub.

Series 79 Micro-Crimp

In applications where even the most advanced D-Sub available cannot meet required environmental and electromagnetic compatibility benchmarks, Glenair has invented a rectangular crimp-contact version of our circular Mighty Mouse interconnect. The Micro-Crimp connector features crimp, rear-release size #23 contacts on .075 inch (1.9 mm) spacing, as well as size #12 and #16 power and coaxial crimp contacts in a range of hybrid layouts. Available in 31 insert arrangements, the Micro-Crimp provides a wide selection of arrangements for data and power transmission.

Today's defense/aerospace systems require advanced levels of environmental protection, electromagnetic shielding and size/weight reduction. The Series 79 was developed to meet these needs. Panel mounted connectors feature conductive sealing gaskets. Right-angle printed circuit board connectors have an EMI shroud to prevent electromagnetic interference. Wire sealing grommets and interfacial seals protect circuits from moisture and contamination. Series 79 plugs are available with auxiliary EMI springs for superior EMC performance.

MIL-DTL-83513 (MWDM) Micro-D Connectors

Continuing the evolution to ever smaller packaging and higher contact density, we turn now to the MIL-DTL-83513 Micro-D (Glenair MWDM Series). The Micro-D is a high-density, precision machined rectangular with contacts set on .050 inch centers, typically supplied with fixed solder cup or PC tail contacts or pre-wired with a pigtail or flex. Every element of the MIL-DTL-83513 Micro-D is exactly controlled—from terminal spacing to approved wire termination methods. The military standard defines contact resistance, dielectric withstanding voltage, corrosion resistance, shock and vibration tolerances and a wide range of other electrical, mechanical and environmental performance standards. Standardized measurement and test methodologies ensure consistent, predictable performance throughout this broad family of ruggedized, miniature connectors.

For applications where interconnect failure is simply not an option, the Glenair high-reliability Micro-D offers a wealth of performance benefits which far outweigh any potential cost savings realized by specifying a lesser caliber

connector. If downtime is a critical concern, other connectors cannot match the long-term durability and performance advantages of the MIL-DTL-83513 Micro-D, which include:

- Higher current ratings
- Lower circuit resistance
- Superior vibration and shock
- Optimized EMI/RFI shielding
- Broader operating temperature
- Better damage resistance
- Enhanced corrosion resistance
- Better contact retention
- Better environmental sealing

Nanominiature

Nanominiature connectors, with their 1 AMP contacts set on .025 inch centers, are the smallest and lightest mil-spec connector in the business. These MIL-DTL-32139 qualified connectors for mission-critical board-to-wire applications offer superior mating and unmating performance and environmental resistance. TwistPin equipped Nanominiature connectors are precision machined from aluminum, titanium or stainless steel. Designed to accommodate size #30 and #32 gauge wire, both rectangular and circular versions are available in prewired pigtail or printed circuit board configurations.

WHY RECTANGULAR?

Circular connectors are ideally suited for applications that require efficient, manual mating and de-mating of connectors. Circulars are also considered superior in terms of their environmental performance. But rectangular-shaped connectors have many advantages of their own. Here are the main reasons rectangulars are king in so many interconnect applications:

Connector/Contact Density

Because of their shape, and the way rectangular connectors are fixed together with jacking hardware, these connectors can deliver optimized interconnection of circuits with higher-density and less wasted space compared to circulars. The illustration above depicts four, 102 contact Series 79 Micro-Crimp connectors versus four 130 contact Series 80 Mighty Mouse connectors—in the highest contact counts currently available in each series. If you simply do the math, it may appear Mighty Mouse is the contact density winner. But considering the stackable Micro-Crimp does its job in 1/3 the space as the Mighty Mouse, the rectangular shaped solution comes out on top.

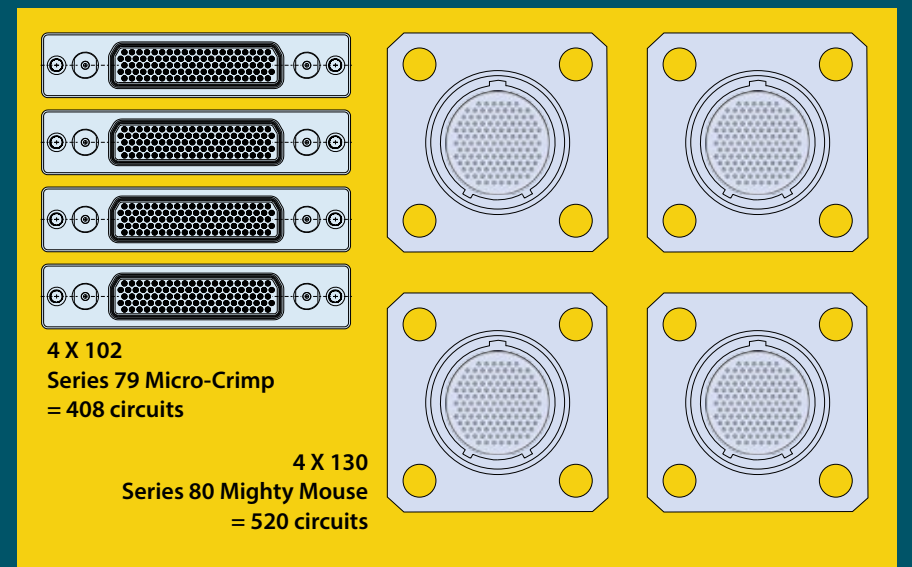

Space Constraints

Efficient use of space goes hand in hand with contact density to enable rectangular shaped connectors to better fit into reduced-space applications. Because of their overall shorter length, lower shell profile and the fact that rectangulars do not need as much adjacent space for manual mating and de-mating, they are the connector of choice for low profile devices such as backplane and blade-type applications.

Blind Mate and Rack Applications

Rectangular connectors may be easily fitted with float mount and guide-pin technologies, making them suitable for blind-mate and rack applications. While there are certainly situations in which a circular blind-mate connector is the preferred solution, rectangular blind-mate connectors are the ideal choice for use in trays, connectorized equipment racks and equipment consoles.

Right Angle Board Accommodation

High contact count—even multi-row—rectangular connectors provide for a much simpler pathway for right angle PC board termination compared to circular connectors. In circular packages, each additional row increases complexity and requires additional touch labor, testing, and component configurations.

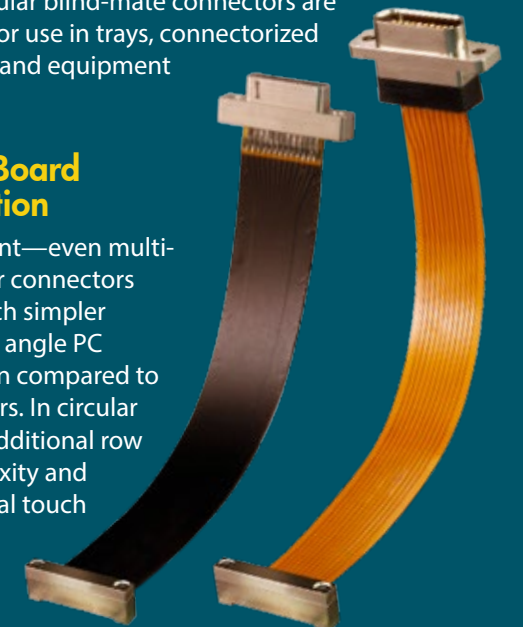



SERIES 171

AlphaLink SL

Board-level spring-loaded-contact connectors and turnkey flex jumpers

AlphaLink SL is a high-performance, solderless board-level connector technology developed by Glenair that significantly expands board-level interconnection options for users of mil-spec caliber connectors. Precision-machined and EMI shielded, these ultra lightweight PC tail, solder cup, and/or pigtail equipped connectors are designed for high-reliability applications that require avionic system levels of vibration and shock tolerance. Ultra low-profile and high-density, AlphaLink SL connectors are equipped with 2–3 Amp spring-loaded contacts and may be ordered either as discrete connectors or in turnkey flex jumpers that combine popular Glenair high-reliability I/O connectors. Glenair is perfectly positioned to provide the entire solution with in-house manufacturing for every component part—from connectors and contacts to rugged polyimide-based flex. AlphaLink SL flex jumpers are available with Series 80 Mighty Mouse and Series 88 SuperFly ultraminiature and nanominiature circular connectors, as well as Micro-D subminiature, Series 79 Micro-Crimp, and nanominiature rectangular connectors. A wide range of insert arrangements, from 4–40 contacts is available.

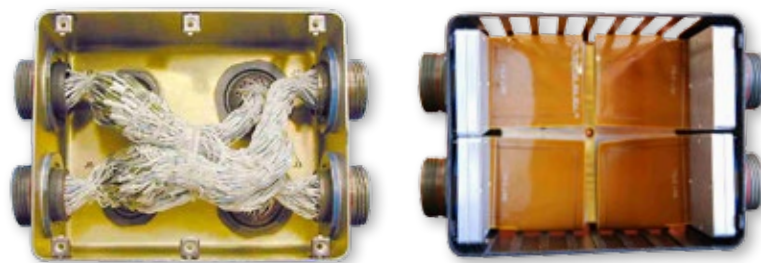

Flex offers many advantages over conventional wire, including reduced size, weight, and complexity.

- **Spring-loaded, solderless board-level connector**
- **PC tail and solder cup versions offer easy termination to flex or wire**
- **Turnkey I/O-to-board flex and pigtail wire jumpers**
- **Lightweight and low-profile—up to 40% space savings compared to 2mm pitch solutions**
- **High-density .050" center-to-center contact footprint**
- **Fast PC board integration with reduced board preparation and masking**
- **Withstands temperature, vibration and shock extremes**

SERIES 171 ALPHALINK SL Spring-loaded contact board level connector Fast and easy PC board integration



New!
AlphaLink SL
board-level
spring-loaded
contact pre-
wired pigtail
assemblies

AlphaLink SL Spring-Loaded Contact Interface

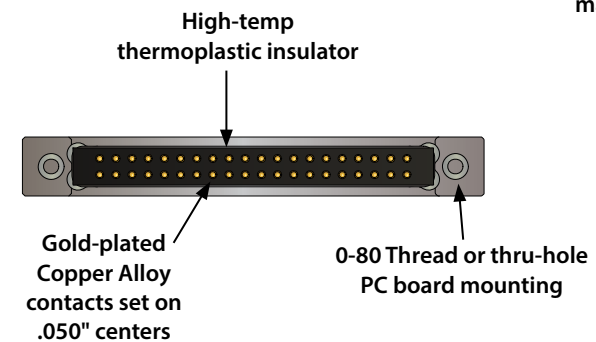

171-134-01 Solder Cup Termination

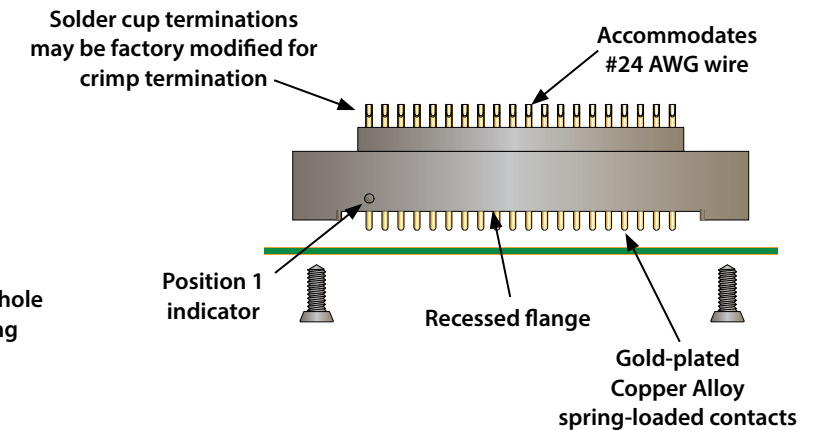

171-134-03 Wire Pigtail Termination

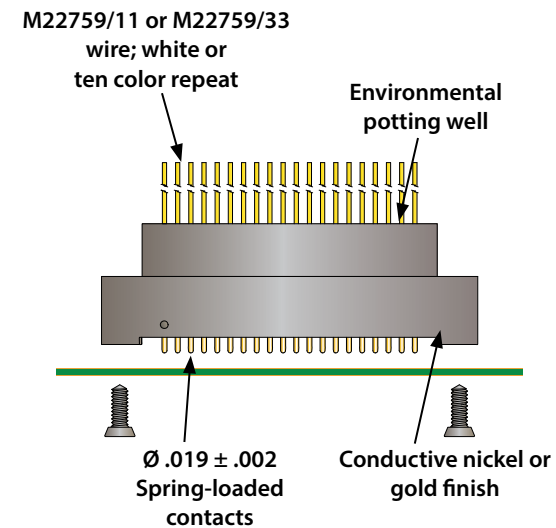

171-134-02 PC Tail Termination

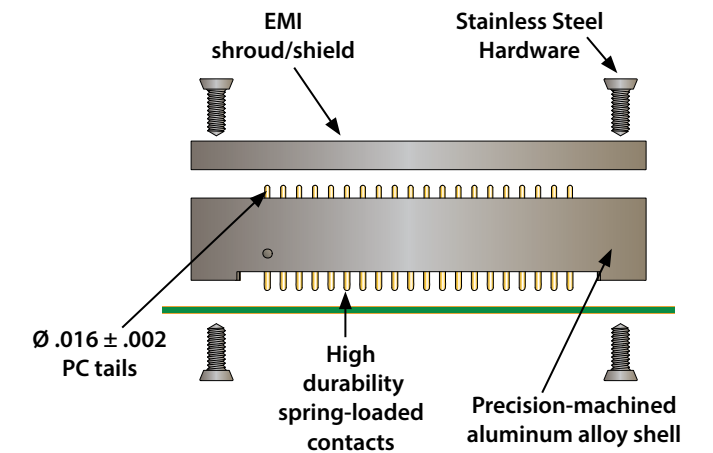

AlphaLink SL flex jumpers: Compact interconnect assemblies that combine circuit board technology and cabling into a lightweight, integrated package. These turnkey jumper assemblies reduce system size and weight and are ideally suited for prototype applications and new product development efforts.

AlphaLink SL spring-loaded contact PC board connectors deliver up to 50% footprint savings versus conventional 2mm pitch solutions. PC tail equipped connectors, the 171-134-02, are supplied with an EMI shroud / shield for improved EMC compared to low-cost plastic board connectors. All connector styles incorporate a high-reliability spring-loaded contact that delivers a virtually unlimited number of mating cycles. Connectors are typically mated to the PC board using conductive pads or vias. Stainless steel mounting hardware provides a robust, vibration-resistant attachment solution compared to stamped-and-formed retention bars.

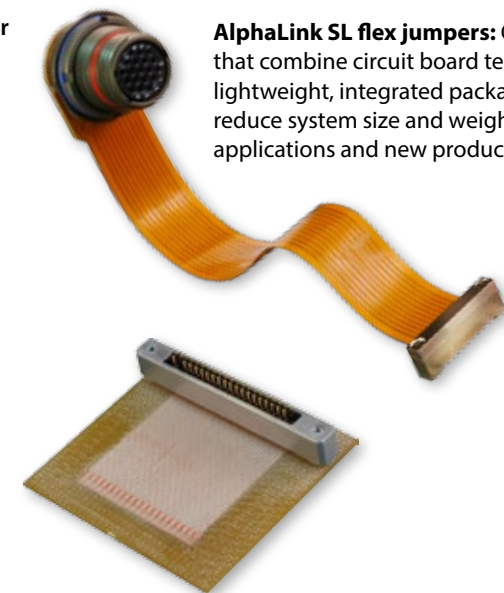

For more information
contact Glenair at
818-247-6000 or
visit our website at
www.glenair.com
U.S. CAGE code 06324

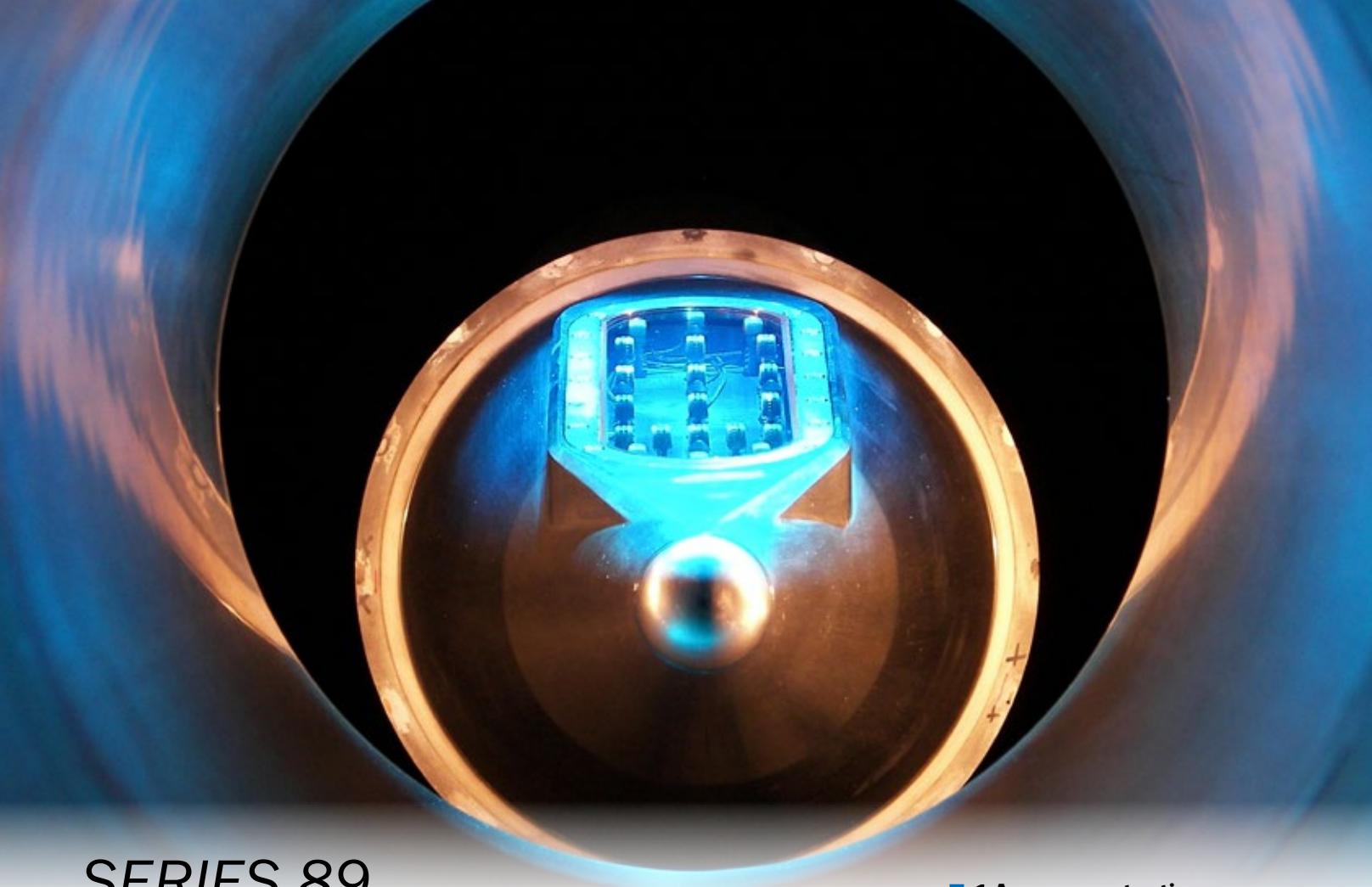

SERIES 89
Nanominiature Connectors



The smallest and lightest mil-spec connector

SERIES 89
Nanominiature
Connectors



MIL-DTL-32139 qualified connectors for mission-critical board-to-wire applications— simply the smallest and lightest mil-spec connector in the business

- 1 Amp current rating
- .025 Inch (0.64 mm) contact spacing
- #30 And #32 gage wire accommodation
- Single and double row
- Metal shell, aluminum, titanium or stainless steel
- TwistPin contact system
- Gold alloy contact, unplated
- Thru-hole and surface-mount PCB versions

THE NANO TWISTPIN ADVANTAGE

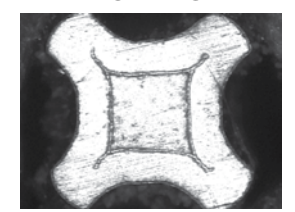

Transverse cross-section of a TwistPin contact crimped to solid wire

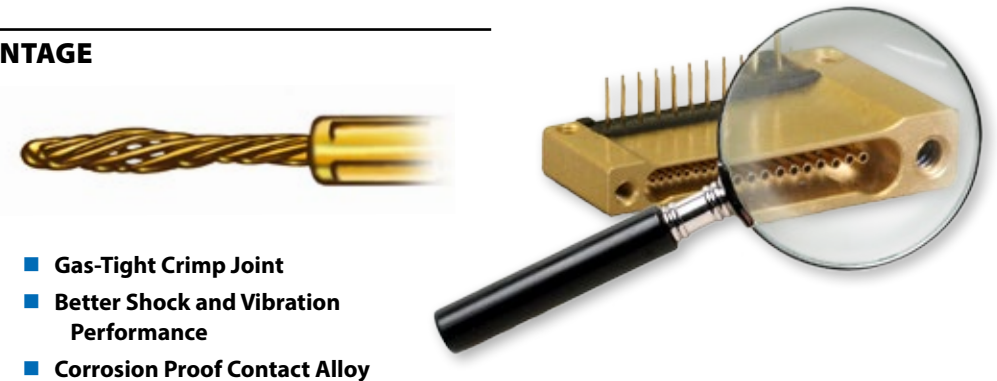

- Gas-Tight Crimp Joint
- Better Shock and Vibration Performance
- Corrosion Proof Contact Alloy

Series 89 Nanominiature Connector Performance Summary	
Contact Spacing	.025" (0.64mm) Contact Centers
Wire Accommodation	#30-#32 AWG
Current Rating	1 AMP Max
DWV	250 VAC RMS Sea Level
Insulation Resistance	5000 Megohms Minimum
Operating Temperature	-55° C. to +125° C.
Contact Resistance	71 Millivolt Drop Maximum
Shock, Vibration	100g's, 20 g's
Durability	200 Mating Cycles
Corrosion Resistance	48 Hours Salt Spray
Mating Force	5 Ounce Max, 0.4 Ounce Min

Glenair nanominiature connectors are MIL-DTL-32139 qualified. Series 89 products offer options not covered in the mil-spec.

How Small Are They?

D-Subminiature Connector
25 Contacts
on 0.109 Inch Spacing

Micro-D Connector
25 Contacts
on 0.050 Inch Spacing

Nano Connector
25 Contacts
on 0.025 Inch Spacing

Series 89 Nanominiature Product Selection Guide

Pre-Wired Single Row Connectors	Insulated Wire	Uninsulated Wire	Back-to-Back Cables		
Pre-Wired PCB Connectors	Thru-Hole Vertical	Thru-Hole 90°	SMT Vertical	SMT 90°	
Pre-Wired Double Row Connectors	Insulated Wire	Uninsulated Wire	Back-to-Back Cables		
Double Row PCB Connectors	Thru-Hole Vertical	Thru-Hole 90°	SMT Vertical	SMT 90°	SMT Straddler
Pre-Wired MIL-DTL-32139 Connectors	Single Row, Insulated Wire	Double Row, Insulated Wire			

NANOMINIATURE CONTACT ARRANGEMENTS

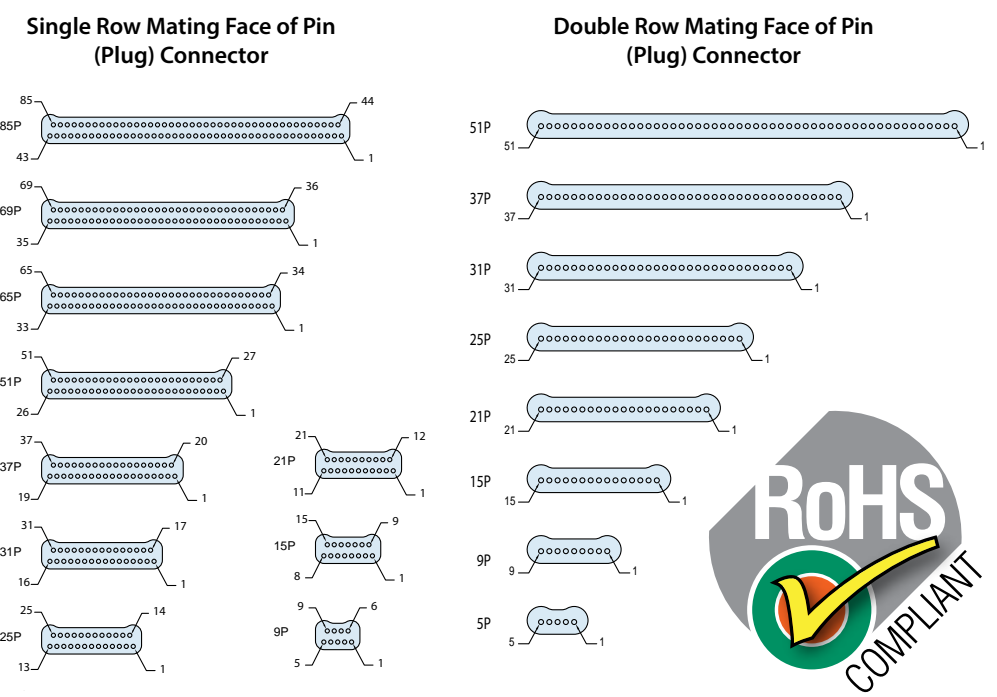



SERIES MWDM

Micro-D Connectors

High-performance Micro TwistPin contacts

- High density Micro TwistPin contacts set on .050 centers
- 9 to 130 contact arrangements
- Pigtail, PCB, solder cup, and flex terminations
- Single row, multi-row, low profile and high density insert arrangements
- QPL and commercial versions
- Same-day availability on all part numbers



Standard



Hermetic



EMI Filter

TwistPin equipped MIL-DTL-83513 Micro-D connectors offer outstanding mating performance, durability and minimal contact resistance

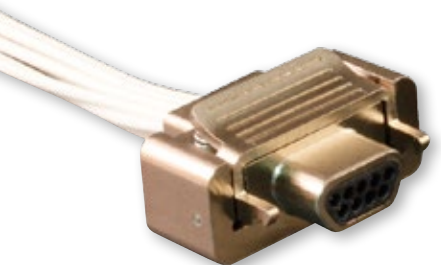

MasterLatch™



Surface Mount



Rear Panel Mount



Flex Circuit

MIL-DTL-83513 AND COMMERCIAL
Micro-D Connectors
Mission-critical mating performance



Metal Shell Micro-D for Harnessing Applications					
GRPM Solder Cup	GRPM Insulated Wire	GRPM Uninsulated Wire	MWDM Solder Cup	MWDM Insulated Wire	MWDM Back-To-Backs
Shielded Cable Assembly	MWDM Uninsulated Wire	GMDR Insulated Wire	GMDE Environmental	GSWM SpaceWire	GMLM MasterLatch

Micro-Ds for Printed Circuit Board			
GRPM-CBS	GRPM-CBR	MWDM-BS	MWDM-BR
MWDM-CBR	MWDM-CBS	90° Surface Mount	GMR7580
GMR7590	GMR7580C	GMR7590C	Right Angle Filter

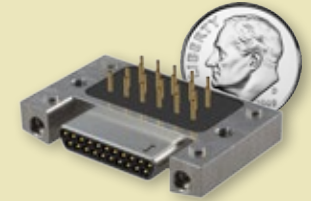

WellMaster™ 260

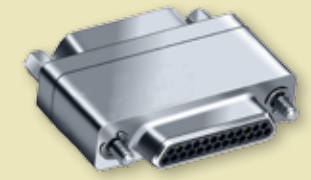

Sav-Con®

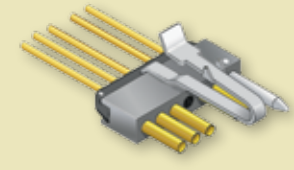

Latching MicroStrip

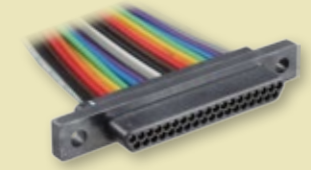

Low Profile

BRAINTEASERS

ECNALG

1,3,5,7,9 R
whelming

loallisve
wafairr

SK3.14159Y

1, 2, 3, 4...

Thought

Funny Funny
words words
words words

HOROBOD
NE1 4 10S?

duobles
duboles
doulebs

CtOaMxE
stefrankin

MACBETH
WORDS

thoudeepght cheek / keehc

give
give
give
give
get
get
get
get

m__ce MIYLIIIFIE
m__ce LadyLadyLady
m__ce

LOOKYORSETE

spring
summEr
autumN
winTer

A
MAT

abcdef
ghijk
mnopq
rstuvw
xyz

chtongueeek

STANDS

0_23456789

Revird Taes

SAILING
CCCCCCC

phromate

HiOiWiEiR

To_uch

Cut

↓
EGDOESGS
THE END

KNEE
LIGHTS

← EZ

amUous

accaughtt

Cut, Cut, Cut
Cut, Cut, Cut

EZ →

EVARELTO 0

wa y, wei gh,
w hey

M.D
Ph.D
BSc

Dumps Dumps
Goosefeathers
Dumps Dumps

do12"or diet
wowlfol ▲
831SAFETY964

weight

COORDERURT

ANSWERS: www.glenair.com/qwikconnect
(available November 15th)



SERIES 79

Micro-Crimp

The ultraminiature crimp contact rectangular with advanced environmental and EMC performance

- Crimp, PCB, fiber optic, coax, power and pitot
- Precision machined aluminum shells sealed to IP67
- High-density #23 contact arrangements set on .076 centers
- Blind mating for rack and panel applications
- Over 30 tooled contact arrangements
- Integrated ground spring for improved EMI shielding

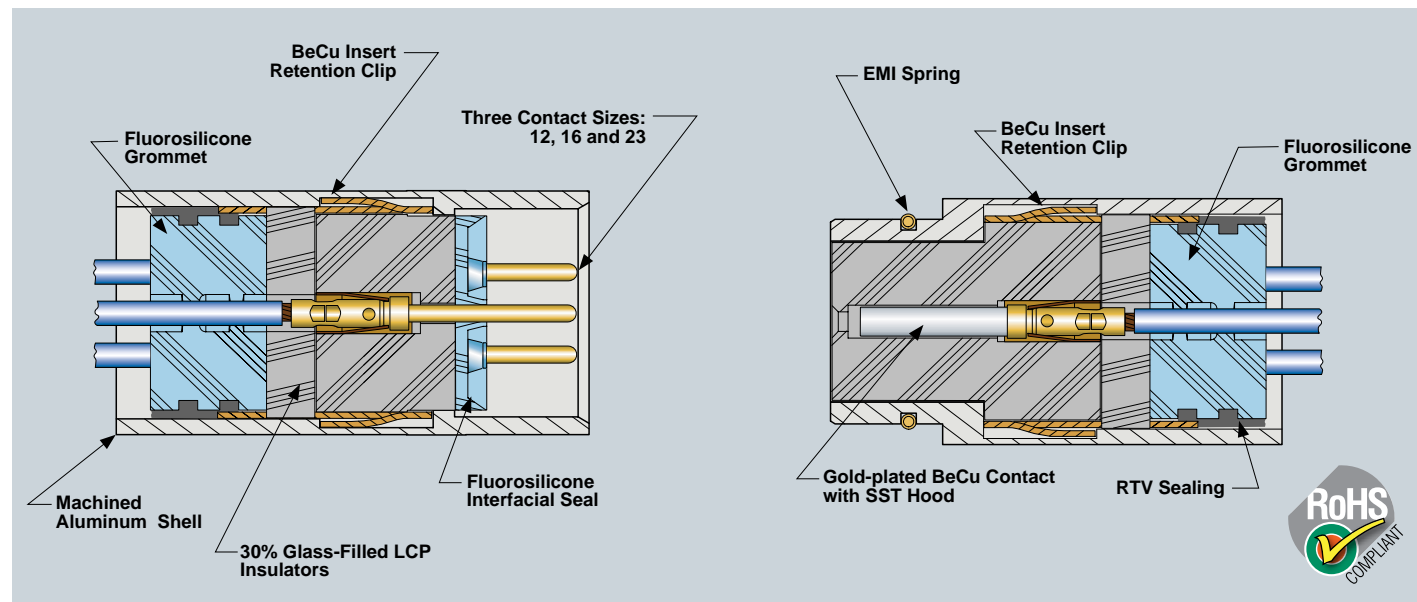

SERIES 79 Micro-Crimp High-reliability crimp contact performance



SERIES 79 MICRO-CRIMP PRODUCT SELECTION GUIDE

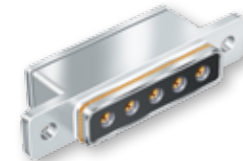

Crimp Terminated Cable Connectors

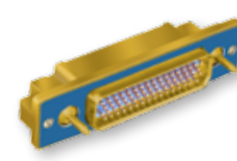

Crimp Terminated Panel Mount Connectors



Straight PCB Panel Mount and Free-Standing Connectors



Right Angle PCB Panel Mount and Free-Standing Connectors



Backshells and Accessories, EMI Adapters and Protective Covers

Blind Mate Guide Pins and Sockets

Guide Pins
Connector may be supplied with stainless steel non-removable guide pins.

Guide Sockets
Connector may be supplied with stainless steel non-removable bushings.

Selected Contact Types

Standard Signal

Power

Coaxial

Differential Twinax

Fiber Optic

Pitot Tube

Shell Size	Contact Arrangement	Contact Quantity		
		#23	#16	#12
A	A-5	5	—	—
B	B-2P2	—	2	—
	B-9	9	—	—
C	C-13	13	—	—
D	D-15	15	—	—
	D-3P3	—	3	—
	D-7P2	5	2	—
E	E-11P2	9	2	—
	E-19	19	—	—
	E-7P3	4	3	—

Shell Size	Contact Arrangement	Contact Quantity		
		#23	#16	#12
F	F-15P2	13	2	—
	F-23	23	—	—
	F-5P5	—	5	—
G	G-33	33	—	—
H	H-10P4	6	—	4
	H-29P7	22	7	—
	H-36P2	34	—	2
	H-54P2	52	2	—
	H-5P5	—	—	5
	H-66	66	—	—

Shell Size	Contact Arrangement	Contact Quantity		
		#23	#16	#12
J	J-17P4	13	4	—
	J-25P2	23	2	—
	J-33	33	—	—
	J-7P7	—	7	—
K	K-27P4	23	4	—
	K-35P2	33	2	—
	K-43	43	—	—
	K-9P9	—	9	—
L	L-6P6	—	—	6
	L-78	78	—	—
M	M-102	102	—	—

Performance Specifications	
Current rating	Contact size #23 5 Amps, size #16 13 Amps, size #12 23 Amps maximum
Voltage rating (DWV)	Contact size #23 500 VAC rms. size #16 and #12 1800 VAC rms. Sea level.
Insulation resistance	5000 megohms minimum
Operating temperature	-65° C. to +150° C.
Contact resistance	5 milliohms maximum
Water ingress protection	IP67
Shielding effectiveness	>75 dB attenuation from 100 MHz to 1000MHz, >60dB 1GHz to 4GHz, >40dB 4GHz to 10GHz.

For more information contact Glenair at 818-247-6000 or visit our website at www.glenair.com
U.S. CAGE code 06324



SERIES 20

SuperTwin™

Lightweight Composite Modular Connectors

Drop-in replacements for legacy modular rectangular connectors save weight, space, and assembly time

Today's high-performance commercial aircraft are looking for revolutionary materials and product designs that can reduce weight and improve reliability and performance. The Glenair Series 20 Super-Twin™ lightweight modular connector is a drop-in replacement for legacy cable and panel connectors that no longer meet these performance specifications—especially for ease of assembly, electromagnetic compatibility and size, weight and power optimization.

The Glenair Series 20 Super-Twin™ can accommodate a broad range of contact sizes and types from #23 to #8 signal, Quadrax, El Ochito®, power, and fiber. Modular inserts offer fast and flexible assembly and repair. Peripheral and grommet seals provide outstanding environmental protection. Keyed inserts and shells provide versatile polarization and protection against mis-mating. The innovative clamshell and banding porch design brings modern, state-of-the-art connector capabilities to modular cable and panel applications.



- For reduced size and weight cable and panel applications
- Lightweight composite shell with integral strain relief/banding porch
- Modular inserts support a wide range of contact sizes and types up to #8
- Polarization – both shell and inserts
- Center jackscrew with self-locking hardware



For more information contact Glenair at 818-247-6000 or visit our website at www.glenair.com U.S. CAGE code 06324

SERIES 20 Super-Twin™ Lightweight Composite Modular Connectors



SUPER-TWIN™ SHELLS AND INSERTS ARE ORDERED SEPARATELY

How To Order - Shells						
Sample Part Number	200-013	P	2	-XM	31	K
Series 20 Modular Connector	200-013 Plug Shell 200-014 Receptacle Shell					
Plug/Receptacle	P = Plug Shell, R = Receptacle Shell					
Size	Size 2					
Finish	XM = Electroless Nickel XB = No plating, black					
Polarization Code	2 digits: First digit 1 – 4 (factory installed) Second digit 1 – 4 (factory installed) Blank = keys supplied as kit					
MicroBand Option	K = MicroBand supplied. Blank = no MicroBand					

How To Order - Inserts						
Sample Part Number	200-005	P	2	-60	A	
Series 20 Modular Connector	200-005 Pin Insert 200-006 Socket Insert					
Pin/Socket Insert	P = Pin Insert, S = Socket Insert					
Size	Size 2					
Insert Pattern	60 = 60X #23 contacts					
Polarization	A, B, C, D, E, F, G, H (must match with shell polarization)					

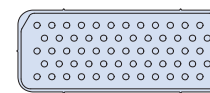

PATTERN 60
60 X Size 23 Contacts
DWV= 750 VAC

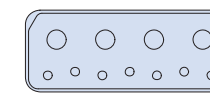

PATTERN 7W4
4 X Size 12 Contacts
7 X Size 20 Contacts
DWV= 1500 VAC

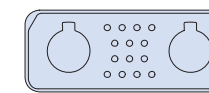

PATTERN 14Q2
2 X Size 8 Contacts
14 X Size 23 Contacts
DWV= 750 VAC

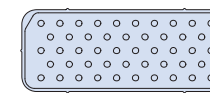

PATTERN 48
48 X Size 23 Contacts
DWV= 1300 VAC
DWV@50 000 ft = 800 VAC

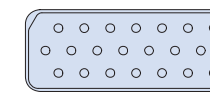

PATTERN 21
21 X Size 20 Contacts
DWV= 1500 VAC

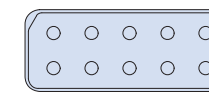

PATTERN 10
10x Size 16 Contacts
DWV= 1500 VAC



Modular inserts easily removed with available tool

Keyed, snap-in-place insert modules are currently available in six tooled layouts, accommodating size #23, #20, #16, #12 and keyed size #8 contacts (for use with Quadrax or El Ochito™ contacts).



Weight Study, Typical Regional Jet Airframe

Series 20 SuperTwin™
Mated Pair: 67g
Weight/Plane: 7,661g

Legacy rectangular: aluminum
Mated Pair: 192g
Weight/Plane: 22,103g

Legacy rectangular: composite
Mated Pair: 141g
Weight/Plane: 16,123g

Summary:
Using Series 20 composite instead of legacy aluminum connector saves **14,442 grams** (31.8 lbs) per plane.

Using Series 20 composite instead of legacy composite connector saves **8,482 grams** (18.6 lbs) per plane

Series 20 Super-Twin™ Performance

DWV	1500 Vac; 750 VAC (#23 contacts)
Shell-to-Shell	2.5 mΩ
Temp Range	-65°C / +125 °C
Shock*	50 g, half sine, 18x
Vibration*	Random, 8 hrs/axis, Type VI, cond. G (27.8 g)
Altitude Immersion*	12.1 kPa (15000 m / 49000 ft)
Lightning Indirect Effects	3 kA min

*Test by similarity, Series 79 Micro-Crimp



SERIES 28

HiPer-D Connectors

High-performance M24308 intermateable

The HiPer-D connector is a M24308-type D-Subminiature connector with superior design features. Unlike standard M24308 connectors with stamped steel shells, the HiPer-D connector features a one-piece machined shell, and is rated for 200°C continuous operating temperature. Aerospace grade fluorosilicone grommets and face seals provide environmental protection. The HiPer-D is intermateable, intermountable and interchangeable with standard M24308 D-Sub connectors. A ground spring offers enhanced EMI/RFI protection.

- Advanced temperature, vibration and EMC/ electrical performance
- 11 standard and 20 combo insert arrangements
- High temperature epoxy insulators
- Watertight sealing
- Rugged machined one-piece shell

STANDARD AND HIGH DENSITY CONTACT ARRANGEMENTS (face view of pin connector)

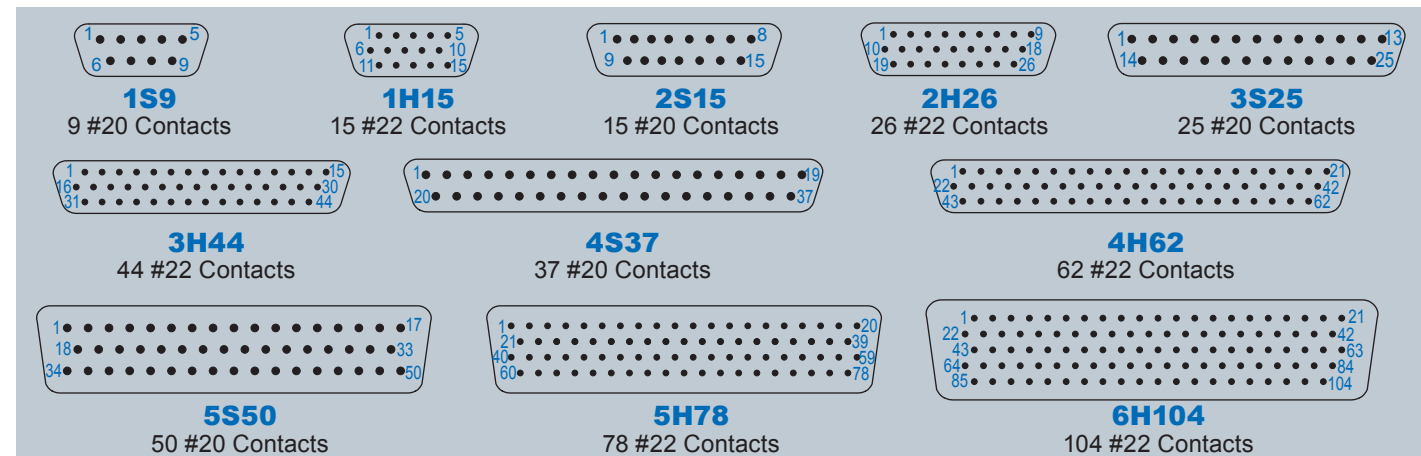

SERIES 28 HiPer-D Connectors

New! Combo-D contact arrangements

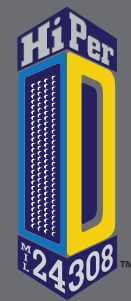

COMBO-D CONTACT ARRANGEMENTS (face view of pin connector)

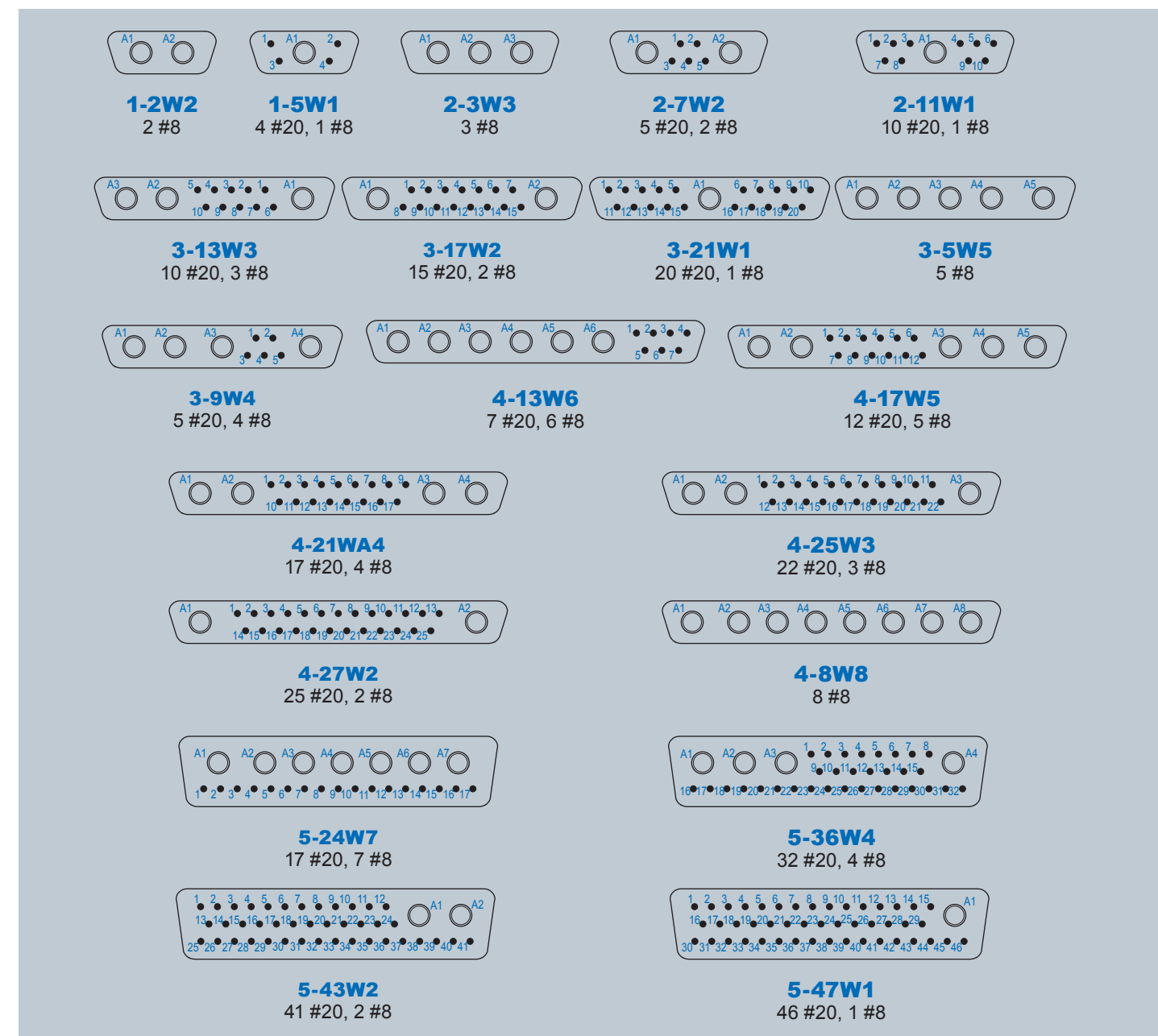



SERIES 240

ARINC 600 Filter Connectors



Glenair manufactures a full range of ARINC 600 filter connectors for use in EMC/EMP management of electronic systems and interconnect cabling. All connectors are designed in accordance with the ARINC 600 specification, and are designed to mate with ARINC 600 plugs with the same insert configuration and opposite contact gender. Planar filter arrays and TVS diodes may be integrated into both standard catalog as well as build-to-order configurations. Glenair's state-of-the-art diode burn-in process tests leaded and surface mount diodes with leakage current monitored throughout the entire test procedure ensuring field reliability.

Table I: Capacitor Array Code / Capacitance Range

Class	Pi - Circuit (pF)	C - Circuit (pF)
X	160,000 - 240,000	80,000 - 120,000
Y	80,000 - 120,000	40,000 - 60,000
Z	60,000 - 90,000	30,000 - 45,000
A	38,000 - 56,000	19,000 - 28,000
B	32,000 - 45,000	16,000 - 22,500
C	18,000 - 33,000	9,000 - 16,500
D	8,000 - 12,000	4,000 - 6,000
E	3,300 - 5,000	1,650 - 2,500
F	800 - 1,300	400 - 650
G	400 - 600	200 - 300
J	70-120	35-60



ARINC 600 size 2 filter connector. Glenair also manufactures narrow-profile size 1 and double-wide size 3. All configurations are environmentally sealed for rugged airframe applications.

- Planar, multilayer ceramic capacitive filters, with and without transient voltage suppression diodes
- C and Pi electrical configurations
- PC tail or solder cup wire termination
- 36 – 240,000 pF capacitance
- Insert arrangements IAW ARINC 600
- Fast and reliable diode burn-in and test services
- Turnkey in-house manufacturing of all filter connector elements and processes

SERIES 240 ARINC 600 Filter connectors Fast, reliable in-house manufacturing

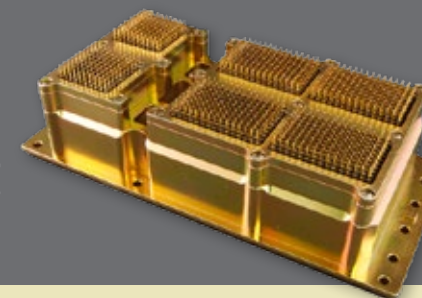

Also available: ARINC 800 and build-to-order ARINC filter solutions. Consult factory for more information

ARINC 600 SIZE 2 AND 3 INSERT ARRANGEMENTS

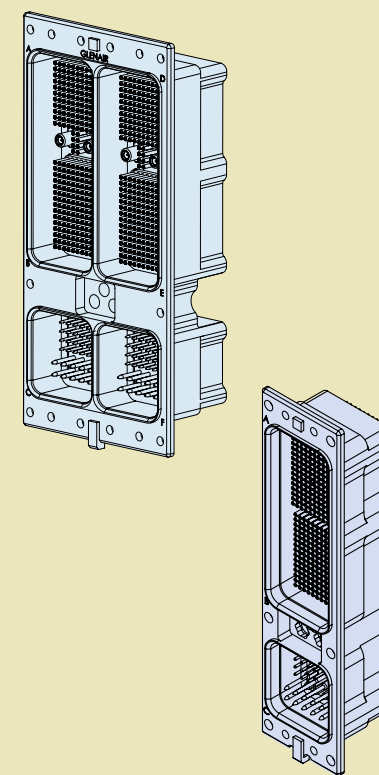

 Insert 07 100 #22	 Insert 24 20 #20 4 #8 Twinax	 Insert 16 24 #20 10 #16	 Insert 13 6 #8 Twinax (Grounded)	 Insert blank (for cavity C)
 Insert 22 50 #16 4 #12	 Insert 04 2 #5 4 #12 3 #16 4 #20	 Insert 02 150 #22	 Insert 15 110 #22 6 #20 5 #12 (Twinax)	 Insert 05 70 #22 1 #5 (Coax)
 Insert 08 70 #22 1 #5 (Coax)	 Insert blank (for cavity A, B)	 Insert 17 60 #20	 Insert 12 10 #8 Twinax (grounded)	 Insert 14 118 #22 2 #8 (Twinax)

ARINC 600 SIZE 1 INSERT ARRANGEMENTS

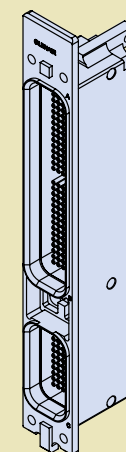

 Insert 01 60 #22	 Insert 20 30 #22 2 #8	 Insert 27 4 #8 insert contains grounded coax, non-filtered
 Insert 03 2 #5 Coax 1 #12 2 #16	 Insert 19 40 #22	 Insert 21 4 #12



METAL AND COMPOSITE Rectangular backshells and accessories

Proven performance backshells and accessories for rectangular connectors

Glenair offers more tested and tooled rectangular interconnect products—including the world's broadest range of rectangular backshells—than any other supplier in the industry. Simply put, from the smallest Micro-D subminiature to the largest ARINC 800, Glenair has an unparalleled range of solutions. Need something light and corrosion free? Glenair is the industry leader in tooled composite thermoplastic connector accessories.



A well designed and fitted backshell can add immeasurably to an interconnect assembly. Designed to accommodate all forms of cable shield termination, mechanical strain-relief and environmental sealing, the backshell is a critical component in every harness application.



- All forms of environmental, mechanical and EMC backshells
- Straight, 45° and 90° cable routing
- High-temp composite thermoplastic and metal shell versions
- To fit all current and legacy rectangular connectors
- Innovative split-shell versions for easy access to wire terminations
- Equally large range of protective covers and caps
- Thousands of part numbers in stock and ready for immediate shipment

METAL AND COMPOSITE
Rectangular backshells and accessories
The world's largest *tooled* selection



MICRO-D AND NANOMINIATURE BACKSHELLS AND CONNECTOR ACCESSORIES



M24308 D-SUB SOLUTIONS: HIGH PERFORMANCE, RUGGEDIZED D-SUBMINIATURE PRODUCTS



LARGER FORM FACTOR RECTANGULAR BACKSHELLS



Fruit or Vegetable?

Many of you will remember that Marv Borden, one of Glenair's original founders, was also an avocado grower. Our regular group lunches with Marv would often turn to talk of his ranch, and stories from his many years in the produce industry. I'd like to share one of those stories with everyone because of the valuable lesson I think it holds.

In the 1960s, California avocado farmers were looking for new export markets for their product, and countries in the Pacific Rim were natural targets—particularly Japan where the population's taste for unusual and prestigious foods looked like fertile ground.

And so, with the help of a big-bucks marketing firm, California avocados were introduced in Japan. A marketing campaign, *Avocados: The Healthy Fruit from California* was launched with special public events and tastings. The results were disastrous. Picture gagging Japanese spitting samples into hastily retrieved napkins.

So what was the problem? Why did the Japanese find the avocado so distasteful? Well it turns out that, to a large degree, the use of the term "fruit" in signs and advertising was the problem. Japanese "naturally" expected anything called fruit to be sweet and juicy, and were shocked at the avocado's savory flavor. Japanese advisors to the campaign explained the problem and recommended simply re-branding the fruit as a vegetable. But the California growers were adamant, "Avocados grow on trees and have pits, so they must be classified and described as fruit."

Happily, sounder minds (on the sales sides of the enterprise) prevailed and the Japanese promotional campaign was subsequently re-launched—with a little poetic license—as *Avocados: The Healthy Vegetable from California*. No longer confused by the "fruit" moniker, the Japanese embraced avocados as a unique and versatile vegetable.

You can probably guess the rest of the story. This year it's projected Japan will import over 60,000 tons of avocados—all due to a salesman's decision to willingly view the opportunity through his customer's eyes instead of his own.

And this is the point I want to make for everyone in the Glenair family: There is no upside in viewing any aspect of a business deal solely from one perspective. We should endeavor as well to see the world through the eyes of the other guy; to resist the temptation to believe we alone have the correct view of any problem (or opportunity!). To do otherwise is a kind of arrogance that has no place in our ongoing commitment to fostering win-win relationships with our customers, colleagues, suppliers and partners.

Thanks for reading this fun bit of history. I'm sure Marv would love it that his many stories are still being told around Glenair.

Chris Toomey

Publisher

Christopher J. Toomey

Executive Editor

Marcus Kaufman

Managing Editor

Carl Foote

Editor/Art Director

Mike Borgsdorf

Graphic Designer

George Ramirez

Technical Consultant

Jim Donaldson

Issue Contributors

Becki Archuleta
Deniz Armani
Mark Bushell
Stewart Clark
Brian Clausen
Brendan Dempsey
Tony Han
Joseph Hsuing
Dylan Milo
Jim Plessas
Fred VanWyk

Distribution

Terry White

QwikConnect is published quarterly by Glenair, Inc. and printed in the U.S.A. All rights reserved. © Copyright 2013 Glenair, Inc. A complete archive of past issues of QwikConnect is available on the Internet at www.glenair.com/qwikconnect

GLENAIR, INC.

1211 AIR WAY
GLENDALE, CA 91201-2497
TEL: 818-247-6000
FAX: 818-500-9912
E-MAIL: sales@glenair.com
www.glenair.com

