

660-108

Protective Cover for TNC Receptacle

TNC Receptacle Cover



660-106 protective cover fits type N plug connectors. Aluminum or stainless steel, with stainless steel fittings. Silicone gasket.

TABLE 1 MATERIAL / FINISH

Aluminum		Stainless Steel	
M	Electroless Nickel	Z1	Passivate
NF	Olive Drab Cadmium	ZM	Nickel-plated
MT	Nickel-PTFE		
ZR	Black Zinc-Nickel		

PART NUMBER

660-108	ZR	U	04	-3
Base P/N	660-108			
Material/Finish	See Table 1			
Attachment Type	N No Attachment See Table 2 for Attachment Types			
Attachment Ring	Omit for Attachment Type N 00 No Ring See Table 3 for Attachment Ring Codes			
Attachment Length	Omit for Attachment Type N Length in One Inch Increments			

TABLE 2 ATTACHMENT TYPE







D	 SST Bead Chain .125 (3.2) diameter, size 6, -65 to +200 °C
F	 Wire Rope, Blue Nylon Jacket 6/6 nylon over stainless steel rope, fair flexibility, good abrasion resistance, -55 to +100 °C
G	 Black Nylon Rope Very flexible, good abrasion and fuel resistance, .094 (2.4) diameter, -55 to +100 °C
H	 Wire Rope, Clear FEP Jacket Clear FEP jacket over SST rope, fair flexibility, good abrasion resistance, .100" diameter, -65 to +200 °C
S	 Sash Chain #8 sash chain, stainless steel. Length tolerance is ± one link .280 (Z1)
T	 SST Wire Rope, No Jacket Good flexibility, good abrasion resistance, .047 (1.2) diameter, passivated, -65 to +200 °C
U	 SST Wire Rope, Black Polyurethane Black polyurethane coating, very flexible, excellent abrasion resistance, .080" (2mm) diameter, -55 to +125 °C

TABLE 3 ATTACHMENT RING

EYELET		
	Code	Eyelet I.D.
	06	.125 (3.2)
	01	.140 (3.6)
	02	.182 (4.6)
	04	.197 (5.0)
SOLID RING		
	Code	Ring I.D.
	095	.312 (7.9)
	100	.391 (9.9)
	101	.516 (13.1)
	102	.583 (14.8)
	103	.641 (16.3)
	104	.708 (18.0)
	105	.766 (19.5)
	106	.896 (22.2)
	107	1.016 (25.8)
SPLIT RING		
	Code	Ring I.D.
	52	.485 (12.3)
	54	.640 (16.3)
	56	.750 (19.1)
	58	.890 (22.6)
	60	1.015 (25.8)

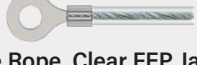

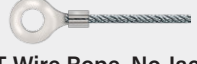
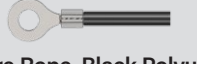
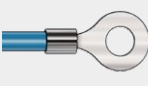
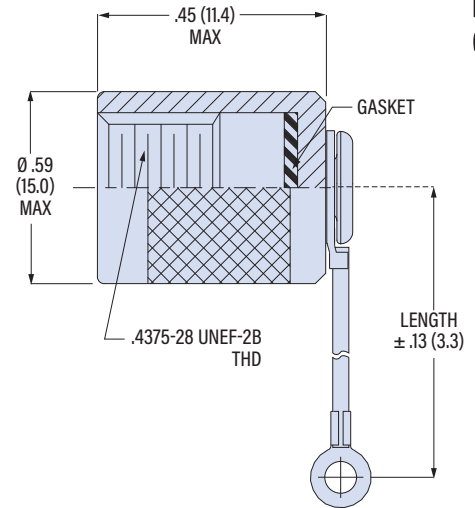
RF CONNECTOR ACCESSORIES