

MISSION-CRITICAL
INTERCONNECT
SOLUTIONS

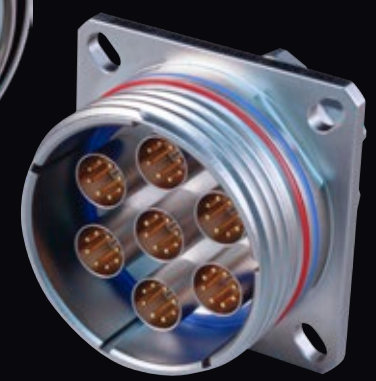

Glennair
SIGNATURE SERIES

High-Speed Interconnect Solutions

Rugged Electrical, Optical, and Hybrid Solutions for
Mission-Critical Aerospace and Defense Applications

Rugged High-Speed Interconnect Solutions

Electrical, Optical, and Hybrid Solutions for Mission-Critical Aerospace and Defense Applications



EL OCHITO® HIGH-SPEED OCTAXIAL CONTACTS AND CONNECTOR PACKAGING



El Ochito® high-speed octaxial contacts

SuperFly nano miniature with El Ochito®

Series 792 micro miniature with El Ochito®

Series 806 Mil-Aero micro miniature with El Ochito®

EL OCHITO® PACKAGING (continued)



Series 23 SuperNine® with El Ochito®

SIGNATURE HIGH-SPEED CONNECTOR SOLUTIONS



Series 23 SuperNine® with SpeedMaster™ 10G high-speed contacts

Octobyte™ industrial-strength Ethernet connectors

SIGNATURE HIGH-SPEED CONNECTOR SOLUTIONS (continued)



SuperSeal™ RJ45 Ethernet and USB ruggedized field connectors

Micro-D form-factor connector with VersaLink™ differential Twinax plus VersaLink™ Bridge

High-Speed Micro-D high-density SWaP solution

GLENAIR SIGNATURE BUTT-JOINT FIBER OPTIC INTERCONNECT SOLUTIONS



Rugged MIL-DTL-38999 type fiber optic

Glenair High Density (GHD) rugged fiber optic

Glenair Front Release (GFR) rugged fiber optic

SIGNATURE FIBER OPTIC SOLUTIONS (continued)



Rugged MT Ferrule solutions for 38999 and Series 791

RUGGED HIGH-SPEED ELECTRICAL-OPTICAL MEDIA CONVERTERS

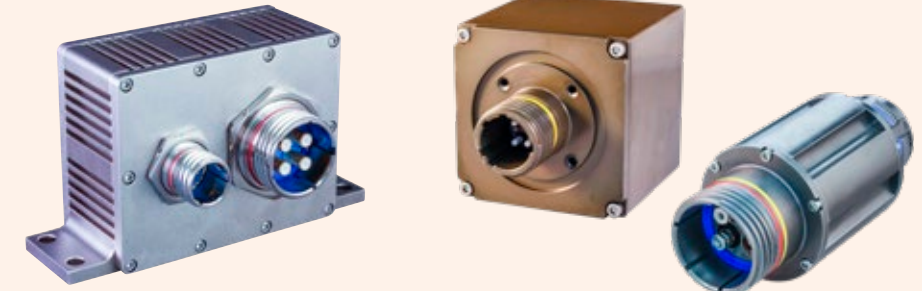

Copper-to-fiber media converters for video applications

Copper-to-fiber media converters for Ethernet applications

RUGGED PCB-MOUNT TRANSCEIVERS FOR ETHERNET, HIGH-SPEED VIDEO, AND STORAGE



EMI shielded and radiation-tolerant transceivers

Dual transmitters, quad receivers

Bi-directional transceivers

Small form-factor, high-vibration, high-temperature tolerant

RF-OVER FIBER AND HIGH-DATARATE PARALLEL OPTICAL TRANSCEIVERS

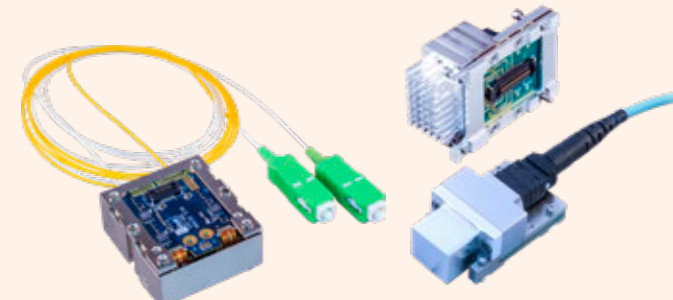

RF-over-fiber low-noise PCB-mount transceiver

Parallel optical 40 Gb/s PCB-mount transceivers

SIZE #8 PHOTONIC TRANSMITTER AND RECEIVER CONTACTS FOR HIGH-SPEED DATA



Opto-electronic receptacle connectors populated with Size #8 Photonic transmitter and receiver contacts

El Ochito®

High-speed octaxial contacts for Ethernet, SuperSpeed USB and multi-gigabit datalinks

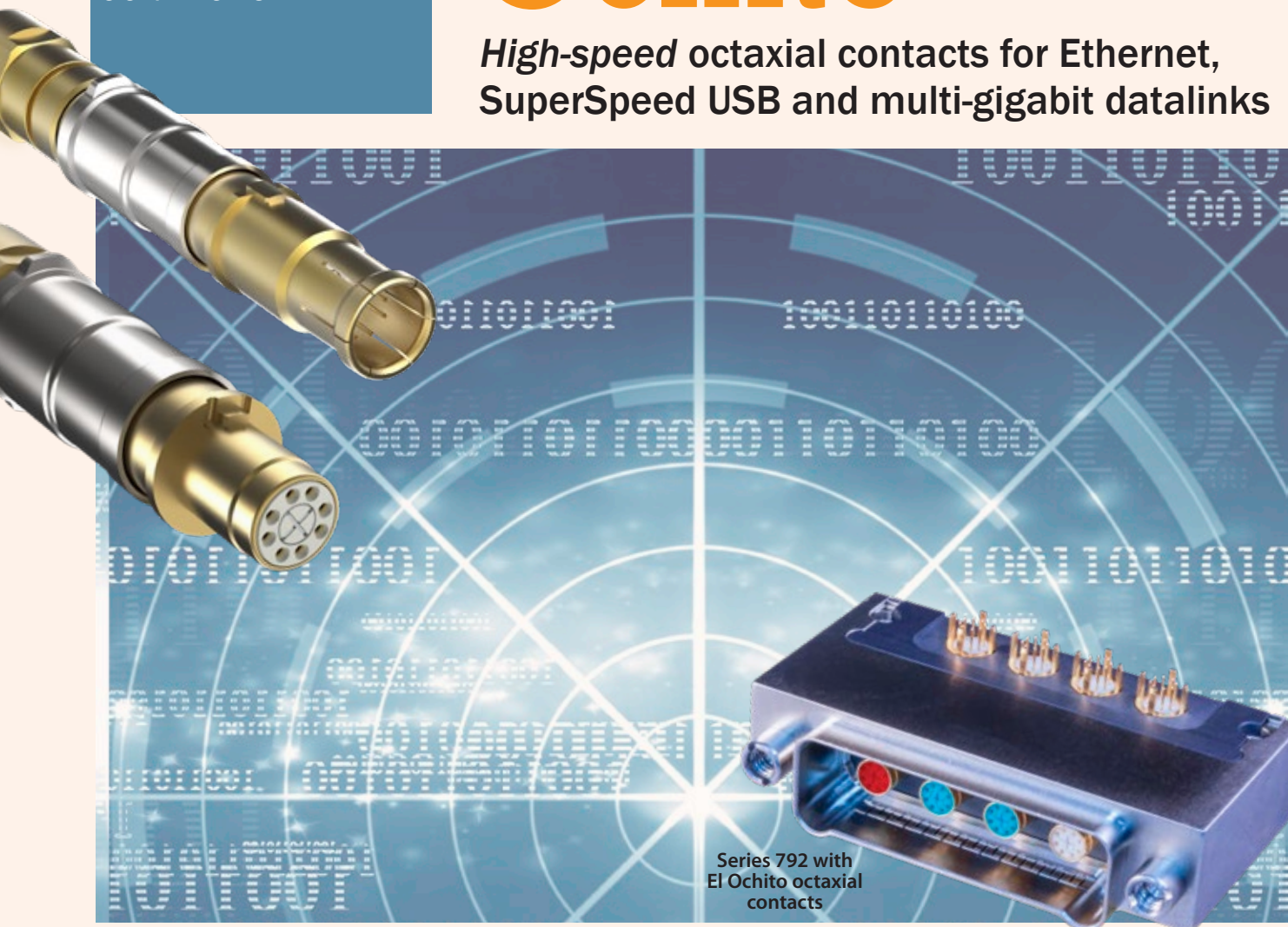

Series 792 with El Ochito octaxial contacts

High speed, harsh environment El Ochito® octaxial contacts save size and weight in aircraft avionics, weapons systems, satellites, radars, and communications equipment.

AVAILABLE SIGNATURE CONNECTOR PACKAGING INCLUDES



SuperFly
Nanominiature

806 Mil-Aero
Micro miniature

SuperNine
"Better than QPL" 38999

- 10GbE, SuperSpeed USB, and multi-gigabit shielded pairs
- Universal drop-in for keyed size #8 connector cavities
- Data-pair isolation for optimal signal integrity
- Crimp or threaded shield termination contact types
- Snap-in, rear release
- Environmentally sealed
- Aerospace-grade cable assemblies
- 50% cable / contact reduction compared to Quadrax

HIGH-SPEED OCTAXIAL El Ochito® Contacts



Protocols, exploded views of Type I and Type II contacts

El Ochito® White	El Ochito® Blue	El Ochito® Red
1000BASE-T, 10GBASE-T	SuperSpeed USB	HDMI, DisplayPort, SATA
El Ochito® White octaxial contacts provide 10GbE in a single size #8 contact cavity (compared to two Quadrax) for 100BASE-T solutions.	<i>Low-dielectric material. 90 ohms.</i> El Ochito® Blue octaxial contacts provide an aerospace-grade solution for SuperSpeed USB 3.0	<i>Low-dielectric material. Up to 5 Gbps. 100 ohms.</i> El Ochito® Red octaxial contacts provide an aerospace-grade solution for multi-gigabit data rates.

El Ochito® Type I Contacts, Non-Serviceable

26 AWG, Crimp Wire Shield Termination

Type I Pin Contact

Type I Socket Contact

El Ochito® Type II Contacts, Serviceable

24-26 AWG, Threaded Wire Shield Termination, Integral Contact Release Sleeve

Type II Pin Contact

Type II Socket Contact

El Ochito® Contacts: How To Order								
Connector Type	Wire Size	Cable Type	Cable		El Ochito® Type I		El Ochito® Type II	
			Glenair Part No. <i>(Mfg. P/N)</i>	Cable Dia.	Pin Contact <i>Assembly Instr.</i>	Skt Contact <i>Assembly Instr.</i>	Pin Contact <i>Assembly Instr.</i>	Skt Contact <i>Assembly Instr.</i>
ARINC 600	26	S/UTP	963-003-26 (PIC E6A3826)	.220 (5.56)	858-009-01 AI85074-01	858-010-01 AI85074-01		
		S/FTP	963-033-26 (Gore RCN9047-26)	.220 (5.56)	858-009-02 AI85084-01	858-010-02 AI85084-01		
Series 23 SuperNine® Series 801 and 805 Mighty Mouse	24	S/UTP	963-037-24	.260 (6.60)			858-005-03 AI85097-03	858-006-03 AI85097-03
		S/FTP	963-033-24	.260 (6.60)			858-005-04 AI85097-04	858-006-04 AI85097-04
Series 28 HiPer-D®	26	S/UTP	963-003-26 (PIC E6A3826)	.220 (5.56)	858-003-01F AI85048-01	858-004-01F AI85048-01	858-005-01 AI85097-01	858-006-01 AI85097-01
		S/FTP	963-033-26 (Gore RCN9047-26)	.220 (5.56)	858-003-02F AI85048-02	858-004-02F AI85048-02	858-005-02 AI85097-01	858-006-02 AI85097-01
Series 792	24		963-037-24 (PIC E6A3824)	.260 (6.60)			858-043-03 AI85134-03	858-042-03 AI85134-03
			963-033-24 (Gore RCN9047-24)	.260 (6.60)			858-043-04 AI85134-04	858-042-04 AI85134-04
	26	S/UTP	963-003-26 (PIC E6A3826)	.220 (5.56)	858-045-01F AI85048-01	858-046-01F AI85048-01	858-043-01 AI85134-01	858-042-01 AI85134-01
		S/FTP	963-033-26 (Gore RCN9047-26)	.220 (5.56)	858-045-02F AI85048-02	858-046-02F AI85048-02	858-043-02 AI85134-02	858-042-02 AI85134-02
Series 806	24	S/UTP	963-037-24 (PIC E6A3824)	.260 (6.60)			858-051-03 AI85149-03	858-052-03 AI85149-03
		S/FTP	963-033-24 (Gore RCN9047-24)	.260 (6.60)			858-051-04 AI85149-04	858-052-04 AI85149-04
	26	S/UTP	963-003-26 (PIC E6A3826)	.220 (5.56)	858-045-01F AI85048-01	858-046-01F AI85048-01	858-051-01 AI85149-01	858-052-01 AI85149-01
		S/FTP	963-033-26 (Gore RCN9047-26)	.220 (5.56)	858-045-02F AI85048-02	858-046-02F AI85048-02	858-051-02 AI85149-02	858-052-02 AI85149-02
EPXB	26	S/UTP	963-003-26 (PIC E6A3826)	.220 (5.56)	858-014-02F AI85099-01	858-015-02F AI85099-01		
		S/FTP	963-033-26 (Gore RCN9047-26)	.220 (5.56)	858-014-01F AI85105-01	858-015-01F AI85105-01		

El Ochito® Contacts: How To Order						
Connector Type	Wire Size	Cable Type	Cable		El Ochito® Type I	
			Glenair Part No.	Cable Dia.	Pin Contact <i>Assembly Instr.</i>	Socket Contact <i>Assembly Instr.</i>
Series 792 and 806	26	Commercial Grade (PVC Jacket)	963-118	.217 (5.51)	858-047-01F AI85114-02	858-048-01F AI85114-02
		Aerospace Grade (Fluoropolymer Jacket)	963-110	.236 (5.99)	858-047-02F AI85090-01	858-048-02F AI85090-01
Series 23 SuperNine® Series 801 and 805 Mighty Mouse Series 28 HiPer-D®	26	Commercial Grade (PVC Jacket)	963-118	.217 (5.51)	858-028-01F AI85114-02	858-029-01F AI85114-02
		Aerospace Grade (Fluoropolymer Jacket)	963-110	.236 (5.99)	858-028-02F AI85090-01	858-029-02F AI85090-01
ARINC 600	26	Commercial Grade (PVC Jacket)	963-118	.217 (5.51)	858-038-01 AI85124-01	858-035-01 AI85124-01
		Aerospace Grade (Fluoropolymer Jacket)	963-110	.236 (5.99)	858-038-02 AI85124-02	858-035-02 AI85124-02
Connector Type	Wire Size	Cable Type	Cable		El Ochito® Type I	
			Glenair Part No.	Cable Dia.	Pin Contact <i>Assembly Instr.</i>	Socket Contact <i>Assembly Instr.</i>
Series 792 and 806	26	4 Pair S/FTP	1Gb/s and above 963-122-X*	.299 (7.59)	858-049-01F* AI85048-02	858-050-01F* AI85048-02
			Up to 1Gb/s 963-033-26	.220 (5.56)	858-030-02F* AI85048-02	858-031-02F* AI85048-02
ARINC 600			HDMI/Display Port 963-120-X* 963-127-X*	.429 (10.9) .330 (8.38)	858-039-01 AI85084-01	858-037-01 AI85084-01
Series 792 and 806	26	Parallel Pair Twinax	SATA 963-043-26 [2 pcs.]	.116 x .071 (2.95 x 1.80)	858-049-02 AI85084-02	858-050-02 AI85084-02
Series 23 SuperNine® Series 801 and 805 Mighty Mouse Series 28 HiPer-D®					858-030-03 AI85084-03	858-031-03 AI85084-03
ARINC 600					858-039-02 AI85084-02	858-037-02 AI85084-02

* Omit F when using this cable

HIGH-SPEED
ULTRA
MINIATURE
I/O DATALINKS

SUPERFLY[®] DATALINK

The Nano Miniature 10G Ethernet, USB 3.0,
and DisplayPort Connector with El Ochito[®]
Octaxial Contact Technology



High speed, harsh environment SuperFly[®] Datalink connectors—
with shielded El Ochito[®] octaxial contacts for 10Gb Ethernet,
SuperSpeed USB, and high datarate video display protocols—
deliver outstanding signal integrity and save significant size and
weight compared to Quadrax.



**SuperFly Datalink
White**

1000BASE-T Ethernet
10G Ethernet



**SuperFly Datalink
Blue**

USB 2.0
SuperSpeed USB 3.0



**SuperFly Datalink
Red**

eSATA / SATA
DVI-D (single)
HDMI • DisplayPort

- Ultra-small size
- Shielded Octaxial contacts
- Up to 5 Gbps
- 10Gb Ethernet and SuperSpeed USB
- New Red insert for high-speed video, consult factory for layouts
- Environmentally protected
- Factory-terminated cables or discrete contacts and cables for customer assembly

SERIES 882 SuperFly[®] Datalink



The high-speed nano miniature connector
for harsh environments

CONNECTOR CONFIGURATIONS

Quick -disconnect “push-pull” versions are ideal for tactical gear. Threaded-coupling versions are intended for aircraft and space-grade applications where secure mating is a requirement.



Quick Disconnect



Threaded Coupling



Straight PC Tails



Right Angle PC Tails



Conformal-coating-compliant panel mount connectors

Push-Pull Quick-Disconnect

Latching EMI Springs

O-ring Interface Seal

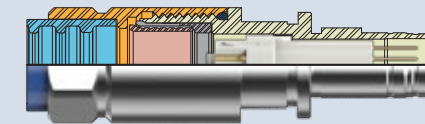

882-001
Plug Connector

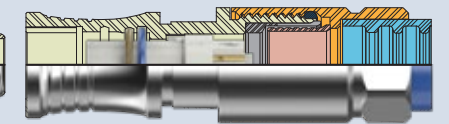

882-002
Receptacle Connector

Push-pull SuperFly Datalink receptacle connectors feature two canted coil springs for secure mating and excellent EMI protection. A fluorosilicone O-ring provides watertight sealing when mated.

Cable Connector

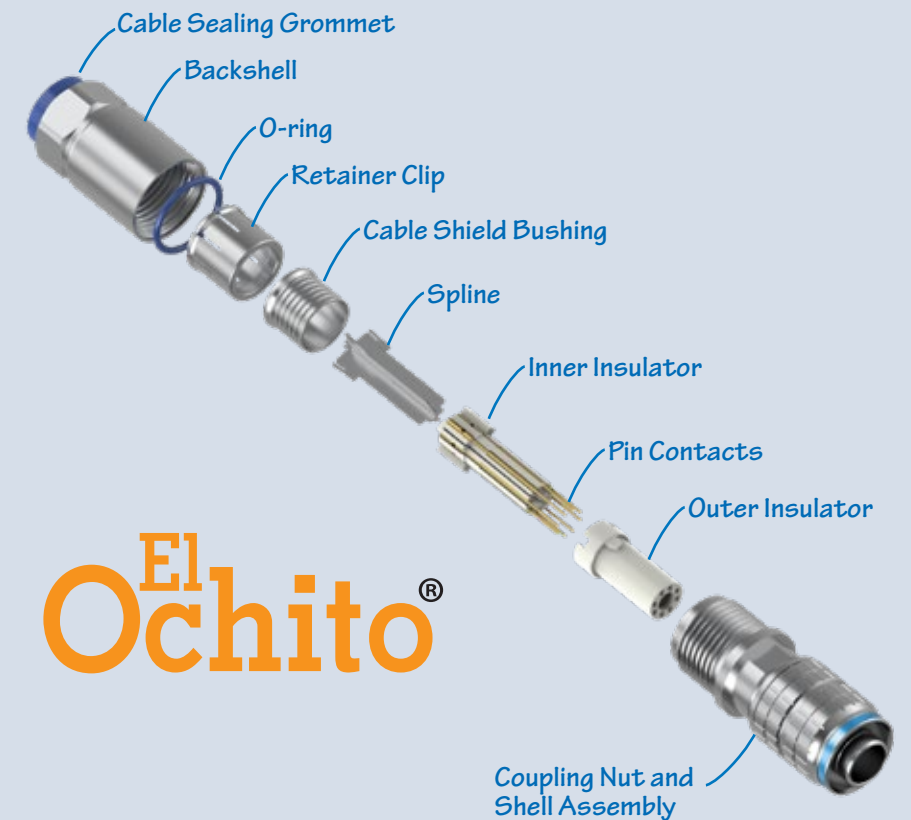

Cable connectors feature gold-plated crimp contacts, precision insulators, integral backshell, sealing grommet and machined shells.



SuperFly Datalink Connectors, Octaxial, White

White dielectric indicates 100 ohm differential impedance for Ethernet protocols. Ideal for 1000BASE-T and 10GBASE-T applications in hostile environments with temperature extremes, high vibration, electromagnetic interference, as well as moisture exposure. Compatible with SAE AS6070 200°C flight-grade cable. Accepts 24 AWG or 26 AWG wire sizes. Available with secure threaded coupling or push-pull mating.

Quick Disconnect for 10Gb Ethernet



882-001 Cable Plug

Integral backshell and cable grommet. Supplied as unassembled kit for termination to Cat 6A Ethernet cable.



882-002 Cable Receptacle

Integral backshell and cable grommet. Supplied as unassembled kit for termination to Cat 6A Ethernet cable. Mates to 881-001.



882-005 Panel Receptacle, PCB

Rear panel jam nut mount receptacle has O-ring seals and epoxy potting for watertight sealing. Mates with 882-001.



882-008 Panel Receptacle, 90° PCB

Rear panel jam nut mount receptacle has O-ring seals and epoxy potting for watertight sealing. Mates with 882-001.



8571-0007 Cordset, Single-Ended

Pre-wired with aerospace-grade CAT 6A Ethernet cable. Cable has plug or receptacle on one end, other end is unterminated.



8571-0008 Cordset, Double-Ended

Pre-wired with aerospace-grade CAT 6A Ethernet cable. Cable has plug on one end and receptacle on the other end.



8571-0009 RJ45 Patchcord, Ground

Pre-wired with commercial-grade CAT 6A Ethernet cable. Cable has RJ45 plug on one end and plug or receptacle on the other end.



8571-0010 RJ45 Patchcord, Flight

Pre-wired with flight-grade CAT 6A Ethernet cable. Cable has RJ45 plug on one end and plug or receptacle on the other end.

Threaded Coupling for 10Gb Ethernet



882-003 Cable Plug

Integral backshell and cable grommet. Supplied as unassembled kit for termination to Cat 6A Ethernet cable.



882-006 Cable Receptacle

Integral backshell and cable grommet. Supplied as unassembled kit for termination to Cat 6A Ethernet cable. Mates with 882-003.



882-004 Panel Receptacle, PCB

Rear panel jam nut mount receptacle has O-ring seals and epoxy potting for watertight sealing. Mates with 882-003.



882-007 Panel Receptacle, 90° PCB

Rear panel jam nut mount receptacle has O-ring seals and epoxy potting for watertight sealing. Mates with 882-003.



8571-0012 Cordset, Single-Ended

Pre-wired with aerospace-grade CAT 6A Ethernet cable. Cable has plug or receptacle on one end, other end is unterminated.



8571-0013 Cordset, Double-Ended

Pre-wired with aerospace-grade CAT 6A Ethernet cable. Cable has plug on one end and receptacle on the other end.



8571-0015 RJ45 Patchcord, Ground

Pre-wired with commercial-grade CAT 6A Ethernet cable. Cable has RJ45 plug on one end and plug or receptacle on the other end.



8571-0016 RJ45 Patchcord, Flight

Pre-wired with flight-grade CAT 6A Ethernet cable. Cable has RJ45 plug on one end and plug or receptacle on the other end.

Flight-Grade 100 Ohm Ethernet Cable



963-033 S/FTP Cable

24 and 26 AWG. S/FTP construction, foil shielded data pairs. High performance shielded cable is AS6070/5 and /6 approved.



963-003 and 963-037 S/UTP Cable

24 and 26 AWG. S/UTP construction with fluoropolymer spline. Meets FAA flammability requirements.



SuperFly Datalink Connectors, Octaxial, Blue

Blue dielectric indicates 90 ohm differential impedance for SuperSpeed USB. Ideal for USB 3.0 applications in hostile environments with temperature extremes, vibration, electromagnetic interference and moisture exposure. Designed for use with high performance aerospace grade USB 3.0 cable. Available with threaded coupling or push-pull mating.

Quick Disconnect for USB 3.0



882-009 Cable Plug

Integral backshell and cable grommet. Supplied as unassembled kit for termination to USB 3.0 cable.



882-010 Cable Receptacle

Integral backshell and cable grommet. Supplied as unassembled kit for termination to USB 3.0 cable. Mates to 881-009.



882-013 Panel Receptacle, PCB

Rear panel jam nut mount receptacle has O-ring seals and epoxy potting for watertight sealing. Mates with 882-009.



882-016 Panel Receptacle, 90° PCB

Rear panel jam nut mount receptacle has O-ring seals and epoxy potting for watertight sealing. Mates with 882-009.



8572-0006 Cordset, Single-Ended

Pre-wired with aerospace-grade or commercial-grade USB 3.0 cable. Cable has plug or receptacle on one end, other end is unterminated.



8572-0007 Cordset, Double-Ended

Pre-wired with aerospace-grade or commercial-grade USB 3.0 cable. Cable has plug on one end and receptacle on the other end.



8572-0008 Patchcord, USB

Pre-wired with commercial-grade USB 3.0 cable. Cable has standard USB connector on one end, other end is SuperFly Datalink.

Threaded Coupling for USB 3.0



882-011 Cable Plug

Integral backshell and cable grommet. Supplied as unassembled kit for termination to USB 3.0 cable.



882-014 Cable Receptacle

Integral backshell and cable grommet. Supplied as unassembled kit for termination to USB 3.0 cable. Mates with 882-011.



882-012 Panel Receptacle, PCB

Rear panel jam nut mount receptacle has O-ring seals and epoxy potting for watertight sealing. Mates with 882-011.



882-015 Panel Receptacle, 90° PCB

Rear panel jam nut mount receptacle has O-ring seals and epoxy potting for watertight sealing. Mates with 882-011.



8572-0010 Cordset, Single-Ended

Pre-wired with aerospace-grade or commercial-grade USB 3.0 cable. Cable has plug or receptacle on one end, other end is unterminated.



8572-0011 Cordset, Double-Ended

Pre-wired with aerospace-grade or commercial-grade USB 3.0 cable. Cable has plug on one end and receptacle on the other end.



8572-0013 Patchcord, USB

Pre-wired with commercial-grade USB 3.0 cable. Cable has standard USB connector on one end, other end is SuperFly Datalink.

90 Ohm USB 3.0 Cable



963-110 Flight-Grade Cable

High temperature, high performance, fluoropolymer aterials, shielded. High speed pairs have braid shields. -65° to +200°C.



963-118 Commercial-Grade Cable

Black PVC jacket, foamed PE wire insulation. High speed pairs have foil shields. 0 to +80°C.

HIGH-SPEED
RACK-AND-PANEL
CONNECTOR
WITH EL OCHITO®
OCTAXIAL CONTACTS



The next-generation micro miniature rectangular connector with El Ochito contacts for high-speed aerospace applications



The Series 792 connector brings high-speed data-rate performance to the Glenair Series 79 rectangular family. Size 8 cavities accept standard Quadrax or El Ochito® shielded octaxial contacts making it a perfect choice for radars, weapons systems, mission computers and displays, communications gear, and more.

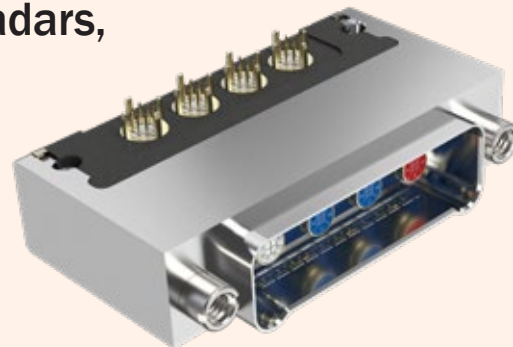

- High-speed Ethernet, USB 3.0, HDMI, and DisplayPort
- PCB-mount and cable connectors
- Scoop-proof interface
- 12 arrangements and 6 shell sizes
- Precision-machined dual-lobe polarized shells
- Environmentally sealed
- Integrated EMI shielding and grounding
- Blind mating

HIGH-SPEED Series 792



The next-generation micro miniature rectangular for high-speed aerospace applications

DESCRIPTION	REQUIREMENT	PROCEDURE / NOTES	DESCRIPTION	REQUIREMENT	PROCEDURE / NOTES
Operating temperature	-65° to +175°C	EIA-364-32 Test Condition IV	Shell-to-shell resistance	2.5 millivolt maximum	EIA-364-83
Current rating	1.5 Amps (datalink contacts) 5 Amps (Size #23 contacts)	Datalink contacts tested: El Ochito® White	Shielding effectiveness	Frequency	Attenuation dB
DWV (sea level)	750 VAC (Size #23 contacts) 1000 VAC (datalink contacts)	EIA-364-20		100	75
Insulation resistance	5000 MΩ minimum	EIA-364-21		1000	50
				3000	44
6000	38				
10000	35				
Contact resistance, 25°C	55 millivolt maximum	EIA-364-06, 1.0 A test current, #24 AWG wire	Ingress protection	IP67 rating	IEC-60529

Insert Arrangements

Contact Key
 Size #8
 Size #23

* Grounded aluminum insert

The next-generation micro miniature rectangular for high-speed / high-data rate aerospace applications



The next-generation micro miniature rectangular for high-speed / high-data rate aerospace applications



Save Size and Weight with Series 792 Connectors
The Multi-Port Multi-Protocol Connector with El Ochito® Contacts

About The Series 792

The Series 792 brings high-speed board-to-wire capability to the Glenair Series 79 family of ultraminiature rectangular connectors. The Series 792 is intended for avionics and aerospace equipment exposed to high-vibration and hostile environments.

The 792 supports quadrax contacts for ARINC 664 and El Ochito® octaxial contacts for 10Gb Ethernet, USB 3.0, HDMI and other protocols.

Machined aluminum alloy shells feature dual lobes for polarization. Pin contacts are recessed to prevent scooping damage. Crimp contacts conform to M39029 requirements and are rear release.

An optional ground spring in the receptacle minimizes EMI. Fluorosilicone face seals and wire grommets protect from moisture and contamination. Panel mount versions are available with an O-ring—or for improved panel bonding—a metal spring.

Board mount versions include straight or right angle terminals. Right angle PCB connectors feature an aluminum cover for added EMI protection.



Twinax, Quadrax and El Ochito®
Connectors are available in three configurations: twinax for a single high-speed wire pair, quadrax for two data pairs, and El Ochito® for four data pairs.



PCB Connectors

Series 792 PCB connectors have straight or right angle PC tails. Contacts are non-removable and are epoxy sealed. Right-angle connectors eliminate the need for board-to-panel I/O jumpers.



El Ochito® White: GbE, 10GbE
El Ochito® Blue: USB 3.0
El Ochito® Red: HDMI, SATA, DisplayPort

El Ochito® Contacts

Series 792 connectors feature El Ochito® octaxial contacts for Ethernet, SuperSpeed USB, HDMI, DisplayPort, SATA and other multi-gigabit protocols. Multiple protocols can be supported in a single multi-port connector.

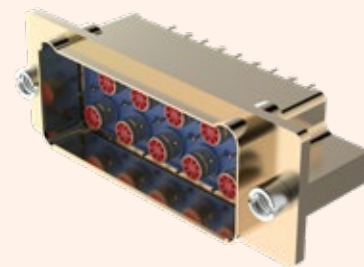

Up to 9 data ports

The Series 792 Size F with nine ports is the largest connector in the series and is the only two row version. Sizes A – E, with one to five ports, are single row.



Panel Mount

Panel mount connectors have an O-ring and threaded mounting holes for easy installation. Suitable for blind mate modules, the Series 792 is available with guide pins and float mounts.



Cable Connectors

Quadrax and El Ochito® contacts snap into Series 792 cable connectors and are easily removed with a standard plastic tool. Alignment keys provide correct orientation.

Cable Connectors Snap-in crimp contacts		Panel Mount Connectors Snap-in crimp contacts		Float Mount Connectors Snap-in crimp contacts	
Plug	Receptacle	Plug	Receptacle	Plug	Receptacle
792-001	792-002	792-003	792-004	792-013	792-014

El Ochito® Printed Circuit Board Connectors with Octaxial Contacts Epoxy-sealed non-removable PCB terminals							
Straight PCB		Panel Mt Straight PCB		90° PCB		Panel Mount 90° PCB	
Plug	Receptacle	Plug	Receptacle	Plug	Receptacle	Plug	Receptacle
792-005	792-006	792-007	792-008	792-009	792-010	792-011	792-012

Quadrax Printed Circuit Board Connectors Epoxy-sealed non-removable PCB terminals							
Straight PCB		Panel Mt Straight PCB		90° PCB		Panel Mount 90° PCB	
Plug	Receptacle	Plug	Receptacle	Plug	Receptacle	Plug	Receptacle
792-018	792-019	792-020	792-021	792-022	792-023	792-024	792-025

Series 792 High-speed Ultraminiature Rectangular Connectors with El Ochito® Octaxial Contacts

El Ochito® White GbE 10GbE	El Ochito® Blue USB 3.0	El Ochito® Red HDMI, SATA, DisplayPort

- 10GbE, SuperSpeed USB, and multi-gigabit shielded pairs
- Crimp shield termination and threaded contact types
- Snap-in, rear release
- Environmentally protected
- Aerospace-grade performance

RECOMMENDED BACKSHELL

799-164
Split EMI Banding Backshell

Metal EMI Panel Spring

A gold-plated panel spring option is available for Series 792 connectors with panel mount flanges. This spring provides improved electrical bonding.

NEXT-GENERATION
HIGH-SPEED
MICRO
MINIATURE
CONNECTORS



Advanced performance,
reduced size and weight
connector series IAW
MIL-DTL-38999



Innovative design meets key performance benchmarks for harsh vibration, shock, and environmental settings—as well as high-altitude, unpressurized aircraft zones with aggressive voltage ratings and altitude immersion standards.

SAVE SIZE AND WEIGHT WITH SERIES 806 CONNECTORS

Series 806 Mil-Aero
Smallest Size
.500 In. Mating Threads
3 #20 Contacts or 7 #22
contacts



MIL-DTL-38999
Smallest Size
.625 In. Mating Threads
3 #20 Contacts or 6 #22
contacts



- High-speed Ethernet, USB 3.0, HDMI, and DisplayPort
- Next-generation small form factor aerospace-grade circular connector
- Upgraded environmental, electrical and mechanical performance
- Integrated anti-decoupling technology
- High-Speed El Ochito® and hybrid #22HD contact arrangements

HIGH-SPEED
Series 806 Mil-Aero
Micro Miniature Circular Connectors
with El Ochito® octaxial contacts



Series 806 with El Ochito® contact arrangements

Insert Arrangement	10-1	14-20A	16-2	16-22
No. of Contacts	1x #8	1x #8 19x #22HD	2x #8	2x #8 20x #22HD

Insert Arrangement	18-3	18-21	20-4	20-28
No. of Contacts	3x #8	3x #8 18x #22HD	4x #8	4x #8 24x #22HD

Insert Arrangement	22-5	22-44	24-8	24-97
No. of Contacts	5x #8	4x #8 40x #22HD	8x #8	4x #8 93x #22HD

Polarizing Positions

Position	A°	B°	C°	D°
A	105	140	215	265
B	102	170	248	305
C	80	150	230	295
D	68	140	205	275
E	64	155	234	304
F	72	120	200	298

FEATURES

- Triple-start stub ACME mating thread
- El Ochito® Octaxial and hybrid High density #22HD arrangements for reduced size / weight and high-speed performance
- Aerospace-grade materials, construction, and performance

CONNECTOR CONSTRUCTION

- Shell and coupling nut: aluminum or stainless steel
- Contacts: copper alloy, gold plating
- Wire grommet: fluorosilicone
- Dielectric inserts: high grade rigid dielectric
- Peripheral seal: fluorosilicone
- Ground spring: copper alloy, nickel plating
- Contact retention clips: copper alloy
- Ratchet springs: stainless steel, passivated
- Retainer rings: stainless steel, passivated
- Clinch nuts: stainless steel, passivated

RECOMMENDED BACKSHELL

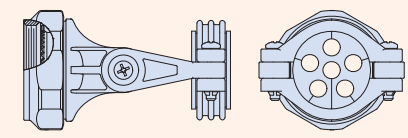

627-259
Swing-Arm 3-in-1 strain relief
with cable bushing (consult factory)

HIGH-SPEED Series 806 Mil-Aero Micro Miniature Circular Connectors

with El Ochito® octaxial contacts

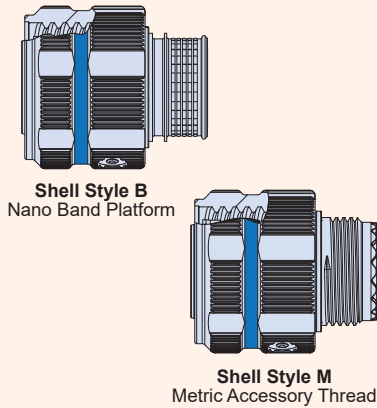

How To Order Series 806 El Ochito® Plugs						
SAMPLE PART NUMBER	806-012	-ME	18-3	S	M	A
Product	806-012 = Cable Plug					
Shell Material and Finish	ME = Aluminum, Electroless Nickel MT = Aluminum, Ni/PTFE ZR = Aluminum, Black Zinc-Nickel NF = Aluminum, Olive Drab Cadmium Z1 = Stainless Steel, Passivated					
Arrangement Number (Shell Size - Insert Arr.)	See Contact Arrangements Table					
Contact Type	Connector supplied without contacts A = Pin B = Socket					
Shell Style	M = Metric accessory threads B = Nano Band platform					
Polarizing Position	A B C D E F					

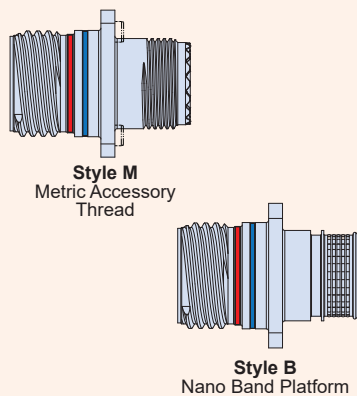

How To Order Series 806 El Ochito® Square Flange Receptacles						
SAMPLE PART NUMBER	806-013	-MT	18-21	P	B	C A
Product	806-013 = Panel Receptacle, Square Flange, Crimp					
Shell Material and Finish	ME = Aluminum, Electroless Nickel MT = Aluminum, Ni/PTFE ZR = Aluminum, Black Zinc-Nickel NF = Aluminum, Olive Drab Cadmium Z1 = Stainless Steel, Passivated					
Arrangement Number (Shell Size - Insert Arr.)	See Contact Arrangements Table					
Contact Type	Connector supplied without contacts A = Pin B = Socket					
Shell Style	M = Metric accessory threads B = Nano Band platform					
Mounting Hole Style	T = Thru holes C = Clinch nut, #4-40 (rear panel mounting)					
Polarizing Position	A B C D E F					

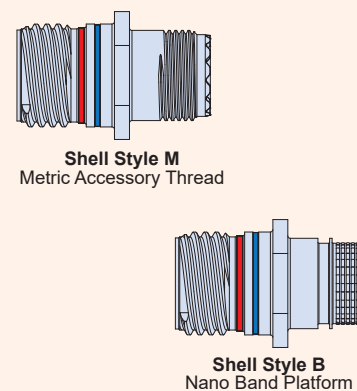

How To Order Series 806 El Ochito® In-Line Receptacles						
SAMPLE PART NUMBER	806-019	-MT	18-21	P	B	A
Product	806-019 = In-Line Receptacle					
Shell Material and Finish	ME = Aluminum, Electroless Nickel MT = Aluminum, Ni/PTFE ZR = Aluminum, Black Zinc-Nickel NF = Aluminum, Olive Drab Cadmium Z1 = Stainless Steel, Passivated					
Arrangement Number (Shell Size - Insert Arr.)	See Contact Arrangements Table					
Contact Type	Connector supplied without contacts A = Pin B = Socket					
Shell Style	M = Metric accessory threads B = Nano Band platform					
Polarizing Position	A B C D E F					

HIGH-SPEED Series 806 Mil-Aero Micro Miniature Circular Connectors

with El Ochito® octaxial contacts

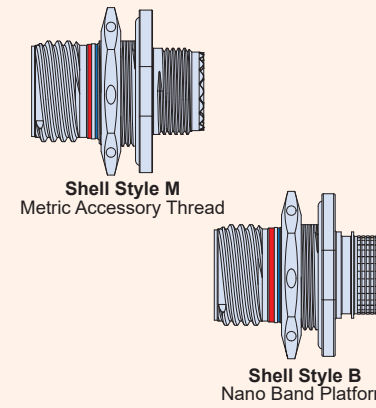

How To Order Series 806 El Ochito® Jam Nut Receptacles						
SAMPLE PART NUMBER	806-020	-MT	18-21	P	B	A
Product	806-020 = Jam Nut Receptacle					
Shell Material and Finish	ME = Aluminum, Electroless Nickel MT = Aluminum, Ni/PTFE ZR = Aluminum, Black Zinc-Nickel NF = Aluminum, Olive Drab Cadmium Z1 = Stainless Steel, Passivated					
Arrangement Number (Shell Size - Insert Arr.)	See Contact Arrangements Table					
Contact Type	Connector supplied without contacts A = Pin B = Socket					
Shell Style	M = Metric accessory threads B = Nano Band platform					
Polarizing Position	A B C D E F					

Table VI - Ochito Contact Positions

B = Blue, R = Red, W = White

SYM	El Ochito Contact Designator							
	A	B	C	D	E	F	G	H
E	W	W	W	W	W	W	W	W
E2	B	W	W	W	W	W	W	W
E3	R	W	W	W	W	W	W	W
E4	B	B	W	W	W	W	W	W
E5	R	B	W	W	W	W	W	W
E6	R	R	W	W	W	W	W	W
E7	B	B	B	W	W	W	W	W
E8	R	B	B	W	W	W	W	W
E9	R	R	B	W	W	W	W	W
E10	R	R	R	W	W	W	W	W
E11	B	B	B	B	W	W	W	W
E12	R	B	B	B	W	W	W	W
E13	R	R	B	B	W	W	W	W
E14	R	R	R	B	W	W	W	W
E15	R	R	R	R	W	W	W	W
E16	B	B	B	B	B	W	W	W
E17	R	B	B	B	B	W	W	W
E18	R	R	B	B	B	W	W	W
E19	R	R	R	B	B	W	W	W
E20	R	R	R	R	B	W	W	W
E21	R	R	R	R	R	W	W	W
E22	B	B	B	B	B	B	W	W
E23	R	B	B	B	B	B	W	W
E24	R	R	B	B	B	B	W	W
E25	R	R	R	B	B	B	W	W
E26	R	R	R	R	B	B	W	W
E27	R	R	R	R	R	B	W	W
E28	R	R	R	R	R	R	W	W
E29	B	B	B	B	B	B	B	W
E30	R	B	B	B	B	B	B	W
E31	R	R	B	B	B	B	B	W
E32	R	R	R	B	B	B	B	W
E33	R	R	R	R	B	B	B	W
E34	R	R	R	R	R	B	B	W
E35	R	R	R	R	R	R	B	W
E36	R	R	R	R	R	R	R	W
E37	B	B	B	B	B	B	B	B
E38	R	B	B	B	B	B	B	B
E39	R	R	B	B	B	B	B	B
E40	R	R	R	B	B	B	B	B
E41	R	R	R	R	B	B	B	B
E42	R	R	R	R	R	B	B	B
E43	R	R	R	R	R	R	B	B
E44	R	R	R	R	R	R	R	B
E45	R	R	R	R	R	R	R	R

How To Order Series 806 El Ochito® PCB Receptacles						
SAMPLE PART NUMBER	806-039	-MT	14	E	-	20A P A
Product	806-039 = Jam Nut 806-040 = Square-Flange					
Shell Material and Finish	ME = Aluminum, Electroless Nickel MT = Aluminum, Ni/PTFE ZR = Aluminum, Black Zinc-Nickel NF = Aluminum, Olive Drab Cadmium Z1 = Stainless Steel, Passivated					
Shell Size	10, 14, 16, 18, 20, 22, 24					
Contact Type	See Table VI					
Ground Option	G = Common Ground - = None					
Contact Arrangement Number	See Contact Arrangements Table					
Contact Gender	P = Pin S = Socket					
Panel Mount Thru-Hole Style	(for 806-040 square-flange only) T = Thru-Hole C = Clinch Nuts for Rear Panel Mount Omit for 806-039 Jam Nut					
Polarizing Position	A B C D E F					

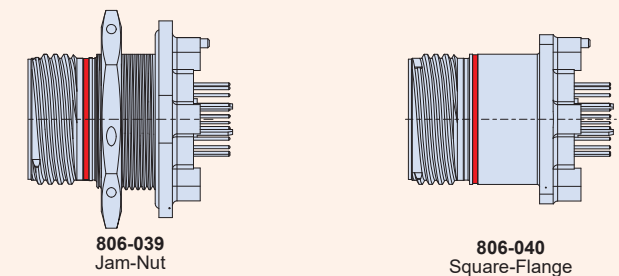



SuperNine® high-speed connectors with special inserts to accommodate El Ochito® octaxial contacts

- **Tooled and ready-to-ship high-speed and hybrid insert arrangement connectors for size #8 El Ochito shielded contacts. Arrangements for #8, #12, and #16 Coax, Twinax, and Quadrax also available**
- **Supported applications: 10/100/1G/10G BASE-T Ethernet, HDMI, DisplayPort, SATA, USB 3.0, 1553 databus and general RF or differential data transmission**

El Ochito®



Crimp contact and PC tail configurations

EL OCHITO CONTACT REFERENCE GUIDE

Contact Type	White, Type I	White, Type II	Blue, Type I	Red, Type I
Pin	858-003	858-005	858-028	858-030-01
Socket	858-004	858-006	858-029	858-031

RECOMMENDED BACKSHELL

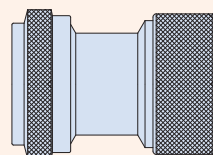

377HS121

Series 37 Aluminum Backshell for SuperNine plug and receptacle connectors. Straight, 45°, and 90° configurations available.

How To Order SuperNine® High-Speed Connectors with El Ochito contacts		-G6	NF	25	-	08	A	N	909XX
Sample Part Number	233-217								
Series / Basic Part No.	233-217 with Accessory Thread 233-224 Integral Banding Porch								
Connector Style	G6 Plug, EMI spring 05 in-line receptacle 07 jam-nut recpt. 00 wall mt. recpt., slotted holes CM wall mt. recpt., metric clinch nuts CS wall mt. recpt., std. clinch nuts DO wall mt. recpt., thru holes HM wall mt. recpt., metric helicoils HS wall mt. recpt., std. helicoils								
Material/Finish	NF = Cad/O.D. ME = Electroless Nickel MT = Nickel PTFE ZR = Black Zinc Nickel								
Shell Size	9, 11, 13, 17, 19, 21, 23, 25								
Ground Option	G = Common Ground - = None								
Insert Arrangement	See insert arrangement tables, next pages								
Insert Designator	A = Pin insert, less contacts B = Socket insert, less contacts								
Alternate Polarization*	A, B, C, D, E, N = Normal (IAW MIL-DTL-38999 Series III)								
Optional Mod Code	909XX = Supplies connector with contacts								

How To Order SuperNine® High-Speed Quick-Disconnect Connectors with El Ochito contacts		-G6	ME	25	-	8	E	A	N	-909EP
Sample Part Number	233-260									
Series / Basic Part No.	233-260 High-Speed Quick Disconnect									
Connector Style	G6 = Quick Disconnect Plug									
Material/Finish	NF = Cad/O.D. ME = Electroless Nickel MT = Nickel PTFE ZR = Black Zinc Nickel Z1 = SST, Passivated									
Shell Size	9, 11, 17, 19, 21, 23, 25									
Ground Option	G = Common Ground - = None; See Note 8									
Insert Arrangement	See insert arrangement tables, next pages									
Lanyard Length Code	consult factory or SuperNine catalog									
Contact Style	A = Pin Less Contact B = Socket Less Contact									
Alternate Polarization*	A, B, C, D, E, N = Normal (IAW MIL-DTL-38999 Series III)									
Optional Mod Code	909ES = Connector with El Ochito Socket contacts 909EP Connector with El Ochito Pin contacts									

How To Order SuperNine® High-Speed PC-Tail Threaded Standoff Receptacles with El Ochito contacts		-00	M	17	E	-	02	S	N
Sample Part Number	233-218								
Series / Basic Part No.	High-Speed PC tail wall mount receptacles, threaded standoffs								
Connector Style	07 jam-nut 00 wall-mount, slotted holes CM wall mt., metric clinch nuts CS wall mt., std. clinch nuts HM wall mt., metric helicoils HS wall mt., std. helicoils								
Material/Finish	NF = Cad/O.D. ME = Electroless Nickel MT = Nickel PTFE ZR = Black Zinc Nickel								
Shell Size	9, 11, 13, 15, 17, 19, 21, 23, 25								
Contact Type	E = El Ochito ⁷								
Ground Option	G = Common Ground - = None								
Insert Arrangement	See insert arrangement tables, next pages								
Contact Style	P = Pin, PC Tail S = Socket, PC Tail								
Alternate Polarization*	A, B, C, D, E, N = Normal (IAW MIL-DTL-38999 Series III)								

How To Order SuperNine® High-Speed Wall Mount Receptacles with El Ochito contacts		-00	ME	17	E	-	02	S	N
Sample Part Number	233-225								
Series / Basic Part	SuperNine® High-Speed, dual flange wall-mount receptacle								
Connector Style*	07 jam-nut 00 wall-mount, slotted holes/stand off, std. threads 10 Wall-mount, slotted holes/stand off, metric threads CM wall-mount, metric clinch nuts CS wall mount, std. clinch nuts HM wall mount, metric helicoils HS wall mount, std. helicoils								
Material/Finish	NF = Cad/O.D. ME = Electroless Nickel MT = Nickel PTFE ZR = Black Zinc Nickel								
Shell Size	9, 11, 13, 17, 19, 21, 23, 25								
Contact Type	E = El Ochito								
Ground Option	G = Common Ground - = None								
Insert Arrangement	Per MIL-STD-1560, see page C-5 and C-6								
Contact Style	P = Pin, PC Tail S = Socket, PC Tail								
Alternate Polarization*	A, B, C, D, E, N = Normal (IAW MIL-DTL-38999 Series III)								

SERIES 23
SuperNine® High-speed connectors



High-speed size #8 and hybrid insert arrangements
(note: size #8 cavities keyed for contact polarization)

SERIES 23
SuperNine® High-speed connectors



High-speed size #8 and hybrid insert arrangements
(note: size #8 cavities keyed for contact polarization)

Contact Legend
#23 ● #22D ○
#16 ⊕ #20 ⊖
#12 ◐ #8 ◑

Insert Arrangement	9G5*	11-1	13-14	17-2
No. of Contacts	1x #8	1x #8	1x #8 14x #23	1x #8 38x #22D

*Only available with ground plane option

Contact Legend
#23 ● #22D ○
#16 ⊕ #20 ⊖
#12 ◐ #8 ◑

Insert Arrangement	17-22	17-60	17-75
No. of Contacts	2x #8 2x #12	2x #8 8x #22	2x #8

Contact Legend
#23 ● #22D ○
#16 ⊕ #20 ⊖
#12 ◐ #8 ◑

Insert Arrangement	19-4	19-17	19-18
No. of Contacts	4x #8	2x #8 4x #16 1x #20 10x #22D	4x #8 14x #22D

Contact Legend
#23 ● #22D ○
#16 ⊕ #20 ⊖
#12 ◐ #8 ◑

Insert Arrangement	21-75	23-5	23-6
No. of Contacts and Size	4x #8	5x #8	6x #8

Contact Legend
#23 ● #22D ○
#16 ⊕ #20 ⊖
#12 ◐ #8 ◑

Insert Arrangement	25-7	25-8	25-17
No. of Contacts and Size	2x #8 97x #22	8x #8	6x #8 36x #22

Contact Legend
#23 ● #22D ○
#16 ⊕ #20 ⊖
#12 ◐ #8 ◑

Insert Arrangement	25-20	25-26
No. of Contacts and Size	3x #8 4x #12 13x #16 10x #20	4x #8 5x #12 16x #20

Contact Legend
#23 ● #22D ○
#16 ⊕ #20 ⊖
#12 ◐ #8 ◑

Insert Arrangement	25-41	25-46
No. of Contacts and Size	3x #8 2x #12 11x #16 3x #20 22x #22D	2x #8 4x #16 40x #20

10G HIGH-SPEED CONTACT MODULES FOR GLENAIR SIGNATURE SERIES CONNECTORS



SPEEDMASTER™
High-speed 10G connection system for Glenair SuperNine, Mighty Mouse, and HiPer-D connectors

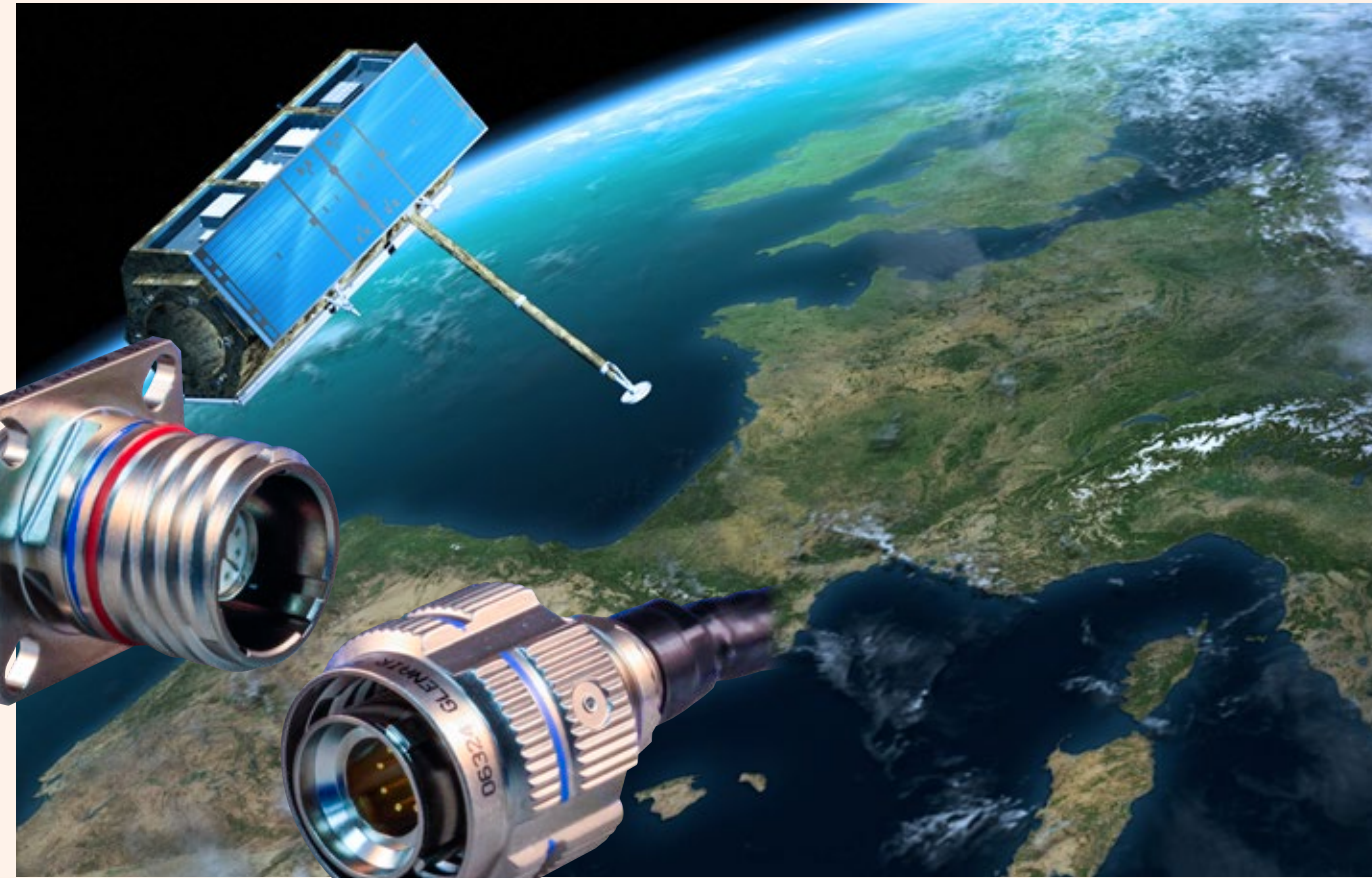

SpeedMaster™ is a dedicated contact module and insert package for SuperNine®, Mighty Mouse, and HiPer-D connectors. Optimized for high-speed Cat 6A Ethernet, the SpeedMaster™ 10G system offers industry-leading NEXT, return loss and insertion loss performance

- Utilizes aerospace industry standard #22D contacts, tools, and widely available Ethernet flight cable
- Significant weight reduction compared to Quadrax solutions (reduces cable requirement by half)



SpeedMaster Mighty Mouse Locking Push/Pull Connectors



SpeedMaster HiPer-D Rectangular (M24308 intermountable)



SpeedMaster SuperNine "better than QPL" connectors

SpeedMaster™ High-Speed 10G Connection System



for Glenair SuperNine, Mighty Mouse, and HiPer-D connectors

SPEEDMASTER 10G NEXT-GENERATION HIGH-SPEED CONNECTION SYSTEM

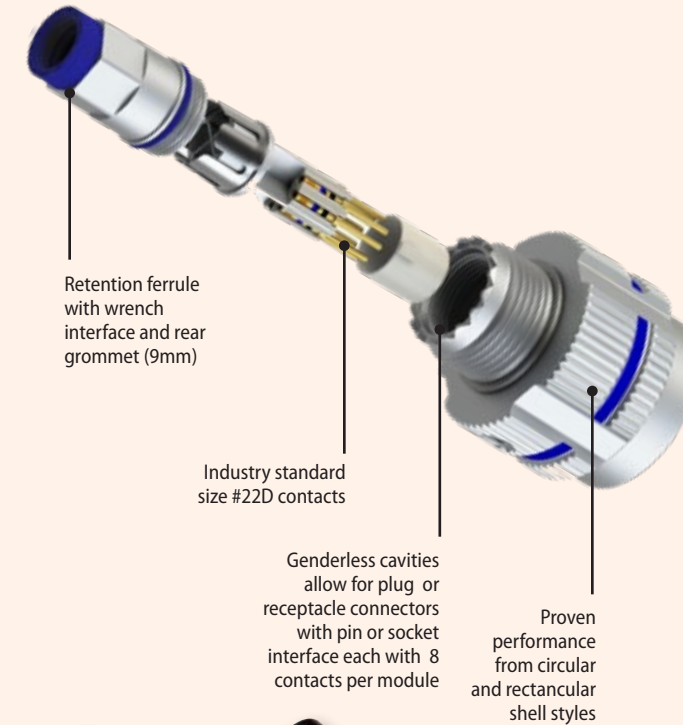

The SpeedMaster Difference

SpeedMaster, the high-speed multi-contact solution for the Mighty Mouse, HiPer-D and SuperNine 38999 type family of connectors. Each SpeedMaster module consists of 4 pairs of pins or sockets incorporating industry standard size 22D contacts to provide 10G performance. Each module is individually shielded within the shell, and retained in place with a threaded ferrule. Additionally, module cavities are genderless allowing pin or socket interface for plugs or receptacles. Glenair offers these SpeedMaster contacts in 3 connector packages, including our small form factor Mighty Mouse Series 824 Locking Push/Pull, HiPer-D (M24308) hi-performance rectangular D-Sub, and our 38999 type "better than QPL" connectors allowing you to adapt and fit your application needs. These features result in a two fold benefit. An easily removable and repairable, shielded high performance contact packaged within robust industry standard connectors, helping to reduce network downtime and providing a connectorized solution to improve the overall network function and performance. Meet the demand for the next generation Cat 6A networks with SpeedMaster, the next generation contact system from Glenair.



SpeedMaster 10G modular inserts are available for Series 23 SuperNine – 38999, Series 80 Mighty Mouse – Locking Push / Pull and Series 28 HiPer-D – M24308 rectangular D-Sub connectors



The SpeedMaster 10G is optimized for high-speed Ethernet performance and incorporates standard M39029 #22D contacts isolated for superior NEXT, return loss and insertion loss performance

Cable Size			
Cable Size	Cable Ø	Cable Size	Cable Ø
1	.280 (7.11)	5	.240 (6.10)
2	.270 (6.86)	6	.230 (5.84)
3	.260 (6.60)	7	.220 (5.59)
4	.250 (6.35)		

SpeedMaster™ High-Speed Cable					
Cable P/N	Cabel Category	Cable Construction	Wire Gage	Cable Dia.	Assembly Instruction
963-003-24	Cat 6A	SF/UTP	24	.280	AI85082
963-003-26	Cat 6A	SF/UTP	26	.220	
963-037	Cat 6A	SF/UTP	24	.260	
963-033-24	CAT 6A	S/FTP	24	.260	
933-033-26	CAT 6A	S/FTP	26	.220	

SpeedMaster™ Pre-wired 10G high-speed contacts

858-102 10GBase-T Cat 6A Contacts



Pre-wired SpeedMaster assemblies are 100% tested and ready for use. Compatible with Glenair Series 80 Mighty Mouse, Series 28 HiPer-D or Series 23 SuperNine connectors with keyed size #8 cavities, these assemblies are available with three termination options: single-ended, SpeedMaster contacts on both ends, or with an RJ45 plug on one end. Contacts are wired per the guidelines of ARINC 664 Part 2 Appendix N.

Connector Compatibility

- Glenair 824-009 and -010 Mighty Mouse
- Glenair 280-098 thru -103 HiPer-D
- Glenair 233-219, 233-220 SuperNine

Contact Positions

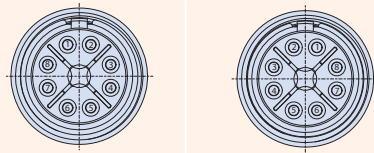

Mating Face of Pin Contacts Mating Face of Socket Contacts

Part Number Development					
Sample Part Number	8575-0001	-A	C	-1	-12
Product	8575-0001				
End A Contact Type	-A = 858-101 SpeedMaster pin -B = 858-100 SpeedMaster socket				
End B Contact/Connector	A = SpeedMaster pin B = SpeedMaster socket C = RJ45 plug N = No connector				
Cable Option	-1 = 963-003-24 -5 = 963-033-24 -2 = 963-003-26 -6 = 963-033-26 -4 = 963-037				
Length	Overall length in inches				

8575-0001 SPEEDMASTER™ WIRING DIAGRAMS

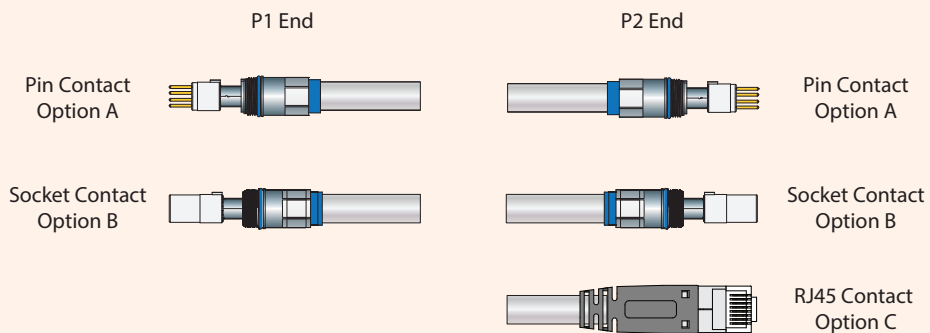
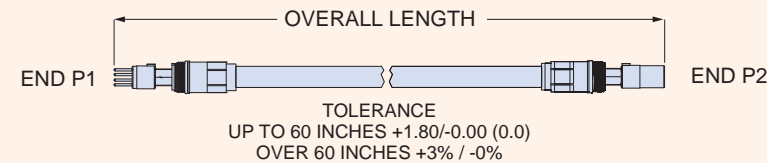
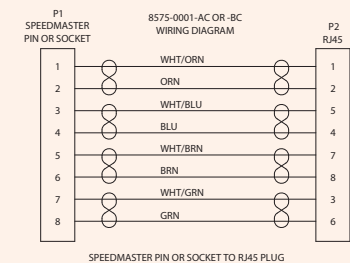
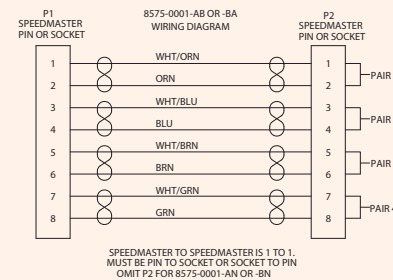

Specifications

- Operating temperature: -65°C. to +200°C. (SpeedMaster) or -40°C. to +85°C (RJ45); cable dependent
- Meets EIA/TIA 568C.2-10 and IEC 60603-7-51 Cat 6A 500 MHz
- Characteristic Impedance: 100 ohms
- Insulation resistance: 200 megohms min.
- Durability: 500 mating cycles

SpeedMaster™ Available connector packaging



MIGHTY MOUSE 824 LOCKING PUSH-PULL



- Quick-disconnect coupling
- Audible, visual, and tactile full-mate indicators

Available connector configurations

- 824-009-06 Plug
- 824-010-01 In-line Receptacle
- 824-010-00 Front Panel Mount, Jam Nut Receptacle
- 824-010-07 Rear Panel Mount, Jam Nut Receptacle

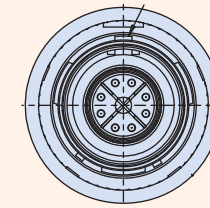

Single Contact Module Insert Arrangement
Ideally suited for CAT5E or CAT6A Ethernet applications

HIPER-D M24308 INTERMOUNTABLE

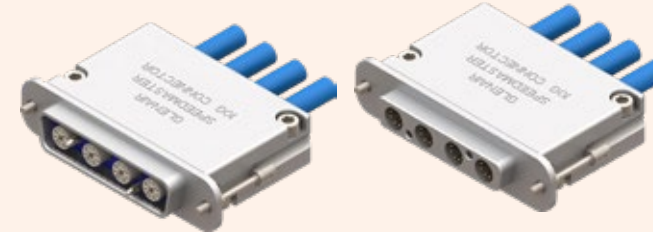

- Advanced temperature, vibration and EMC/ electrical performance
- Rugged machined one-piece shell

Series 28 In-Line Connectors

- 280-101M Plug
- 280-098F Receptacle

Series 28 Rear Panel Mount Connectors

- 280-102M Plug
- 280-099F Receptacle

Series 28 Float Mount Connectors

- 280-103M Plug
- 280-100F Receptacle

SpeedMaster HiPer-D Insert Arrangements



SUPERNINE D38999 SERIES III TYPE



- Advanced performance, "better than QPL" D38999 Series III type bodies and shells
- Optimized for SpeedMaster contact modules

233-219 SpeedMaster SuperNine connectors

- G6 = Plug 38999/26
- 05 = Receptacle, in-line
- 07 = Receptacle, jam-nut 38999/24
- 00 = Receptacle, wall mount 38999/20
- CM = Receptacle, wall mount, metric clinch nuts
- CS = Receptacle, wall mount, standard clinch nuts
- DO = Receptacle, wall mount, thru holes
- HM = Receptacle, wall mount, metric helicoils
- HS = Receptacle, wall mount, standard helicoils
- TO = Receptacle, wall mount, tapped holes

233-220 SpeedMaster SuperNine PC Tail connectors

- 00 = Wall mount receptacle with slotted holes, standard standoff threads
- 10 = Wall mount receptacle with slotted holes, metric standoff threads
- CM = Wall mount receptacle with metric clinch nuts
- CS = Wall mount receptacle with standard clinch nuts
- HM = Wall mount receptacle with metric helicoils
- HS = Wall mount receptacle with standard helicoils
- 07 = Jam-nut receptacle

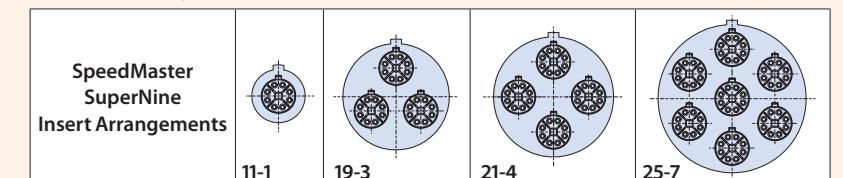

RECOMMENDED BACKSHELL

377NS119 Aluminum Alloy Backshell

ETHERNET-READY
HIGH-SPEED
INDUSTRIAL-
STRENGTH



The faster ruggedized 4/8 pole interconnect system for Ethernet data applications



Glenair series ITH connectors with Ethernet-ready Octobyte™ contacts are available for harsh-environment mass transit applications that depend on sealed environmental (IP67) connector performance. Octobyte contacts, packaged in ruggedized ITH reverse-bayonet connectors, deliver both dedicated Ethernet datalink as well as mixed serial databus and power for high-speed data applications

Octobyte™ contacts are vibration resistant and designed to work with Ethernet cables from CAT 5 to CAT 7A, MVB-WTB, and RG58 Coax. Reverse-bayonet ITH series connectors with Octobyte™ contacts are easy and fast to assemble and deliver reliable locking performance in severe vibration and shock applications.



Tested for compliance IAW EN50173-1 standards for CAT5E and CAT7. Proven performance in numerous rail applications (consult factory for references)

- For harsh-environment transit, industrial, or marine/subsea applications
- RF Coax applications (RG58 and RG59U cables)
- High-speed interconnect solution for audio, video, and digital displays
- Qualified for use in safety systems, sensors, detection devices, and control panels
- Tested in accordance with:
ISO F0 STP: CAT 7A
EN50173-1 F600-STP: CAT 7
EN50173-1 D STP: CAT 5E

OCTOBYTE™
The faster ruggedized Ethernet
interconnect solution



OCTOBYTE CONTACTS FOR ETHERNET CAT 5 • CAT 6 • CAT 7 • COAX • MVB-WBT

How To Order Octobyte contacts	
Sample Part Number	Q 0 8 P -A B1 -XXX -7A
Product Series	Octobyte contacts
Contact Size	0 = contact size 0
Number of Contacts	8 = 8 poles 4 = 4 poles CX = Coax
Contact Gender	P = Male S = Female
Cable O.D. Range/ Coax Cable Type	A = O.D. 6-7 B = O.D. 7-8 C = O.D. 8-9 RG58 = 50 Ohm RG59U = 75 Ohm [Coax only]
Plating	B1 = gold plating
Alternative Color (Cat 7A only)	G14 = Black G14GN = Green G14GY = Grey G14R = Red G14Y = Yellow Omit for standard
Ethernet	7A = Cat 7A AD = Ethernet MVB - WBT Contacts Omit for Cat 5



SERIES ITH CONNECTORS FOR OCTOBYTE CONTACTS

Reverse bayonet-lock connectors

Rugged environmental performance – the perfect Octobyte packaging solution



Dozens of contact arrangements available including hybrid Octobyte, power, and signal.

- Rugged MIL-DTL-5015 type design with fast reverse bayonet coupling
- Rigid dielectric inserts with contact retention clips
- Positive lock technology provides reliable vibration and shock resistance
- Proven performance in even the most rugged applications
- Conforms to the European VG 95234 standard, French (NFF 61030) and British (BS 6853) electrical standards and EEC compliance directives
- Threaded coupling version available, contact factory for ordering information

Ethernet-ready Octobyte solutions for rail and transit applications are available as discrete contacts, packaged in rugged reverse-bayonet ITH series connectors, or as turnkey inside-the-box or environmental cable assemblies, tested and ready for immediate use.



Available flop-lid protective cover

RadGrip rubber-covered coupling nuts available in a wide range of colors including safety red



SUPER ITS - ITH OCTOBYTE CONNECTORS

Precision machined connectors with 4/8 pole Octobyte contacts provide high-speed Ethernet connectivity for extreme environmental exposure and corrosion resistance typically needed in rail, mining, and other industrial applications. Convenient reverse bayonet mating provides easy intermateability while the locking three pin bayonet coupler prevents the connector from demating under high shock and high vibration conditions. Accessory thread for attachment of backshells and adapters.

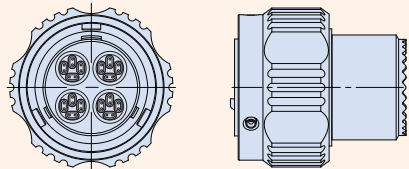

03 - Plug

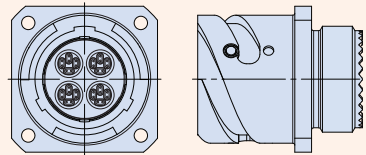

030 - Rear Panel Mount Wall
Mount Receptacle

How To Order	
Sample Part Number:	ITH 030 A 5C 32Q4 S B0 N0 F6
Series	ITH
Contact Size	030 = Rear Panel Mount Wall Mount Receptacle 06 = Straight Plug
Environmental	A = Non environmental R = Environmental
Number of Keys	5C = 5 keys
Insert Arrangements	18-Q1, 32-Q4, 36-Q5, 40-Q7
Contact Gender	P = Pin contacts (male) S = Socket contacts (female)
Connector less contact	B0 = contact not supplied (order the contact separately)
Accessory	N0 = without Backshell. Please consult the factory
Plating	F6 = Electrodeposited black paint (cataphoresis), RoHS compliant F7 = Black Zinc Nickel, RoHS compliant

FRONT VIEW RECEPTACLE CONNECTORS

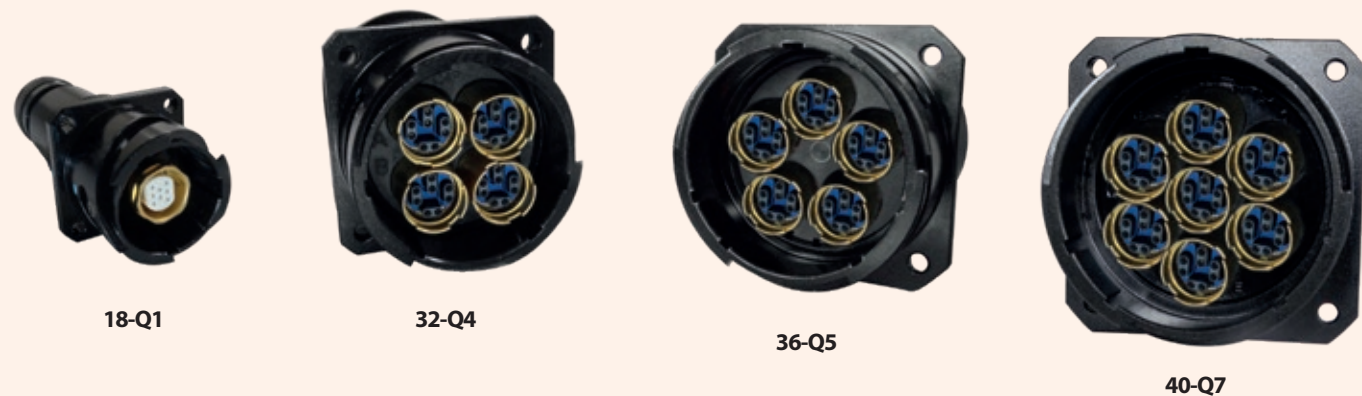

18-Q1

32-Q4

36-Q5

40-Q7

SERIES ITS - ITH OCTOBYTE CONNECTORS

Precision machined connectors with 4/8 pole Octobyte, high-speed Ethernet contacts and power contacts provide both network connectivity and power distribution in one connector. Designed for extreme environmental exposure and corrosion resistance typically needed in rail, mining, and other industrial applications. Convenient reverse bayonet mating provides easy intermateability while the locking three pin bayonet coupler prevents the connector from demating under high shock and high vibration conditions. Accessory thread for attachment of backshells and adapters.

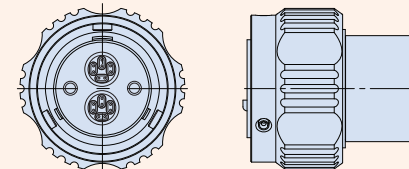

03 - Plug

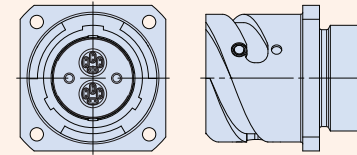

030 - Rear Panel Mount Wall
Mount Receptacle

How To Order	
Sample Part Number:	ITH 030 A 5C 28-OB4 S B0 N0 F6
Series	ITH
Contact Size	030 = Rear Panel Mount Wall Mount Receptacle 06 = Straight Plug
Environmental	A = Non environmental R = Environmental
Number of Keys	5C = 5 keys
Insert Arrangements	28-OB4, 36-OB7
Contact Gender	P = Pin contacts (male) S = Socket contacts (female)
Connector less contact	B0 = contact not supplied (order the contact separately)
Accessory	N0 = without Backshell. Please consult the factory
Plating	F6 = Electrodeposited black paint (cataphoresis), RoHS compliant F7 = Black Zinc Nickel, RoHS compliant

FRONT VIEW PLUG CONNECTORS



28-OB4
2 OCTOBYTE
2 SIZE 8 CONTACTS

36-OB7
3 OCTOBYTE
4 SIZE 8 CONTACTS

RUGGEDIZED
RJ45 / USB
FIELD
CONNECTORS



SuperSeal RJ45 and USB field connectors. Now available for USB SuperSpeed 3.0



Military-grade, ruggedized field connectors that deliver improved environmental sealing, EMI/RFI grounding, and a broader range of wire termination options for RJ45 and USB—now for SuperSpeed 3.0



Available ruggedized memory stick 32GB, 64GB, and 128GB versions

- New SuperSpeed USB 3.0 protocol support
- Superior sealing—IP67 unmated—for complete system protection against water, sand and dust
- Highly durable SuperSeal™ insert design, provides enhanced operating temperature, increased life-cycle, and rugged vibration and shock performance
- Crimp, solder-cup, PC tail and cable assemblies

SuperSeal High-Speed Ruggedized RJ45/USB connectors and cables



SuperSpeed USB 3.0

NEW SUPERSPEED USB 3.0 RUGGEDIZED FIELD CONNECTORS



TURNKEY SUPERSPEED USB 3.0 CABLE ASSEMBLIES AND JUMPERS



Glenair SuperNine USB 3.0 cable jumpers, SuperSeal to standard USB Type A and Micro-B connectors

SuperSeal USB 3.0 connectors are available as turnkey cable jumpers. Rugged field connector styles—including plug, wall mount and jam-nut receptacles—may be cabled with commercial 3.0 connector types including male Type A, female Type A, and male Micro B. Assemblies may be ordered with straight or right angle cable exit. In addition, the USB 3.0 insert may be ordered in horizontal or vertical orientation to provide protection against mis-mating. Maximum overall length is 15 feet.

SUPPORTED USB 3.0 CONNECTOR TYPES

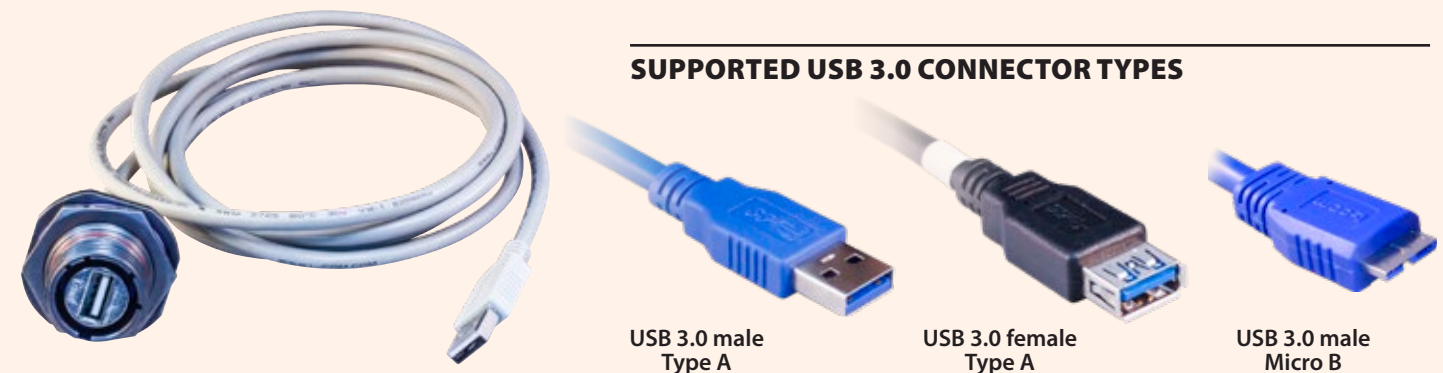

USB ORIENTATION OPTIONS

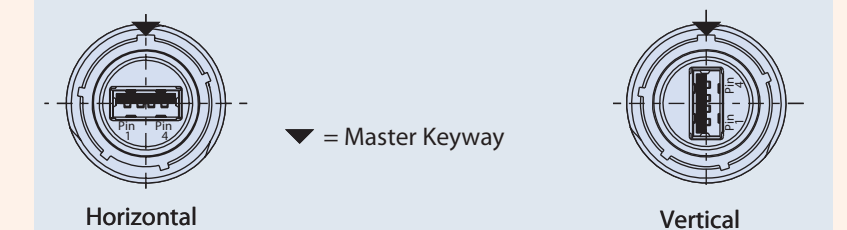

SuperSeal High-Speed Ruggedized RJ45/USB connectors and cables

Available connector packaging



SuperSeal High-Speed Ruggedized RJ45/USB connectors and cables

Available connector packaging



AVAILABLE TERMINATION OPTIONS



Solder Cup



PC tail



Crimp Contact



Jack-to-Jack



EMI Filtered



Quadrax



MIL-STD-1560 Arrangements



Turnkey Cordsets



SuperSeal™ MIL-DTL-38999 Series III Type RJ45 Connectors and Cordsets plus NEW Transient Voltage Suppression Solutions



SuperSeal™ MIL-DTL-Series 39999 Series III Type USB 2.0 Connectors and Cordsets



ITS SuperSeal™ (5015 Intermountable) Reverse-Bayonet RJ45 Connectors



ITS SuperSeal™ (5015 Intermountable) Reverse-Bayonet USB 2.0 Connectors



IPT SuperSeal™ MIL-DTL-26482 Type Bayonet RJ45 Connectors



IPT SuperSeal™ MIL-DTL-26482 Type Bayonet USB Connectors



SuperSeal™ MIL-DTL-28840 Type RJ12/RJ45 and USB Shipboard Connectors



SuperSeal™ Series 801, 804 and 805 Mighty Mouse Micro USB 2.0 Connectors

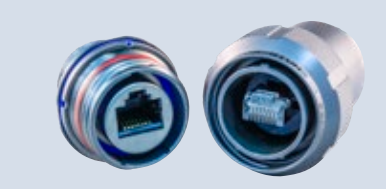

SuperSeal™ Series 801, 804 and 805 Mighty Mouse RJ45 Connectors



SuperSeal™ Series 801, 804 and 805 Mighty Mouse Standard USB 2.0 Connectors

HIGH-SPEED
VERSALINK™
DIFFERENTIAL
TWINAX



Ultra Miniature Micro-D
Connectors with High-Speed VersaLink
Contact Technology



Innovative differential Twinax contact technology in ruggedized, high-density mil-spec connector packaging

High-speed serial data protocols (USB 3.1 Gen2, USB-C, SATA, PCIe, DisplayPort, and HDMI) all have transmission rates in the 10Gb/s+ range for each data pair. In order to provide truly high-speed signal integrity for these bandwidth-dependent protocols, Glenair has invented a new contact technology called VersaLink™ which delivers outstanding impedance matching and cross-talk isolation at both the cable-to-connector interface, as well as between connector and board. VersaLink is a highly-engineered differential Twinax contact module that may be packaged in a wide range of both circular and rectangular connector formats such as the MIL-DTL-83513 Micro-D. This high-density package solution provides mating reliability, ruggedness, signal integrity, and deployment simplicity.

Data-intensive servers, computers and peripheral devices in mission-critical applications require a new generation of shielded contact technology and tried-and-true connector package performance. Both are exquisitely realized in the VersaLink Micro-D.

- VersaLink: shielded differential Twinax interconnect solution
- Signature Glenair design intermountable in standard Micro-D footprints
- Higher speed and density than mil-spec style Twinax solutions
- Individually shielded pairs result in virtually zero cross talk
- Hybrid arrangements with VersaLink contact modules and standard Micro-D inserts for signal and power

HIGH-SPEED VersaLink™ Micro-D

Military-standard Micro-D connectors with “zero crosstalk”
VersaLink™ Twinax contact modules



CONNECTOR CONFIGURATIONS

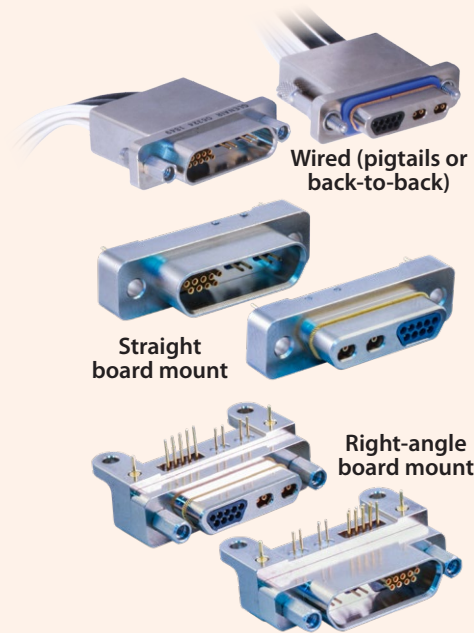

EMI SHIELDING AND ENVIRONMENTAL SEALING

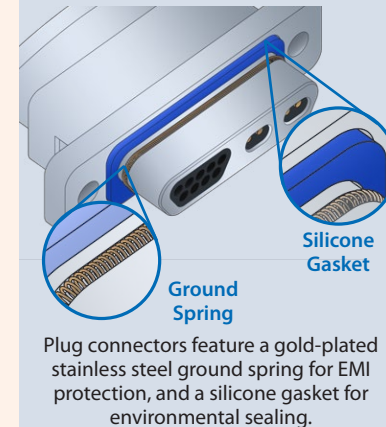

SUPPORTED HIGH-SPEED PROTOCOLS AND APPLICATIONS

Networking Protocols	Peripheral and Display Protocols	
10Gb Ethernet 40Gb Ethernet	DVI (Digital Visual Interface) HDMI 2.0 (High-Definition Multimedia Interface) DisplayPort 1.2 SATA 3 (Serial AT Attachment)	USB 3.0 (Universal Serial Bus) USB 3.1 Type C (Universal Serial Bus) USB 3.2 (Universal Serial Bus) PCIe 3 (Peripheral Component Interconnect)

CONTACT ARRANGEMENTS

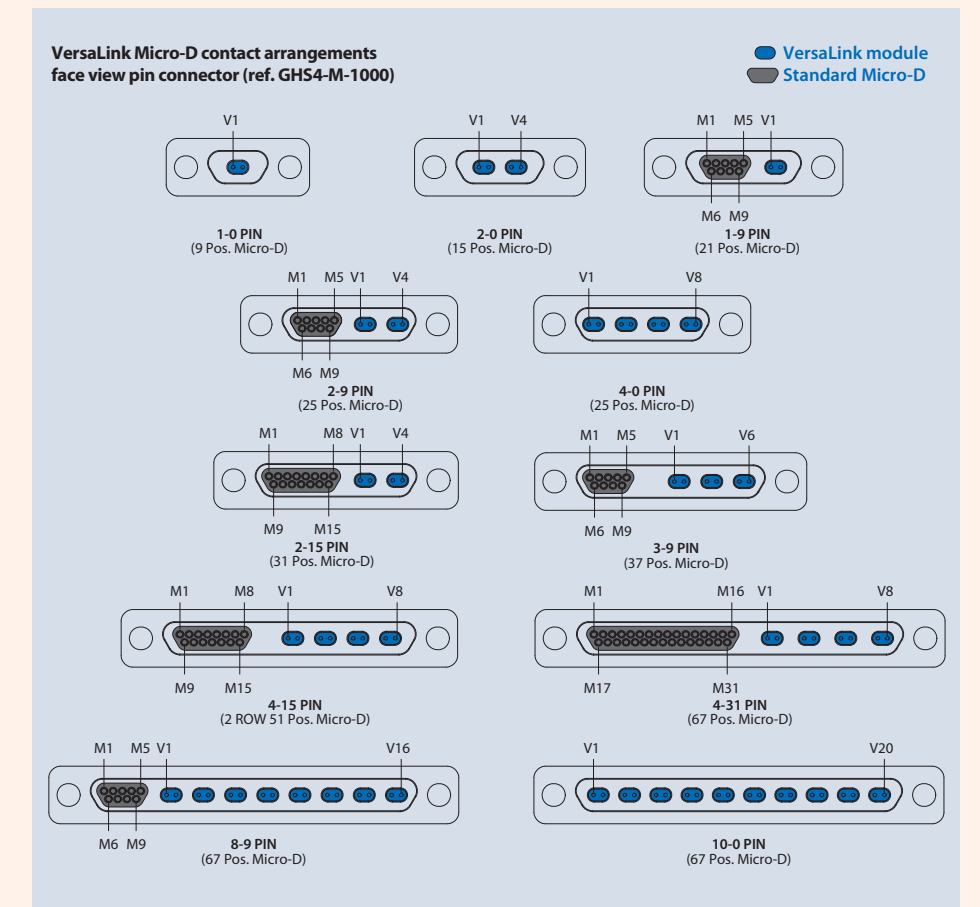

MATERIALS AND FINISHES

Connector Shell: Aluminum Alloy 6061
Insulator (V): Rigid Dielectric. Insulator (M): Liquid Crystal Polymer (LCP) or Polyphenylene Sulfide (PPS)
Flange Seal: Fluorosilicone Rubber, Blue
Pin Contact: Copper Alloy, Gold over Nickel Plating
Socket Contact: Copper Alloy, Gold over Nickel Plating
Ground Spring: Stainless Steel, Gold Plating
Ground Pin: Copper Alloy, Gold over Nickel Plating
Hardware: 300 Series Stainless Steel, Passivated
Encapsulant: Epoxy Resin Hysol EE4215

PERFORMANCE SPECIFICATIONS

Current Rating: 3 Amp (Micro-D pins)
DWV (Contact M): 600 VAC Sea Level
Insulation Resistance (Contact M): 5000 Megohms Minimum
Contact Resistance (Contact M): 8 Milliohms Maximum
Low Level Contact Resistance: 32 Milliohms Maximum
Operating Temperature: -55°C To 125°C
Mating Force (Contact M): (10 Ounces) X (# Of Contacts)
Mating Force (Contact V): (5 Ounces) X (# Of Contacts)

How To Order VersaLink Micro-D Wired Connectors												
Sample Part Number	GHS4-M	2	L-	2-9	P	A	6	J	I	-18	K	N
Series	GHS4-M = Glenair VersaLink Micro-D											
Shell Finish	2 = Nickel 5 = Gold											
Insulator Material	L = LCP or PPS											
Contact Layout (V-M)	1-0, 2-0, 1-9, 2-9, 4-0, 2-15, 3-9, 4-15, 4-31, 8-9, 10-0											
Contact Type ¹	P = Pin (Single-End Plug) S = Socket (Single-End Receptacle) GP = Double-End Cable, Pin Connectors Both Ends GS = Double-End Cable, Socket Connectors Both Ends CS = Double-End Cable, Pin and Socket [designation is for Micro-D contacts, see note 1 below]											
VersaLink Cable Type	A = Glenair Cable 963-043-26 (100 Ohm, +105°C Max)											
Discrete Wire Gage (AWG) ²	4 = #24 6 = #26 8 = #28 0 = #30 (J Wire Type Only)											
Discrete Wire Type ²	K = M22759/11 600 VRMS Teflon (TFE) J = M22759-33 600 VRMS Modified Cross-Linked Tefzel (ETFE) E = NEMA HP3-EB 600 VRMS Type E M16878/4 (TFE)											
Discrete Wire Color ²	1 = White 5 = Color-Coded Stripes per MIL-STD-681 7 = Ten Color Repeating											
Wire Length	Wire Length in Inches, 6 Inch Minimum											
Hardware ³	P, M, M1, S, S1, L, K (See Mounting Hardware Designations table below)											
Shield and Jacket Option	X - ArmorLite Braided Microfilament Stainless Steel shield with E-CTFE Halar "Expando" Jacket W - ArmorLite Braided Microfilament Stainless Steel shield Z - 75% Braided AmberStrand shield with E-CTFE Halar "Expando" Jacket V - 75% Braided AmberStrand shield T - 100% Braided AmberStrand shield with E-CTFE Halar "Expando" Jacket S - 100% Braided AmberStrand shield C - Braided shield (Nickel Over Copper) with E-CTFE Halar "Expando" Jacket A - Braided shield (Nickel over Copper) N - No Shield, No Jacket (customer to install)											

1 - Plug connector uses Pin Micro-D contacts and Socket VersaLink contacts. Receptacle uses Socket Micro-D contacts and Pin VersaLink contacts.
GP and GS cable ends rotated 180° out of phase due to connector symmetry.
2 - Omit wire information for VersaLink-only contact layouts (1-0, 2-0, 4-0, 10-0)
3 - Hardware is always required to ensure connector pair is fully mated when installed

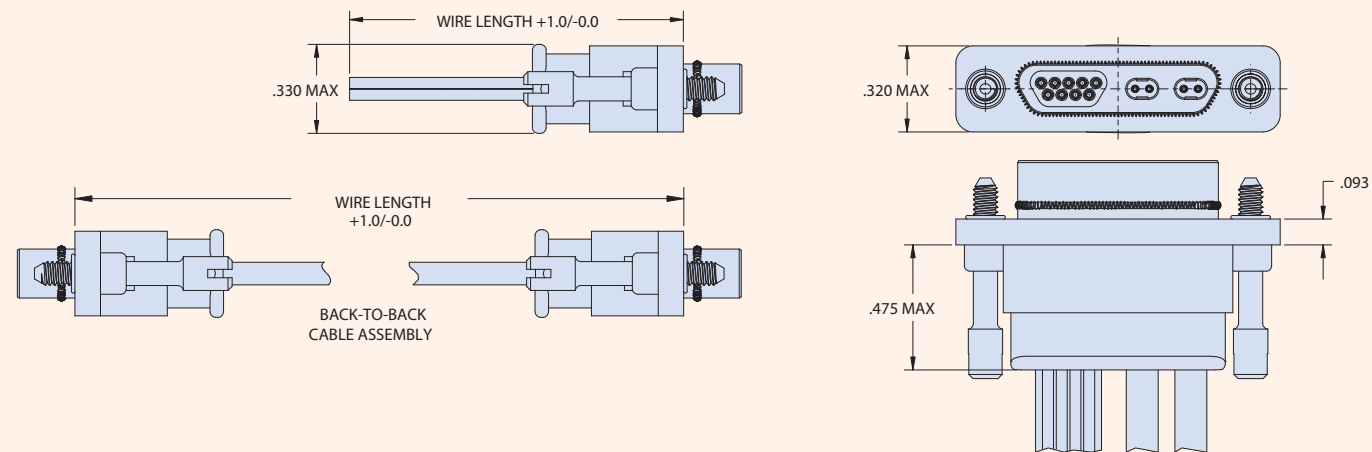

Mounting Hardware Designations						
P Jackpost	M Hex Head Jackscrew	M1 Hex Head Jackscrew, Extended	S Slot Head Jackscrew	S1 Slot Head Jackscrew, Extended	L Hex Head Jackscrew, Non-Removable	K Slot Head Jackscrew, Non-Removable Extended

How To Order VersaLink Micro-D Straight Board-Mount Connectors										
Sample Part Number	GVLM	2	L-	2-9	P	BS	PN	-110		
Series	GVLM = Glenair VersaLink Micro-D									
Shell Finish	2 = Nickel 5 = Gold									
Insulator Material	L = LCP or PPS									
Contact Layout (V-M)	1-0, 2-0, 1-9, 2-9, 4-0, 2-15, 3-9, 4-15, 4-31, 8-9, 10-0									
Contact Type ¹	P = Pin (Plug) S = Socket (Receptacle) [designation is for Micro-D contacts, see note 1 below]									
Termination Type	BS = Board Straight									
Hardware ²	PN = Extended Jackpost with Hex Nut and Lockwasher									
PC Tail Length ³	-.080, -.110, -.140 (Length in Inches ±.015)									

1 - Plug connector uses Pin Micro-D contacts and Socket VersaLink contacts. Receptacle uses Socket Micro-D contacts and Pin VersaLink contacts
2 - Hardware is always required to ensure connector pair is fully mated when installed 3 - PC Tails solder-dipped in 60/40 Tin-Lead solder

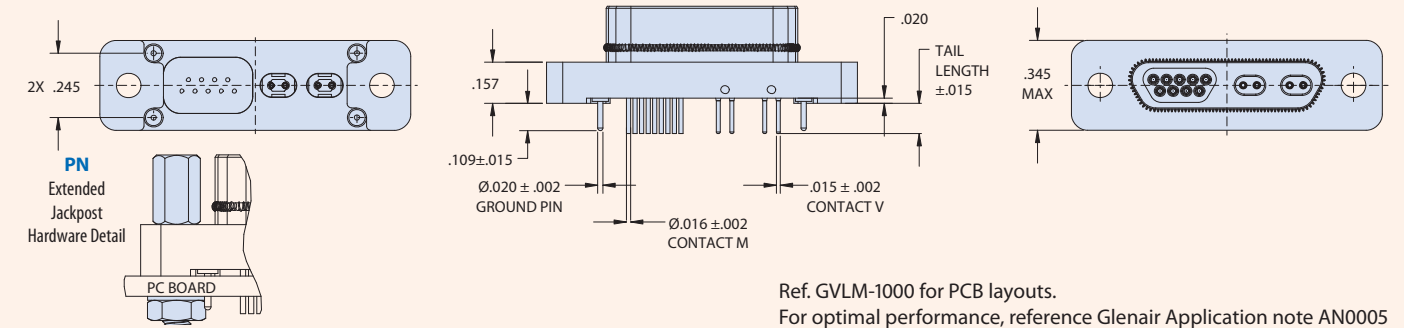

How To Order VersaLink Micro-D Right-Angle Board-Mount Connectors										
Sample Part Number	GVLM	2	L-	2-9	P	BR	P	T	-110	
Series	GVLM = Glenair VersaLink Micro-D									
Shell Finish	2 = Nickel 5 = Gold									
Insulator Material	L = LCP or PPS									
Contact Layout (V-M)	1-0, 2-0, 1-9, 2-9, 4-0, 2-15, 3-9, 4-15, 4-31, 8-9, 10-0									
Contact Type ¹	P = Pin (Plug) S = Socket (Receptacle) [designation is for Micro-D contacts, see note 1 below]									
Termination Type	BR = Board Right Angle									
Hardware ²	P = Jackpost									
Threaded Insert Option	T = Threaded Insert in Board-Mount Hole Omit for Through-Hole									
PC Tail Length ³	.080, .110, .140 (Length in Inches ±.015)									

1 - Plug connector uses Pin Micro-D contacts and Socket VersaLink contacts. Receptacle uses Socket Micro-D contacts and Pin VersaLink contacts
2 - Hardware is always required to ensure connector pair is fully mated when installed
3 - PC Tails solder-dipped in 60/40 Tin-Lead solder

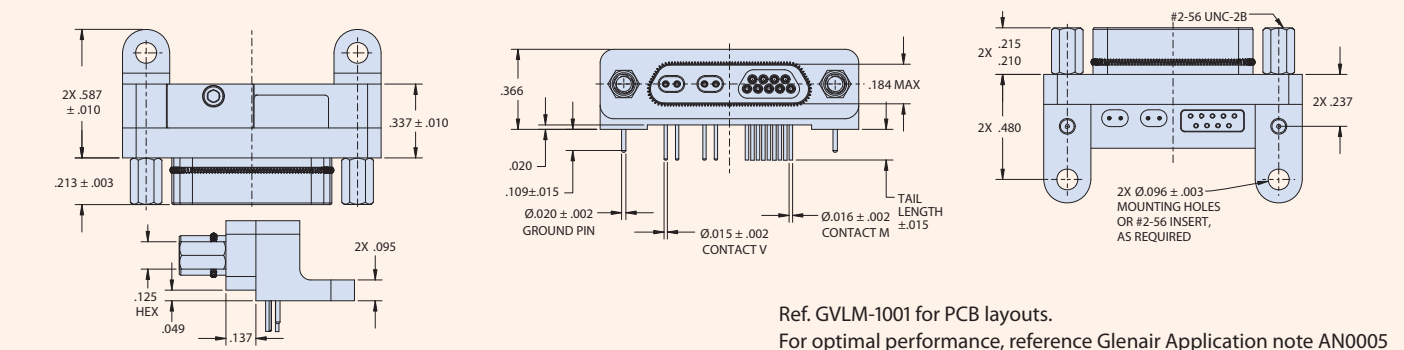



VersaLink Bridge: 100 Ohm connectors and jumpers for high-speed board applications

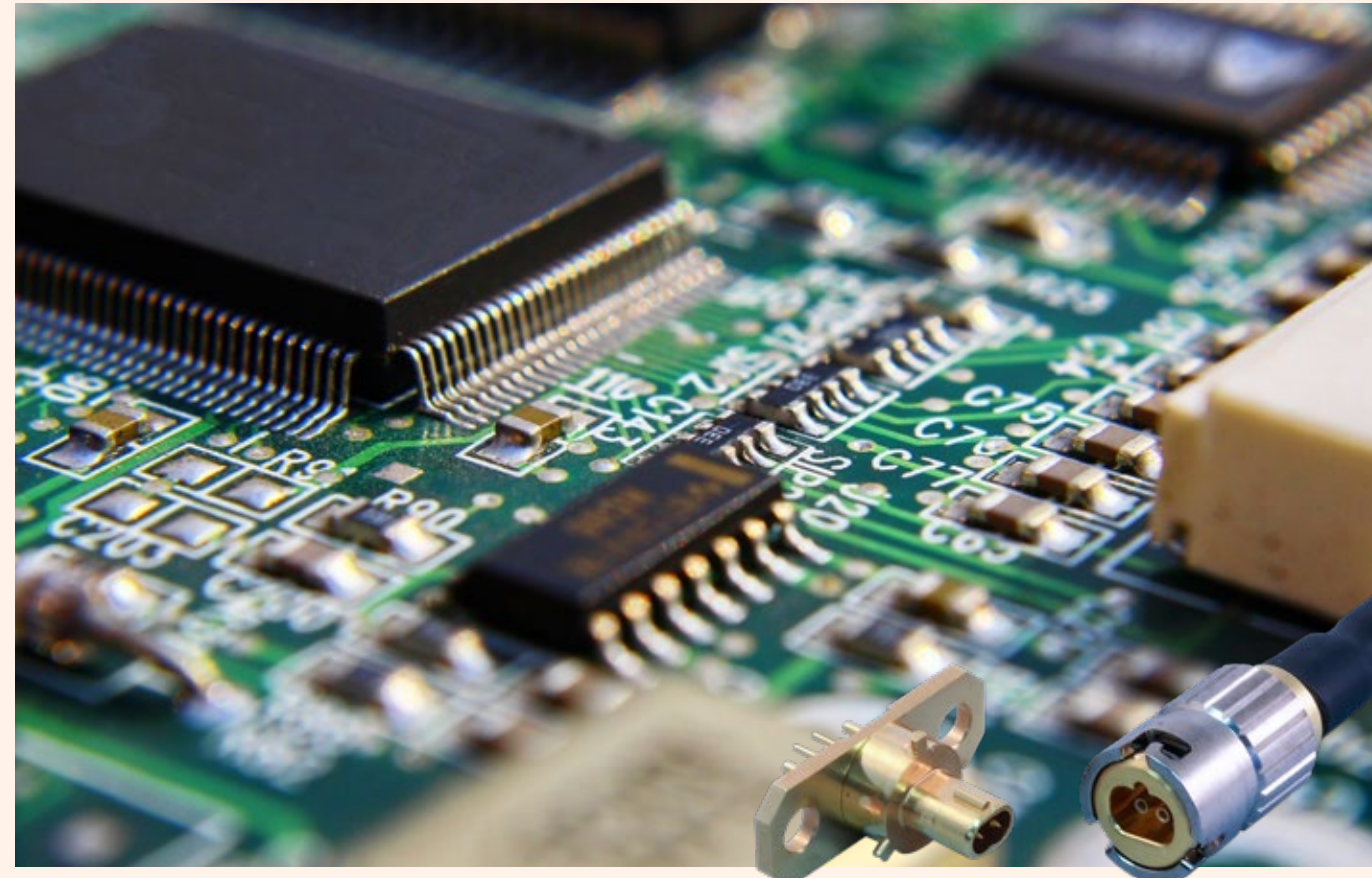

VersaLink Bridge: bypass high-loss board traces with a low insertion-loss and low signal-latency point-to-point Twinax jumper

High-speed data transmission from one PCB to another, from one side of a backplane to another, or even from one side of a complex embedded system to another, is frequently accomplished by routing high-speed traces on a dedicated high-speed signal layer. This is a complex assignment—fraught with potential for impedance discontinuities and unacceptable insertion loss—as traces must navigate difficult and/or long routing paths around via columns and other board irregularities. The Glenair VersaLink Bridge is a high-density, micro-form factor twinax connector / jumper assembly used to bridge the gap between point A and point B on the board (such as between two SML integrated circuit chips) with better signal integrity than native board traces can ever deliver. VersaLink Bridge is equally capable of dramatically reducing insertion loss and signal latencies for data traffic between an ASIC and the I/O.

Right-angle bayonet-lock version for high shock and vibrate applications

VERSALINK BRIDGE FEATURES

- Small footprint, high-density solution
- Versatile solder-mount or screw-mount board termination
- 100 Ohm differential Twinax
- Push-pull mating or bayonet-lock for high vibration and shock applications
- Keyed polarization prevents mis-mating
- Low insertion loss and low signal latencies for high data rate board transmissions



Differential Twinax “bypass” connector and jumper assemblies

AVAILABLE CONFIGURATIONS: QUICK-DISCONNECT

Quick-disconnect plug	QDC Jack board pin straight screw mount	QDC Jack board pin straight solder mount	QDC Jack board pin right-angle screw mount	QDC Jack board pin right-angle solder mount

AVAILABLE CONFIGURATIONS: BAYONET-LOCK

Bayonet-lock plug	Bayonet-lock Jack board pin straight screw mount	Bayonet-lock Jack board pin straight screw mount

Recommended Cable for Plug Connectors

Cable P/N	Cable Construction	Wire Gauge	Impedance	Max. Overall Size
963-043-26	Twinax In-Line	26	100 Ω	.121" X .076"

MATERIALS AND FINISHES

Contacts: Copper alloy / gold
Insulators: Superior rigid dielectric
Body: Copper alloy / gold
Ferrules (plugs): Copper alloy / electroless nickel
Spring (plugs): Music wire

ELECTRICAL PARAMETERS

(for Board Connectors)

Impedance: 100 Ohms
DWV: 500 RMS
IR: 5000 Megaohms min. at 200 VDC

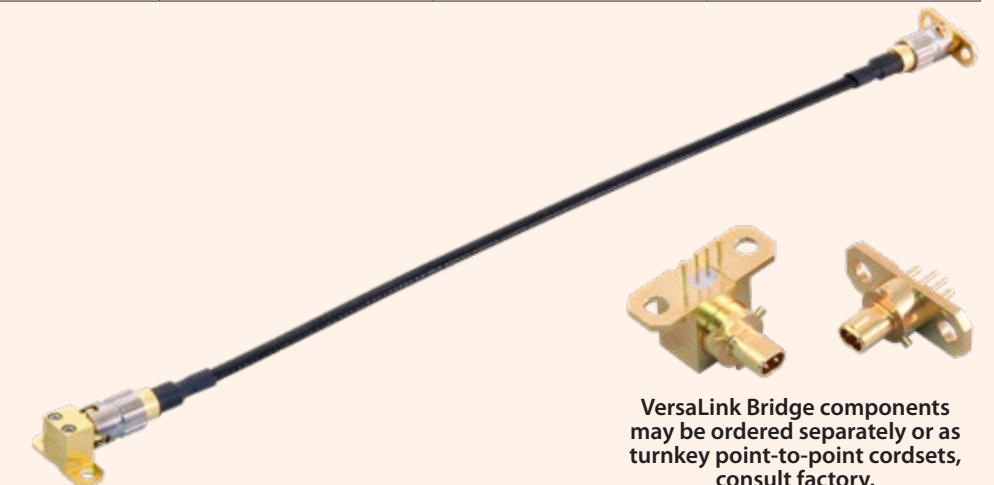

VersaLink Bridge components may be ordered separately or as turnkey point-to-point cordsets, consult factory.

How To Order VersaLink Bridge Quick-Disconnect Plug Connectors

Sample Part Number	853-051
Series	853-051 VersaLink Bridge Plug socket QDC connectors

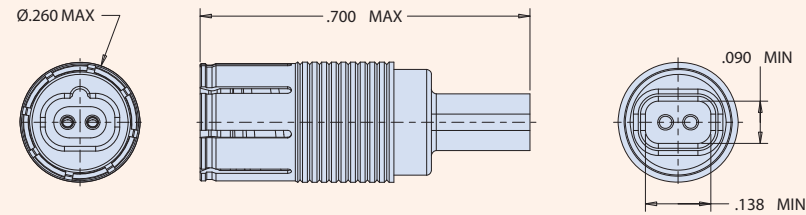

How To Order VersaLink Bridge Quick-Disconnect Straight Board Connectors

Sample Part Number	853-052	-1	G	-.140
Series	853-052 VersaLink Bridge straight board pin QDC connectors			
Mounting Style	1 = Solder Mount 2 = Screw Mount			
PC Tail Finish	S = Solder dipped in 63/37 Tin/Lead G = Gold Plated			
PC Tail Length	-.140, -.110, -.080 (length in inches)			

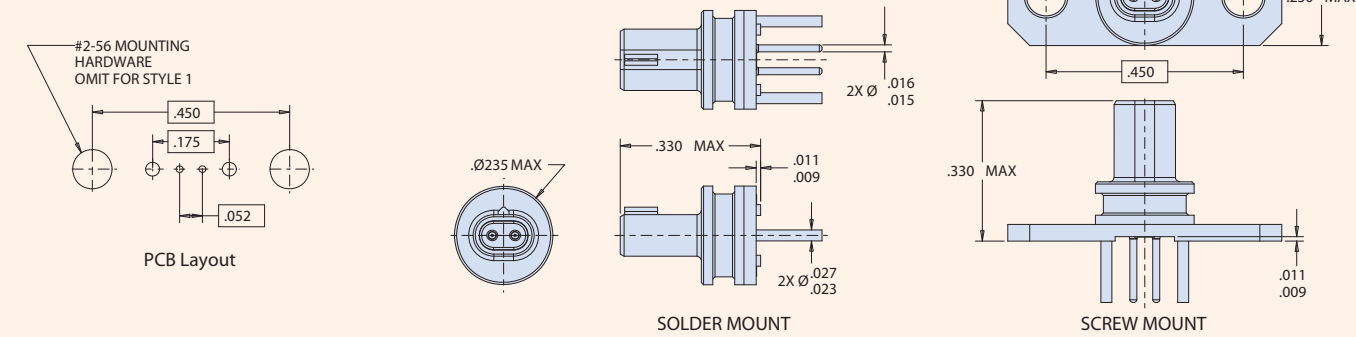

How To Order VersaLink Bridge Quick-Disconnect Right-Angle Board Connectors

Sample Part Number	853-054	-1	G	-.140
Series	853-054 VersaLink Bridge Right-angle board pin QDC connectors			
Mounting Style	1 = Solder Mount 2 = Screw Mount			
PC Tail Finish	S = Solder dipped in 63/37 Tin/Lead G = Gold Plated			
PC Tail Length	-.140, -.110, -.080 (length in inches)			

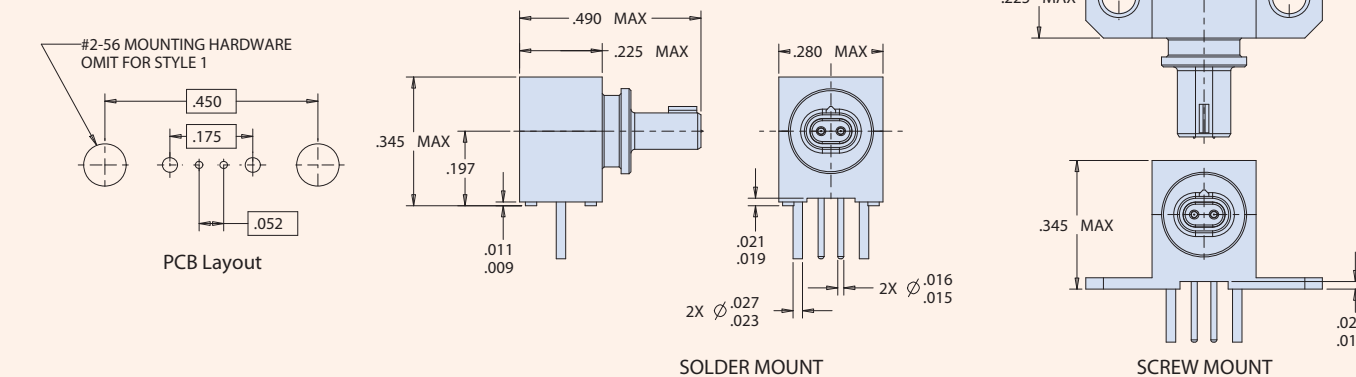

How To Order VersaLink Bridge Bayonet-Lock Plug Connectors

Sample Part Number	853-064
Series	853-064 VersaLink Bridge Plug socket bayonet connectors

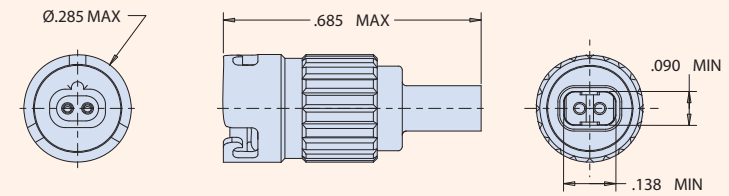

How To Order VersaLink Bridge Bayonet-Lock Straight Board Connectors

Sample Part Number	853-065	G	-.140
Series	853-065 VersaLink Bridge Bayonet-lock straight board pin connector		
PC Tail Finish	S = Solder dipped in 63/37 Tin/Lead G = Gold Plated		
PC Tail Length	-.140, -.110, -.080 (length in inches)		

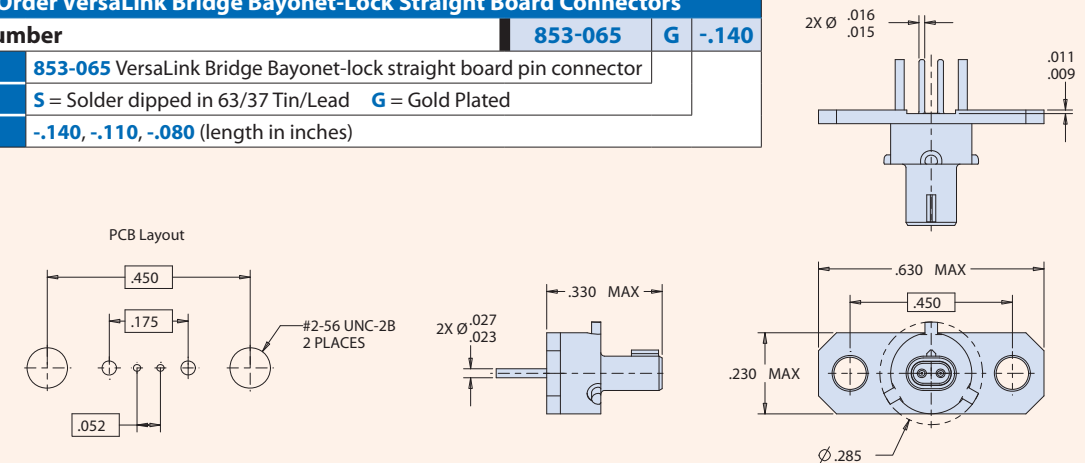

How To Order VersaLink Bridge Bayonet-Lock Right-Angle Board Connectors

Sample Part Number	853-067	G	-.140
Series	853-067 VersaLink Bridge Bayonet-lock right-angle board pin connector		
PC Tail Finish	S = Solder dipped in 63/37 Tin/Lead G = Gold Plated		
PC Tail Length	-.140, -.110, -.080 (length in inches)		

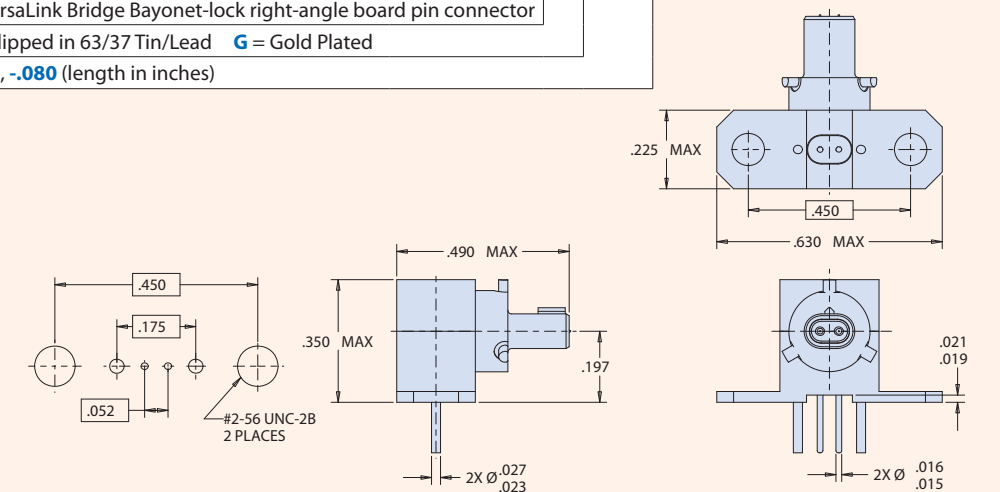



Smallest and lightest
aerospace-grade
high-speed
connector solution



Miniaturized Micro-D Connector / TwistPin contact solution with 10+ Gb/sec. performance per differential pair

High-speed datalink applications such as aircraft avionics and other high data rate and bandwidth equipment require both optimized data transmission performance as well as robust mechanical and EMC performance. Micro-D connector packaging with high-retention-force TwistPin contacts has a proven track record in standard signal and power applications. Now Glenair has developed a Micro-D solution—intermountable in existing Micro-D panel cutouts—that brings high-speed datalink performance to these mission-critical platforms. The High-Speed Micro-D is a 1 Amp pre-wired cable and PCB solution with 10+ Gb/sec. performance per differential pair. Auxiliary EMC ground springs on plug and integral contact separation architecture ensures data integrity and low attenuation performance.

High-Speed Micro-D connectors and cables are optimized for high-speed digital datalink protocols with machined-shell packaging, low attenuation contact spacing, and ultra low PPS dielectric insulators.



- Pre-wired factory cordsets and PCB connectors
- Unique contact isolation and spacing for optimal high-speed performance
- Standard layouts support maximum #28 AWG wire
- Ultra-low dielectric material combined with optimized contact size and spacing
- Precision-machined shells with gold or nickel plating
- Hybrid contact solutions available with 3 amp and 1 amp TwistPin contacts (perfect for USB 3.0 SuperSpeed applications)



The miniature high-speed connector with mil-spec pedigree connector and contact packaging

SUPPORTED HIGH-SPEED PROTOCOLS

Shell Sizes and contact arrangements optimized for today's popular high-speed protocols



21	21	25	21
Display Port 1.2	HDMI 2.0	DVI-D Dual	DVI-D Single
9	15	9	15
eSATA/SATA 3	USB 3.0	USB 2.0	Up To: Cat 6A (10GBASE-T)

Micro-D High-Speed configurations include wired assemblies and straight or 90° PCB-mount connectors. Insert arrangements feature 1 Amp Nanominiature TwistPin contacts. Hybrid 1 Amp/3 Amp arrangements for USB 3.0 SuperSpeed are also available. All designs have been tested for today's popular high-speed protocols.

EMI SHIELDING AND ENVIRONMENTAL SEALING



High-Speed Micro-D contact arrangements face view pin connector

- high-speed signal pair
- signal-pair drain wire
- low-speed signal or power contacts

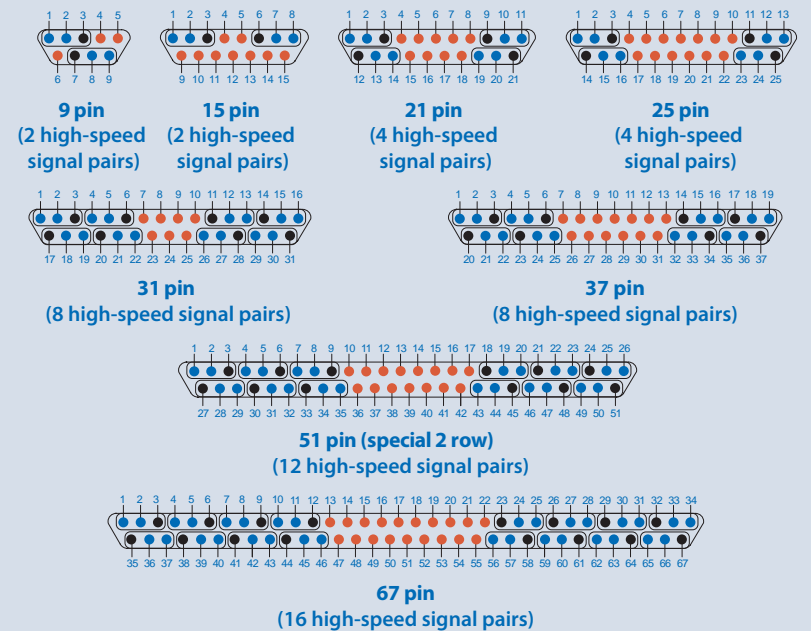

MATERIALS AND FINISHES

Connector Shell: Aluminum Alloy 6061
Insulator: Polyphenylene Sulfide (PPS)
Flange Seal: Fluorosilicone Rubber, Blue
Pin Contact: Copper Alloy, Gold over Nickel Plating
Socket Contact: Copper Alloy, Gold over Nickel Plating
Ground Spring: Stainless Steel, Gold Plating
Hardware: 300 Series Stainless Steel, Passivated
Epoxy Resin Hysol EE4215 and Stycast 2850FT/Catalyst 11

*Contact factory for custom configurations supporting up to 3 Amps.

**Add (10 Ounces) X (# of 3 Amp Contacts) for mating force for configurations with 3 Amp contacts

PERFORMANCE SPECIFICATIONS

Current Rating: 1 Amp*
DWV: 600 VAC Sea Level
Insulation Resistance: 5000 Megohms Minimum (500 VDC)
Contact Resistance: 80 Milliohms Maximum
Operating Temperature: -55°C To 125°C
Mating Force: (7 Ounces) X (# of 1 Amp Contacts)**
Durability: 500 Mating Cycles



How To Order High-Speed Micro-D Wired Connectors												
Sample Part Number	GHSM	2	R	-31	P	-A	8	J	1	-18	L	A
Series	GHSM = Glenair High-Speed Micro-D											
Shell Finish	2 = Nickel 5 = Gold											
Insulator Material	R = PPS											
Contact Layout	9, 15, 21, 25, 31, 37, 51-2, 67											
Contact Type	P = Pin (Single-End Plug) S = Socket (Single-End Receptacle) GP = Double-End Cable, Pin Connectors Both Ends GS = Double-End Cable, Socket Connectors Both Ends CS = Double-End Cable, Pin and Socket											
High Speed Cable Type	A = Glenair Cable 963-128-28 (100 Ohm) B = Glenair Cable 963-130-28 (90 Ohm)											
Discrete Wire Gage (AWG)	8 = #28 0 = #30 (J Wire Type only)											
Discrete Wire Type	K = M22759/11 600 VRMS Teflon (TFE) J = M22759/33 600 VRMS Modified Cross-Linked Tefzel (ETFE)											
Discrete Wire Color	1 = White 7 = Ten Color Repeating											
Wire Length	Wire Length in Inches, 6 Inch Minimum											
Mounting Hardware ¹	L, M, P, S, (See Mounting Hardware Designations table below)											
Shield and Jacket Option	X - ArmorLite Braided Microfilament Stainless Steel shield with E-CTFE Halar "Expando" Jacket W - ArmorLite Braided Microfilament Stainless Steel shield Z - 75% Braided AmberStrand shield with E-CTFE Halar "Expando" Jacket V - 75% Braided AmberStrand shield T - 100% Braided AmberStrand shield with E-CTFE Halar "Expando" Jacket S - 100% Braided AmberStrand shield C - Braided shield (Nickel Over Copper) with E-CTFE Halar "Expando" Jacket A - Braided shield (Nickel over Copper) N - No Shield, No Jacket (customer to install)											

1 - Hardware is always required to ensure connector pair is fully mated when installed

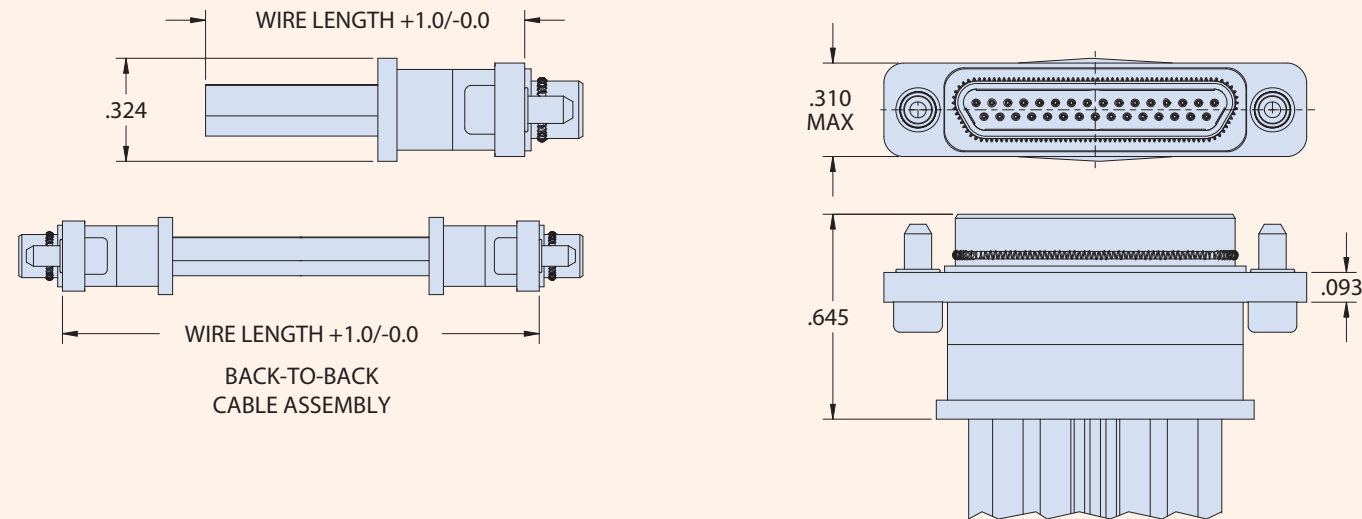

Mounting Hardware Designations			
P Jackpost	M Hex Head Jackscrew	S Slot Head Jackscrew	L Hex Head Jackscrew, Non-Removable



How To Order High-Speed Micro-D Board Straight Surface Mount Connectors										
Sample Part Number	GHSM	2	R	-25	S	BSS	PU			
Series	GHSM = Glenair High-Speed Micro-D									
Shell Finish	2 = Nickel 5 = Gold									
Insulator Material	R = PPS									
Contact Layout	9, 15, 21, 25, 31, 37, 51-2, 67									
Contact Type	P = Pin (Plug) S = Socket (Receptacle)									
Termination Type	BSS = Board Straight Surface Mount									
Jackpost Option (see table below)	PN = Extended Jackpost for .062" PCB RN = Extended Jackpost for .196" PCB PU = Short Jackpost and Threaded Insert Rear Panel Jackpost with Threaded Insert R2U = .032" Panel R3U = .047" Panel R4U = .062" Panel R5U = .094" Panel R6U = .125" Panel R7U = .080" Panel									

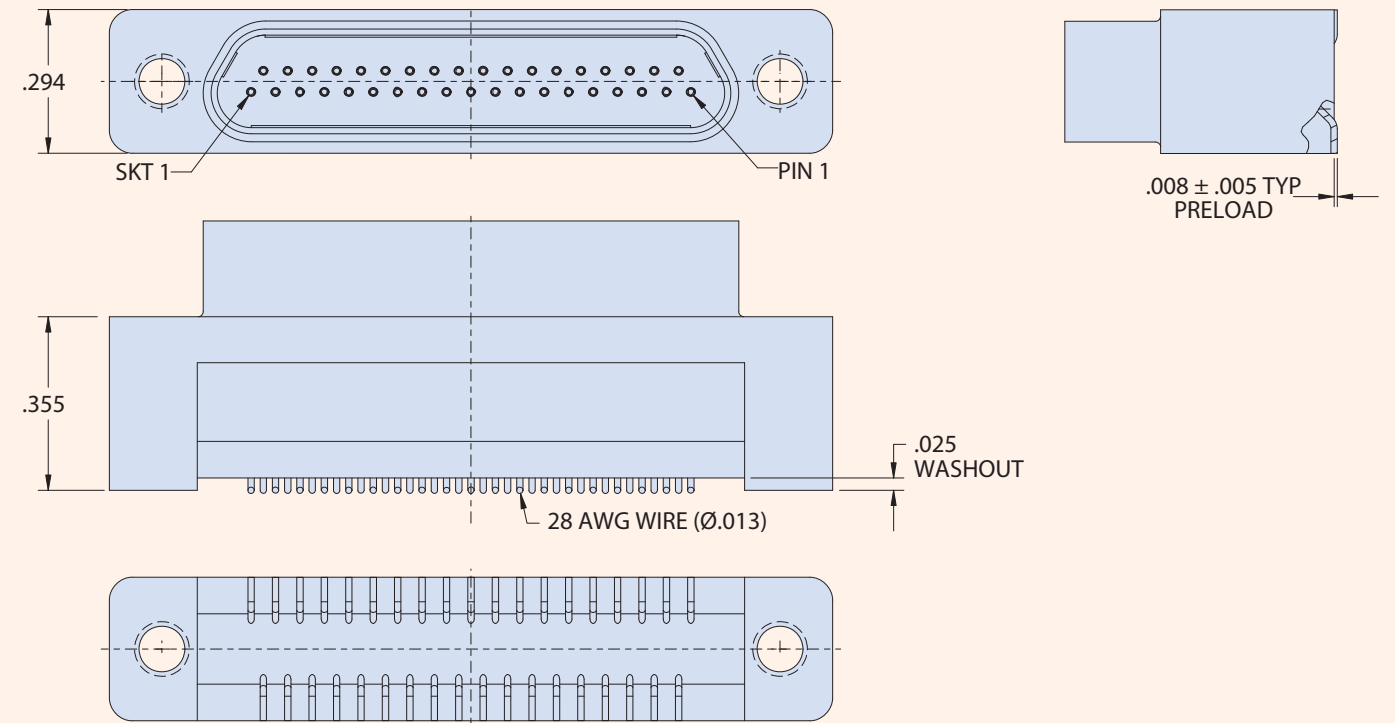

Jackpost Options		
PN/RN Extended Jackpost	PU Short Jackpost with Threaded Insert	RU Rear Panel Jackpost with Threaded Insert



How-to-order
GHSM-HBR Hybrid Board Right-Angle connectors

How To Order High-Speed Micro-D Hybrid Board Right Angle Connectors	
Sample Part Number	GHSM 2 R -25 S HBR P T -.110
Series	GHSM = Glenair High-Speed Micro-D
Shell Finish	2 = Nickel 5 = Gold
Insulator Material	R = PPS
Contact Layout	9, 15, 21, 25, 31, 37, 51-2, 67
Contact Type	P = Pin (Plug) S = Socket (Receptacle)
Termination Type	HBR = Hybrid Board Right Angle
Jackpost Option (see table below)	P = Jackpost L = Hex Head Jackscrew (non-removable) Jackposts for Rear Panel Mounting R1 = .032" Panel R2 = .047" Panel R3 = .062" Panel R4 = .093" Panel R5 = .125" Panel R6 = .080" Panel
Threaded Insert Option	T = Threaded Insert in Board Mounting Hole Omit for Thru-Hole
Right-Angle Lead Length	-.080, -.110, -.140, -.172 (Length in Inches ±.015)

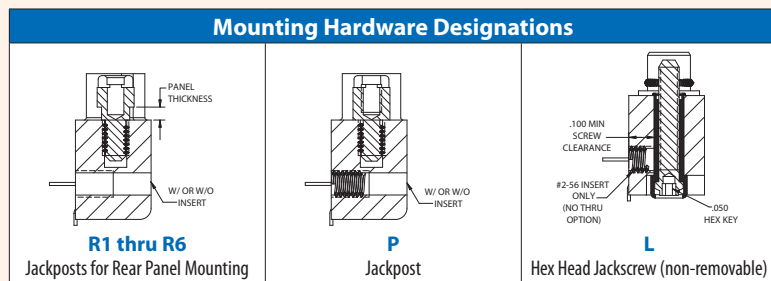
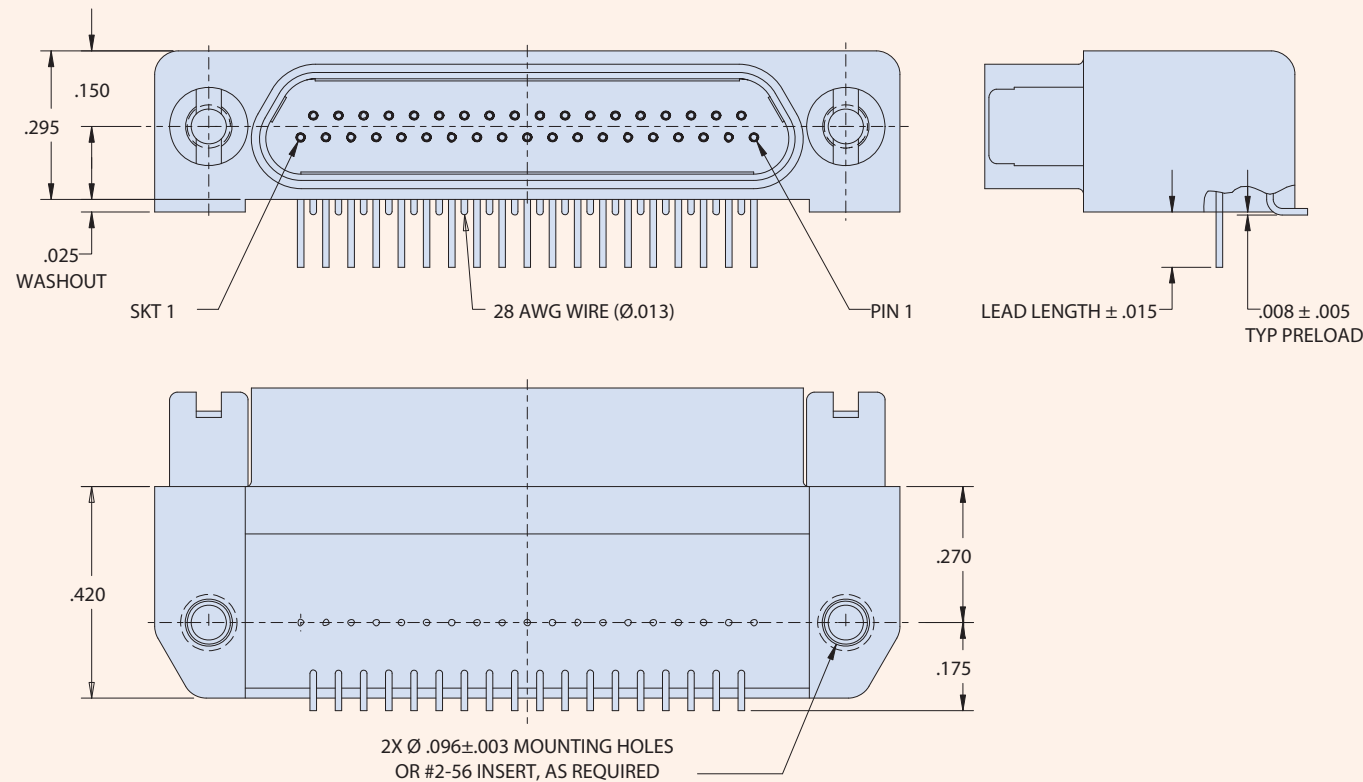

How-to-order
GHSRPM Rear-Panel Mount Cable Assembly Connectors

How To Order High-Speed Micro-D Wired Connectors	
Sample Part Number	GHSRPM 2 R -31 P -A 8 J 1 -18 R3 N
Series	GHSRPM = Glenair High-Speed Micro-D, Rear Panel Mount
Shell Finish	2 = Nickel 5 = Gold
Insulator Material	R = PPS
Contact Layout	9, 15, 21, 25, 31, 37, 51-2, 67
Contact Type	P = Pin (Plug) S = Socket (Receptacle)
High Speed Cable Type	A = Glenair Cable 963-128-28 (100 Ohm) B = Glenair Cable 963-130-28 (90 Ohm)
Discrete Wire Gage (AWG)	8 = #28 0 = #30 (J Wire Type only)
Discrete Wire Type	K = M22759/11 600 VRMS Teflon (TFE) J = M22759/33 600 VRMS Modified Cross-Linked Tefzel (ETFE)
Discrete Wire Color	1 = White 7 = Ten Color Repeating
Wire Length	Wire Length in Inches, 6 Inch Minimum
Mounting Hardware	R1 = .032" Panel R2 = .047" Panel R3 = .062" Panel R4 = .093" Panel R5 = .125" Panel R6 = .080" Panel
O-Ring Material	C = Conductive N = Non-Conductive (Nitrile)

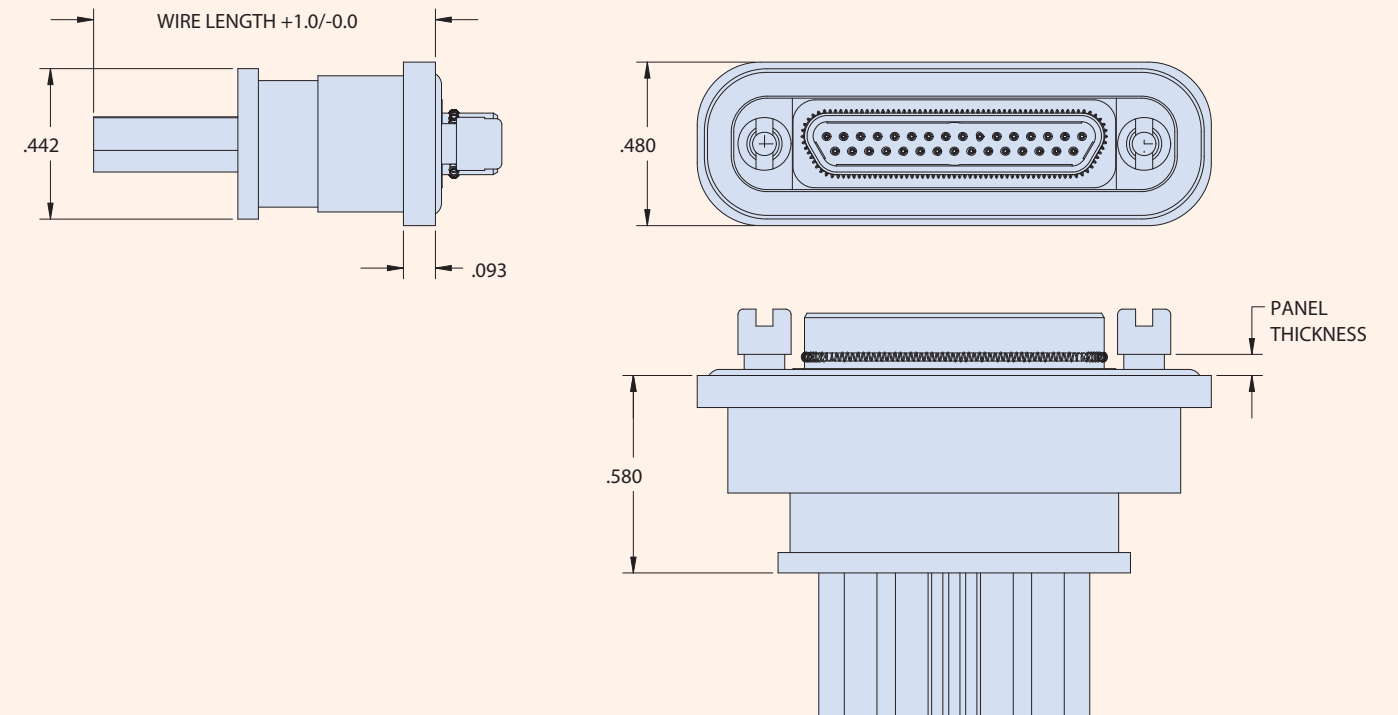



How-to-order
GHSRPM-BSS Rear-Panel Board Straight Surface Mount connectors

How To Order High-Speed Micro-D Board Straight Surface Mount Connectors								
Sample Part Number	GHSRPM	2	R	-25	P	BSS	R3	N
Series	GHSRPM = Glenair High-Speed Micro-D, Rear Panel Mount							
Shell Finish	2 = Nickel 5 = Gold							
Insulator Material	R = PPS							
Contact Layout	9, 15, 21, 25, 31, 37, 51-2, 67							
Contact Type	P = Pin (Plug) S = Socket (Receptacle)							
Termination Type	BSS = Board Straight Surface Mount							
Rear Panel Mount Hardware Option	R2U = .032" Panel R3U = .047" Panel R4U = .062" Panel R5U = .094" Panel R6U = .125" Panel R7U = .080" Panel							
O-Ring Material	C = Conductive N = Non-Conductive (Nitrile)							

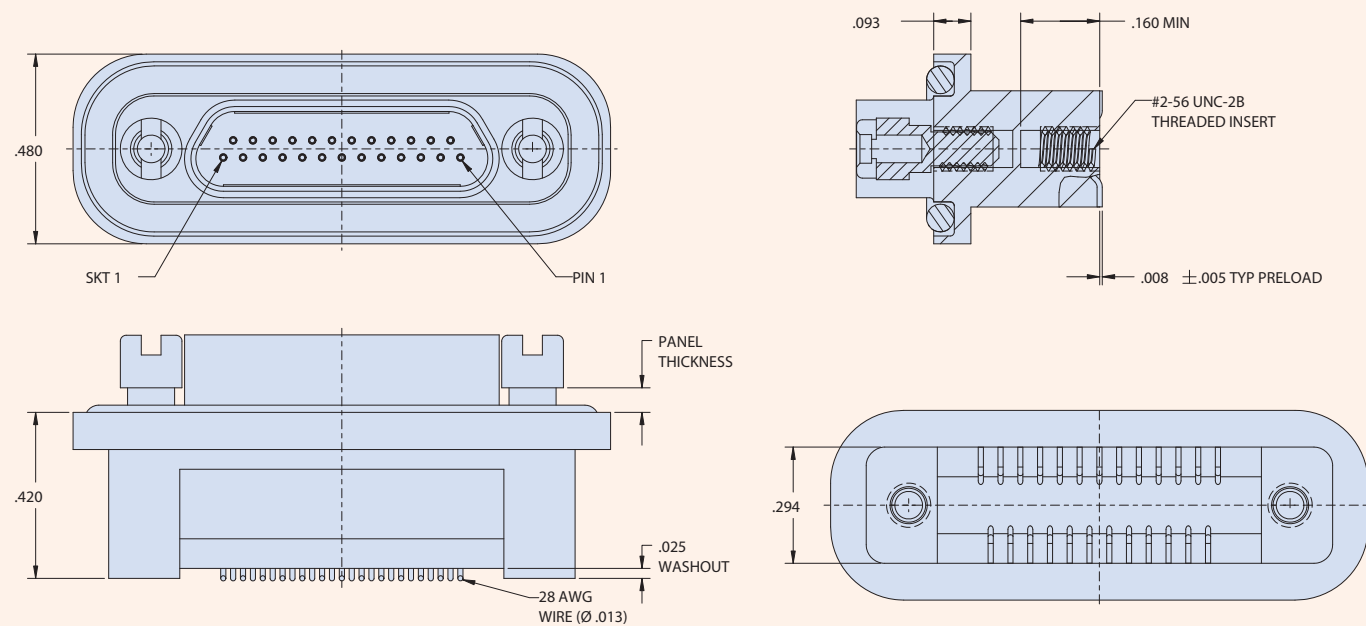

How-to-order
GHSRPM-HBR Rear-Panel Hybrid Board Right-Angle Connectors

How To Order High-Speed Micro-D Hybrid Board Right Angle Connectors											
Sample Part Number	GHSRPM	2	R	-25	P	HBR	R3	T	N	-.110	
Series	GHSRPM = Glenair High-Speed Rear-Panel Micro-D										
Shell Finish	2 = Nickel 5 = Gold										
Insulator Material	R = PPS										
Contact Layout	9, 15, 21, 25, 31, 37, 51-2, 67										
Contact Type	P = Pin (Plug) S = Socket (Receptacle)										
Termination Type	HBR = Hybrid Board Right Angle										
Rear Panel Mount Hardware Option	R1 = .032" Panel R2 = .047" Panel R3 = .062" Panel R4 = .093" Panel R5 = .125" Panel R6 = .080" Panel										
Threaded Insert Option	T = Threaded Insert in Board Mounting Hole Omit for Thru-Hole										
O-Ring Material	C = Conductive N = Non-Conductive (Nitrile)										
Right-Angle Lead Length	-.080, -.110, -.140, -.172 (Length in Inches ±.015)										

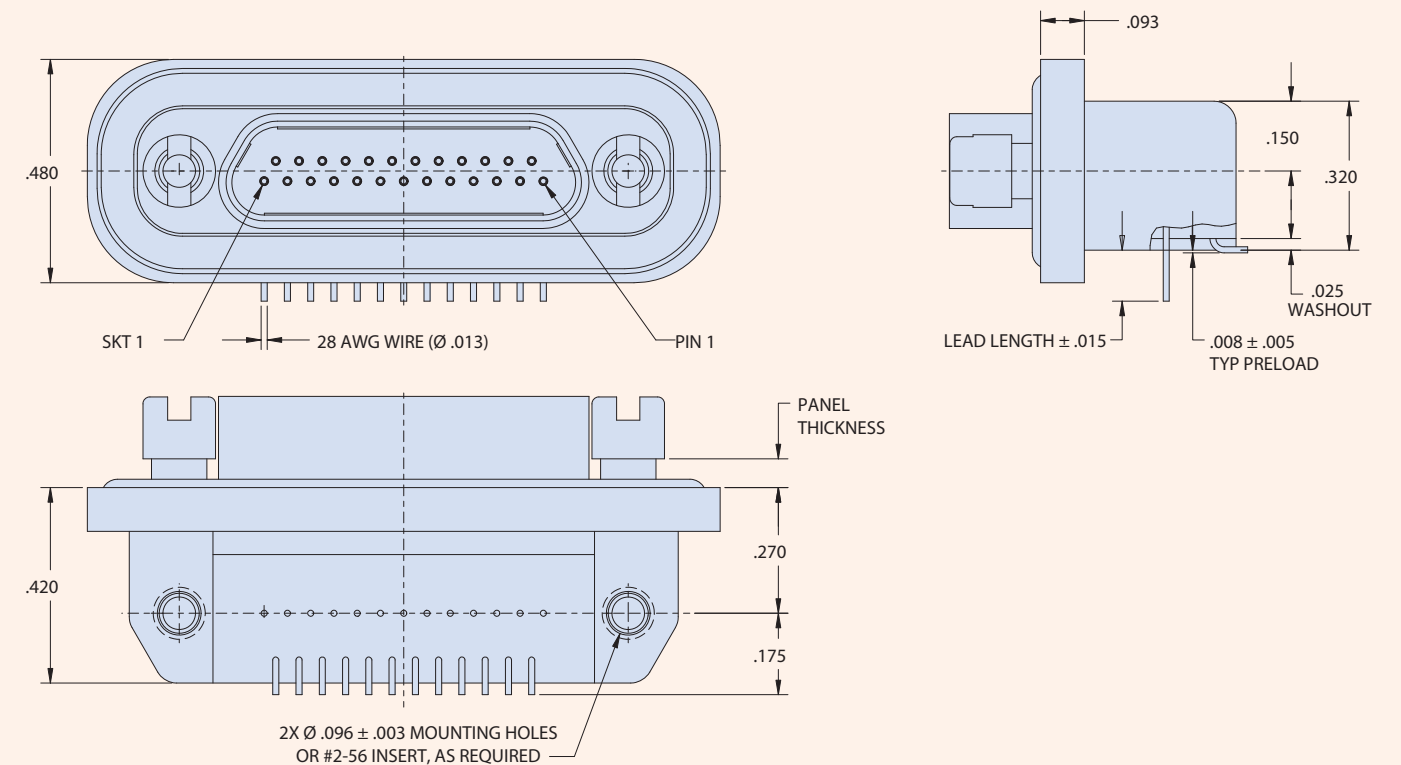

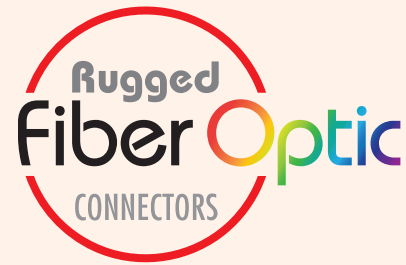

SuperNine®
Tight-Tolerance
MIL-DTL-38999 Sr. III
Fiber Optic Connection
System



The high-performance fiber optic interconnect system successfully deployed in hundreds of commercial and military aerospace and other applications—from F-16 upgrade systems to the revolutionary F-35 Joint Strike Fighter



Terminated and tested point-to-point and multibranch D38999 type fiber optic cable assemblies

- Composite, aluminum and stainless steel shells available
- Qualified size #16 MIL-PRF-29504 precision ceramic termini
- Singlemode and multimode fiber, from 9/125 to 1000 microns
- Ultra-low insertion loss values, <.50dB typical
- From 2 to 37 Termini
- Plug and In-Line, Jam Nut and Square Flange Receptacles
- Patented MIL-DTL-38999 fiber optic test probes and adapters

SuperNine®
MIL-DTL-38999 Series III Type
Advanced fiber optic connection system



MIL-DTL-38999 type fiber optic connection system termination, inspection, test, and cleaning tools are available now from Glenair. We also offer comprehensive F/O training services for assembly and maintenance technicians.

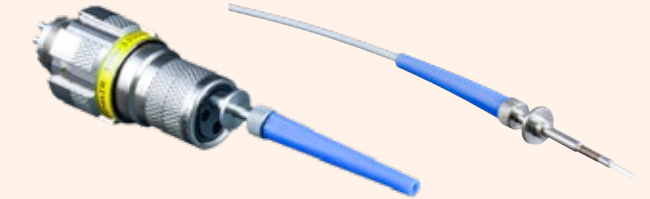

Glenair optical fiber test probes and connector adapters provide accurate and repeatable testing of MIL-DTL-38999 F/O assemblies

Glenair M29504/4 and /5 QPL termini are in stock and ready for immediate, same-day shipment

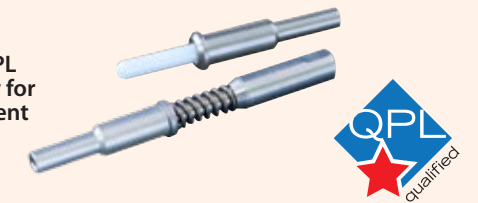

A complete range of metal and composite backshells and protective covers is available

MIL-PRF-29504/04 and /05 Fiber Optic Termini Performance Data	
Test Type	Performance Requirement
Operating Temperature	-55°C to +165°C (dependent on epoxy and cable)
Temperature Cycling	-65°C to +175°C
Thermal Shock	-55°C to +150°C, 5 cycles
Temperature Life	+150°C for 1,000 hours
Random Vibration	20-2,000 Hz, 42.2 g's
Shock (Half-sine Pulse)	300 g Peak Load
Mechanical Shock	MIL-S-901, Grade A, Type B, Class I
Mating Durability	500 cycles (cleaning after 100 matings)
Salt Spray	48 hours (Terminus only)
Cable Retention Force	22.0 lbs (dependent on cable construction)

Select SuperNine Fiber Optic Connector Part Numbers	
Glenair Dwg. Number*	Product Description
181-001	#16 Socket Terminus
181-002	#16 Pin Terminus
181-048	#16 Dummy Terminus
180-091 (05)	In-Line Receptacle Connector
180-091 (06)	Plug Connector
180-091 (08)	Jam Nut Mount Receptacle Connector
180-091 (H7)	Square Flange Wall Mount Receptacle with Round Holes
180-091 (S7)	Square Flange Wall Mount Receptacle with Slotted Holes
180-091 (T7)	Square Flange Wall Mount Receptacle with Tapped Holes

* See fiber optic catalog for complete part number information

INSERT ARRANGEMENTS

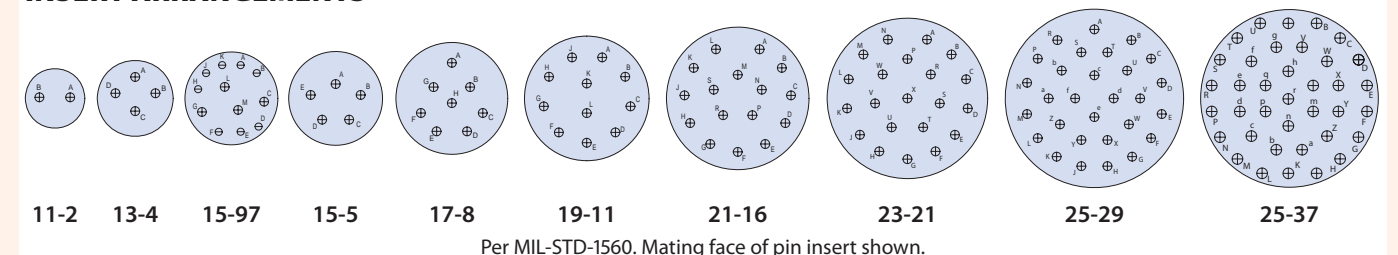

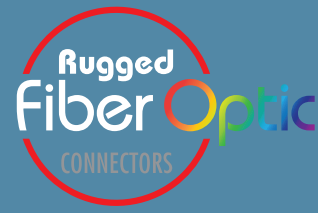

M29504/04 TYPE, STYLE 1 PIN AND SOCKET TERMINI FOR MIL-DTL-38999 SERIES III

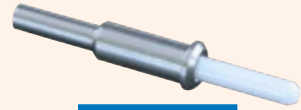

181-002-XXX

Pin Terminus



181-001-XXX

Socket Terminus



181-048-16

Size 16 Dummy Terminus reduces weight and eliminates cost of using expensive contacts

Part Number	Fiber Size Core/Cladding/Coating (Microns)	Ø A (Microns)	Ref. M29504/04-XXXX
181-00X-125	9/125 (Singlemode)	125.5	M29504/04-4208
181-00X-126S	9/125 (Singlemode)	126.0	M29504/04-4209
181-00X-126	50/125 & 62.5/125	126.0	M29504/04-4210
181-00X-127	50/125 & 62.5/125	127.0	M29504/04-4040
181-00X-142	100/140	142.0	M29504/04-4043
181-00X-144	100/140	144.0	N/A
181-00X-145	100/140	145.0	M29504/04-4044
181-00X-156	62.5/125/155 (Polyimide)	156.0	M29504/04-4211
181-00X-157	62.5/125/155 (Polyimide)	157.0	M29504/04-4212
181-00X-173	100/140/172 (Polyimide)	173.0	M29504/04-4087
181-00X-175	100/140/172 (Polyimide)	175.0	M29504/04-4213
181-00X-231	200/230	231.0	N/A
181-00X-236	200/230	236.0	N/A
181-00X-286	200/280	286.0	N/A
181-00X-448	400/440	448.0	N/A
181-00X-533	486/500	533.0	N/A

SUPERNINE FIBER OPTIC CONNECTORS



Part Number Development						
Sample Part Number	180-091	XW	06	-17-8	P	N
Series / Basic Part No.	D38999 Series III Type					
Material/Finish	See Material/Finish Table					
Connector Style	06 = Plug Connector					
Shell Size/Insert Arr.*	IAW MIL-DTL-38999 Series III, Per MIL-STD-1560					
Insert Designation	P = Pin S = Socket					
Alternate Key Position*	A, B, C, D, E, N = Normal; Per MIL-DTL-38999					



Part Number Development						
Sample Part Number	180-091	XW	05	-17-8	P	N
Series / Basic Part No.	D38999 Series III Type					
Finish	See Material/Finish Table					
Connector Style*	05 = In-Line Receptacle					
Shell Size/Insert Arr.*	IAW MIL-DTL-38999 Series III, Per MIL-STD-1560					
Insert Designation	P = Pin S = Socket					
Alternate Key Position*	A, B, C, D, E, N = Normal; Per MIL-DTL-38999					

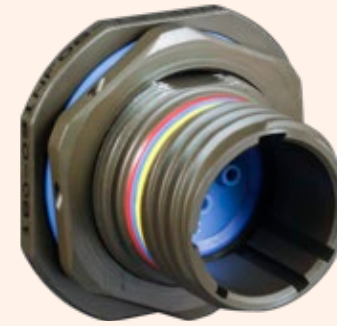

Part number development						
Sample Part Number	180-091	XW	08	-17-8	P	N
Series / Basic Part No.	D38999 Series III Type					
Material/Finish	See Material/Finish Table					
Connector Style	08 = Jam Nut Receptacle					
Shell Size/Insert Arr.*	IAW MIL-DTL-38999 Series III, Per MIL-STD-1560					
Insert Designation	P = Pin S = Socket					
Alternate Key Position*	A, B, C, D, E, N = Normal; Per MIL-DTL-38999					



Part number development						
Sample Part Number	180-091	XW	H7	-17-8	P	N
Series / Basic Part No.	D38999 Series III Type					
Material/Finish	See Material/Finish Table					
Connector Style	H7 = Wall Mount Receptacle with Round Holes (Std)					
Shell Size/Insert Arr.*	IAW MIL-DTL-38999 Series III, Per MIL-STD-1560					
Insert Designation	P = Pin S = Socket					
Alternate Key Position*	A, B, C, D, E, N = Normal; Per MIL-DTL-38999					



Part number development						
Sample Part Number	180-091	XW	S7	-17-8	P	N
Series / Basic Part No.	D38999 Series III Type					
Material/Finish	See Material/Finish Table					
Connector Style	S7 = Wall Mount Receptacle with Slotted Holes					
Shell Size/Insert Arr.*	IAW MIL-DTL-38999 Series III, Per MIL-STD-1560					
Insert Designation	P = Pin S = Socket					
Alternate Key Position*	A, B, C, D, E, N = Normal; Per MIL-DTL-38999					



Part number development						
Sample Part Number	180-091	XW	T7	-17-8	P	N
Series / Basic Part No.	D38999 Series III Type					
Material/Finish	See Material/Finish Table					
Connector Style	T7 = Wall Mount Receptacle with Threaded Insert Holes					
Shell Size/Insert Arr.*	IAW MIL-DTL-38999 Series III, Per MIL-STD-1560					
Insert Designation	P = Pin S = Socket					
Alternate Key Position*	A, B, C, D, E, N = Normal; Per MIL-DTL-38999					

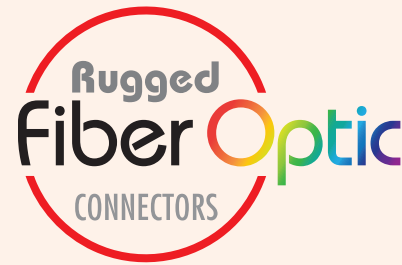

Glenair High Density (GHD): nearly double the density of standard mil-spec fiber optic designs

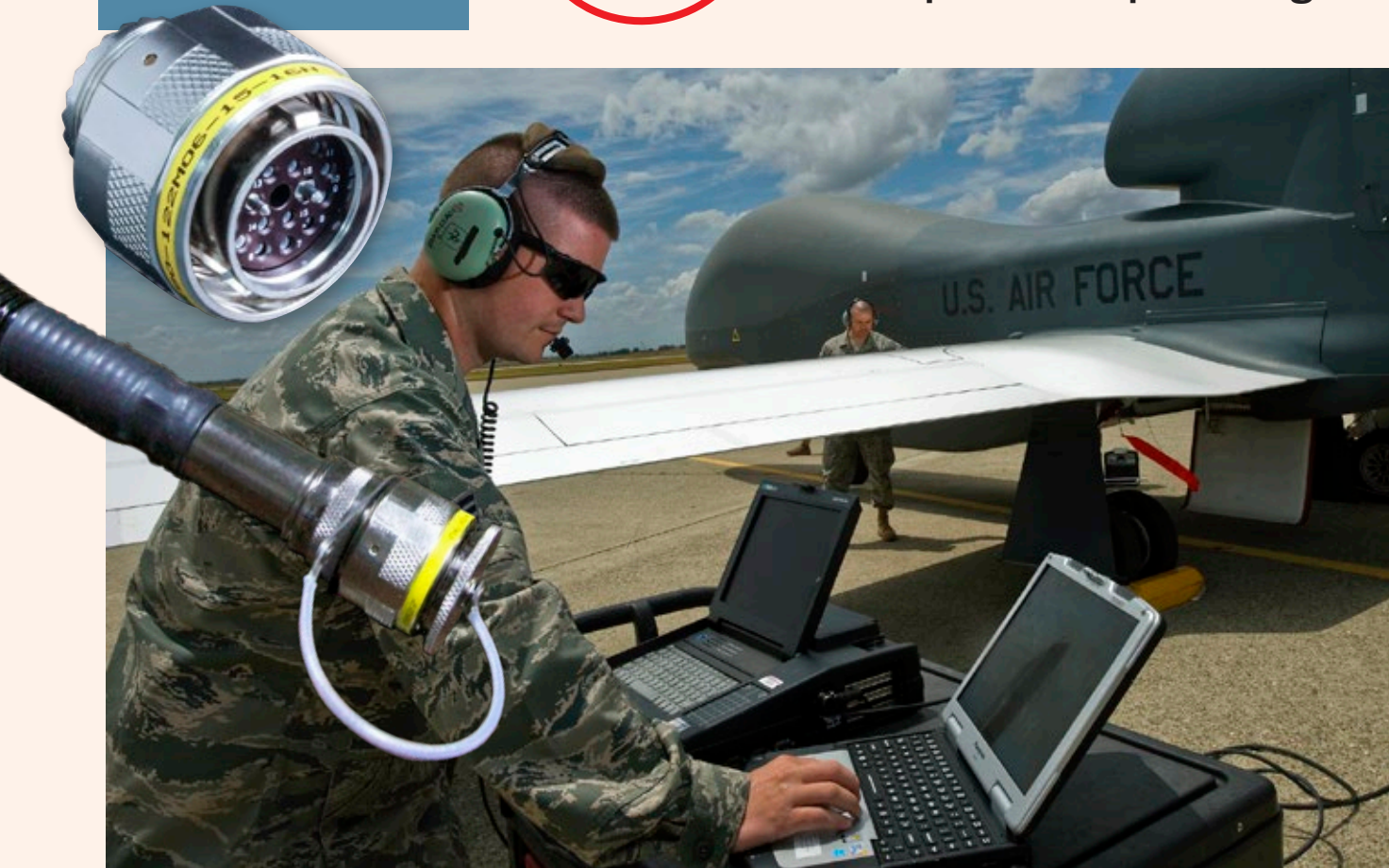

The system of choice for military and commercial air, space and other applications: Outstanding optical and environmental performance with nearly double the density of standard mil-spec solutions



GHD plug connector with alignment sleeve retainer, and square flange receptacle. Termini available in keyed and non-keyed styles

- Innovative #18 (1.25mm ferrule) front-release genderless termini accommodate 900 μ to 2.0mm jacketed fiber
- M85045/16 cable accommodation
- Composite, aluminum or stainless steel shells
- Single keying for APC polish available
- Better optical performance than D38999 with nearly double the density
- Precision alignment sleeve retainer with integrated guide pins
- Piston o-ring sealing—submersible design

SIZE- AND WEIGHT- SAVING Glenair High Density (GHD)

Signature HD fiber optic connection system

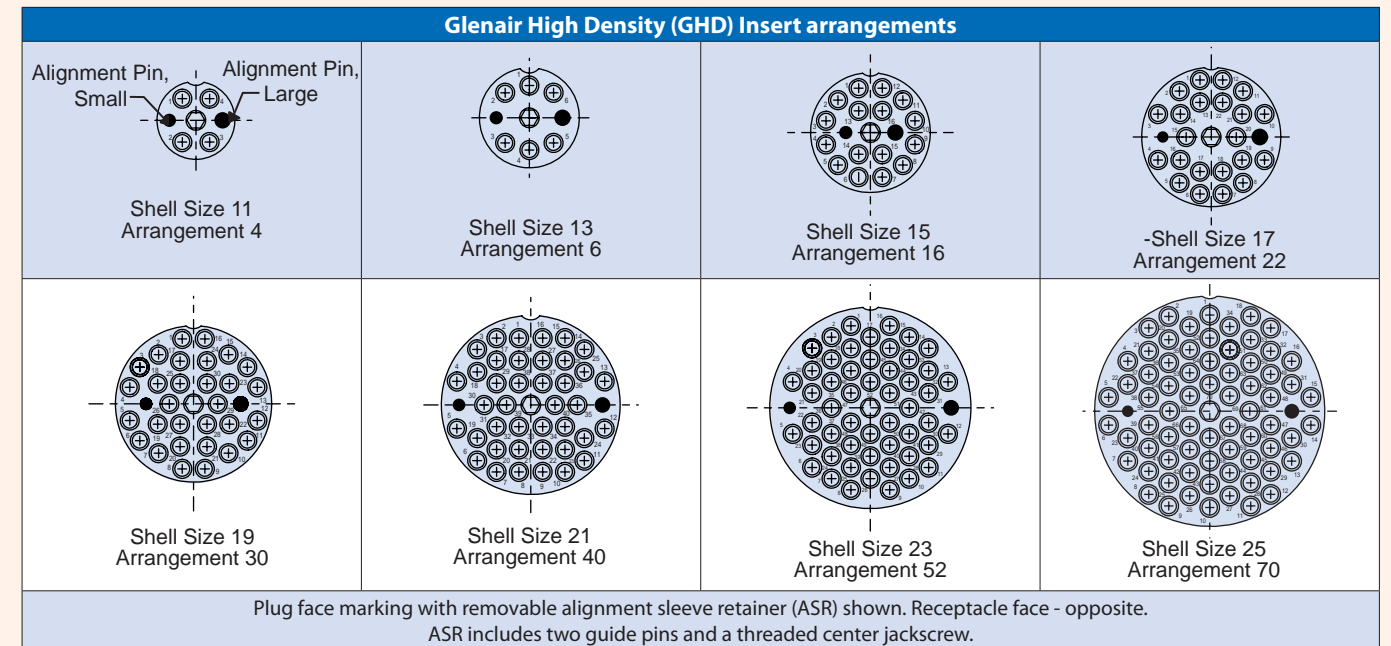

Fiber Optic Pin Termini Specifications			
Assembly Dash Number		Fiber Size	A Dia.
Keyed	Non-Keyed	Core/Cladding	[microns]
181-047-1255C	181-056-1255C	9/125 (Singlemode)	125.5
181-047-1260C	181-056-1260C	9/125, 50/125, 62.5/125	126.0
181-047-1270C	181-056-1270C	50/125, 62.5/125	127.0
181-047-1420C	181-056-1420C	100/140	142.0
181-047-1450C	181-056-1450C	100/140	145.0
181-047-1560C	181-056-1560C	62.5/125/155 (Polyimide)	156.0
181-047-1570C	181-056-1570C	62.5/125/155 (Polyimide)	157.0
181-047-1730C	181-056-1730C	100/140/172 (Polyimide)	173.0
181-047-1750C	181-056-1750C	100/140/172 (Polyimide)	175.0
181-047-2360C	181-056-2360C	200/233	236.0
181-047-2860C	181-056-2860C	200/280	286.0

Crimp Sleeve is supplied with Terminus Assembly, and may be ordered separately. For terminus less crimp sleeve, omit C from end of part number (e.g. 181-056-1260)

GHD Fiber Optic Part Number Reference	
Glenair Dwg. Number	Product Description
181-047	#18 Pin Terminus, Keyed for APC Polish
181-056	#18 Pin Terminus (non-keyed)
181-058	#18 Dummy Terminus
180-122 (05)	In-Line Receptacle Connector
180-122 (06)	Plug Connector with Alignment Sleeve Retainer
180-122 (08)	Jam Nut Mount Receptacle Connector
180-122 (H7)	Square Flange Receptacle with Round Holes
180-122 (S7)	Square Flange Receptacle with Slotted Holes

* See fiber optic catalog for complete part number information

Pin Density Comparison: Glenair High Density Versus D38999 and M28876								
Connector Style / Size	11	13	15	17	19	21	23	25
D38999 Cavity Count	2	4	5	8	11	16	21	29/37
M28876 Cavity Count	2	4	8	N/A	N/A	N/A	31	N/A
GHD Cavity Count	4	6	16	20	30	40	52	70

Glenair High Density (GHD) Features

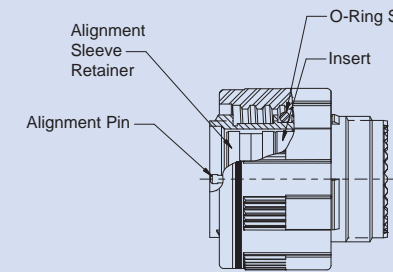

D38999 Series III Style Coupling
Five Alternate Key Positions: A, B, C, D, E (N = Normal)



SIZE- AND WEIGHT- SAVING Glenair High Density (GHD)

Signature HD fiber optic connection system
How to order connectors

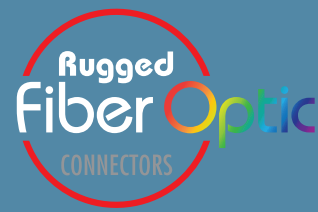

SIZE- AND WEIGHT- SAVING Glenair High Density (GHD)

Signature HD fiber optic connection system
How to order connectors



Part Number Development	
Sample Part Number	180-122 NF 06 -15-16 N C
Series / Basic Part No.	Glenair High Density Fiber Optic Connector
Material/Finish	See Material/Finish Table
Connector Style	06 = Plug with Alignment Sleeve Retainer
Shell Size/Insert Arr.	11-4, 13-6, 15-16, 17-22, 19-30, 21-40, 23-52, 25-70
Alternate Key Position*	A, B, C, D, E, N = Normal
O-Ring Option	C = Conductive O-Ring Omit = Standard O-Ring

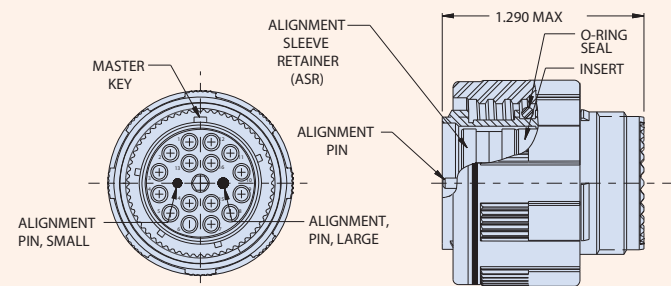

Part Number Development	
Sample Part Number	180-122 ASR -15-16
Series / Basic Part No.	Glenair High Density Fiber Optic Connector
Connector Style	ASR = Alignment Sleeve Retainer
Shell Size/Insert Arr.	11-4, 13-6, 15-16, 17-22, 19-30, 21-40, 23-52, 25-70

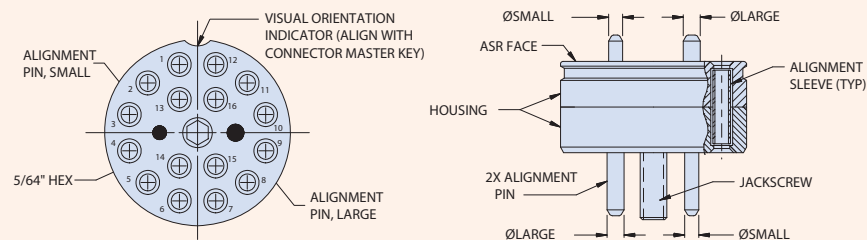

Part Number Development	
Sample Part Number	180-122 NF 08 -15-16 N
Series / Basic Part No.	Glenair High Density Fiber Optic Connector
Material/Finish	See Material/Finish Table
Connector Style	08 = Jam Nut Receptacle
Shell Size/Insert Arr.	11-4, 13-6, 15-16, 17-22, 19-30, 21-40, 23-52, 25-70
Alternate Key Position*	A, B, C, D, E, N = Normal

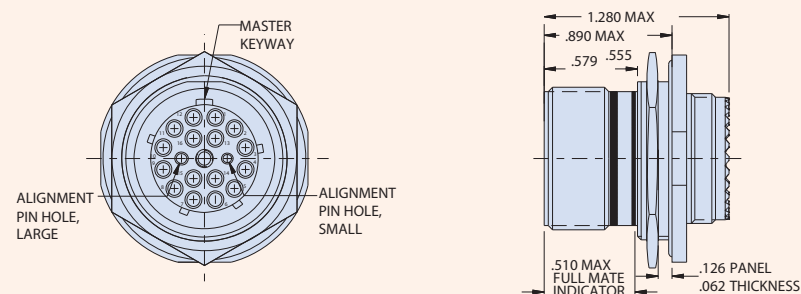

Part Number Development	
Sample Part Number	180-122 NF 05 -15-16 N
Series / Basic Part No.	Glenair High Density Fiber Optic Connector
Material/Finish	See Material/Finish Table
Connector Style	05 = In-Line Receptacle
Shell Size/Insert Arr.	11-4, 13-6, 15-16, 17-22, 19-30, 21-40, 23-52, 25-70
Alternate Key Position*	A, B, C, D, E, N = Normal

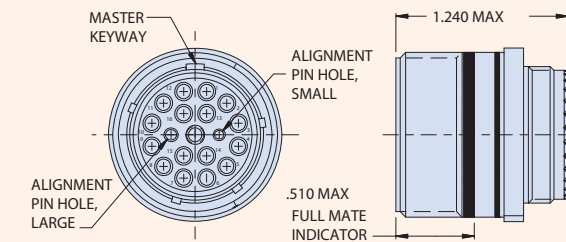

Part Number Development	
Sample Part Number	180-122 NF H7 -15-16 N
Series / Basic Part No.	Glenair High Density Fiber Optic Connector
Material/Finish	See Material/Finish Table
Connector Style	H7 = Wall Mount Receptacle with Round Holes
Shell Size/Insert Arr.	11-4, 13-6, 15-16, 17-22, 19-30, 21-40, 23-52, 25-70
Alternate Key Position*	A, B, C, D, E, N = Normal

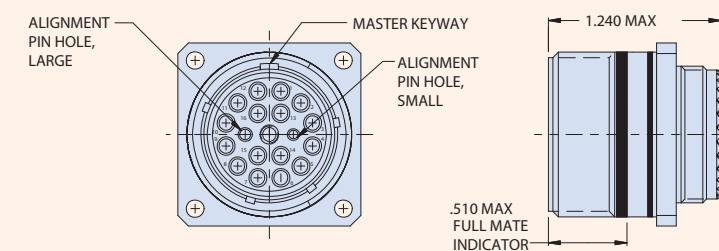

Part Number Development	
Sample Part Number	180-122 NF S7 -15-16 N
Series / Basic Part No.	Glenair High Density Fiber Optic Connector
Material/Finish	See Material/Finish Table
Connector Style	S7 = Wall Mount Receptacle with Slotted Holes
Shell Size/Insert Arr.	11-4, 13-6, 15-16, 17-22, 19-30, 21-40, 23-52, 25-70
Alternate Key Position*	A, B, C, D, E, N = Normal

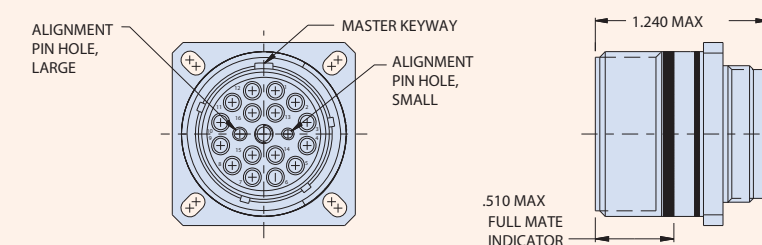

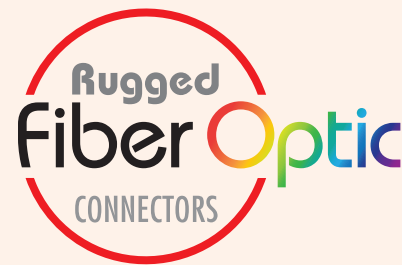

GFR: Glenair Front Release Fiber Optic Connection System



The unique design of the Glenair Front Release system allows for rapid integration of optical media in a broad range of cylindrical and rectangular connector packages. By placing retention and environmental sealing components directly on the termini, Glenair is able to fabricate unique fiber optic connector shell packages without costly tooling and engineering.

- Precision size 16 pin-socket front release termini with integrated retention clip
- Singlemode and multimode for all popular fiber sizes
- Typical insertion loss less than 0.5 dB
- Cylindrical and rectangular connectors
- Connector shells available in aluminum and stainless steel

RAPID INTEGRATION
Glenair Front Release (GFR)

Signature fiber optic connection system



Glenair Front Release (GFR) fiber optic connection systems perform at insertion loss levels equivalent to other high-performance, tactical fiber optic systems such as M29504 termini used in D38999 and M28876 connectors. The GFR system enables Glenair to integrate optical media in Micro-D and D-Subminiature shells as well as micro miniature circular packaging. Contact the factory for availability and application engineering assistance for both standard and custom fiber optic connection systems.

HOW TO ORDER GLENAIR FRONT RELEASE MICRO MINIATURE CIRCULAR CONNECTORS



Contact the Factory for circular connectors requiring enhanced vibration and mechanical shock performance

How To Order GFR Micro Miniature Circular Connectors					
Sample Part Number	180-132	M	06-	9-4	P A
Series	180-132 GFR Micro Miniature Circular				
Shell Size	C	Aluminum Alloy	Anodize, Black		
	M		Electroless Nickel		
	NF		CAD/Olive Drab over Electroless Nickel		
	ZN		Zinc-Nickel/Olive Drab over Electroless Nickel		
	ZNU		Black Zinc-Nickel over Electroless Nickel		
ZI	Stainless Steel	Passivate			
Connector Style	04- Jam Nut w/ Wire Holes		06- Plug		
	08- Jam Nut Receptacle		07- Wall Mount Receptacle		
Shell Size/Insert Arr.	9-2, 9-4, 13-8, 16-12				
Contact Type	P - Pin Termini S - Socket Termini				
Key Polarization	A, B, C, D (See Table). Omit for 9-2 Arrangement which has 2 Keys/Keyways only.				

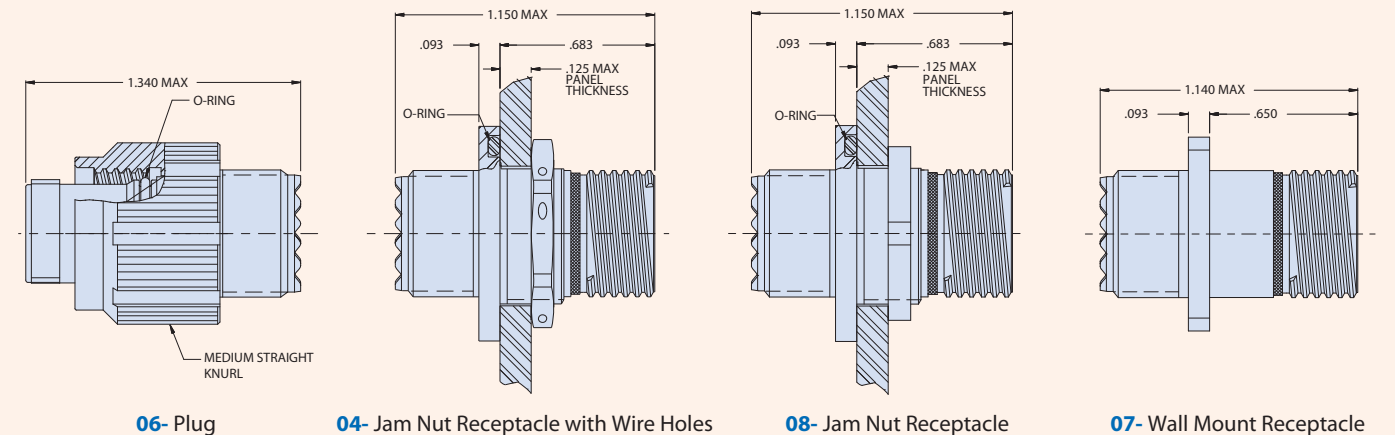

Key Polarization		
Position	A°	B°
A	150°	210°
B	75°	210°
C	95°	230°
D	140°	275°

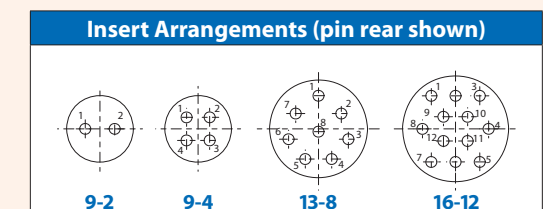

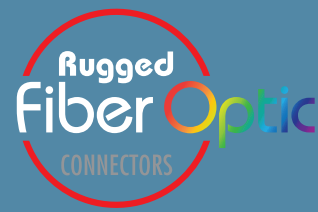

PIN TERMINI

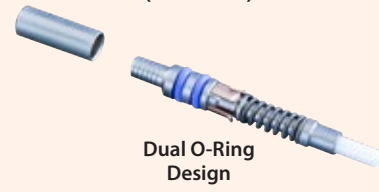
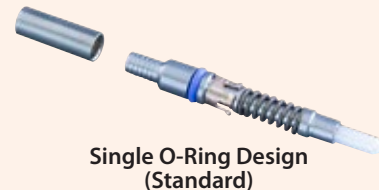

SOCKET TERMINI

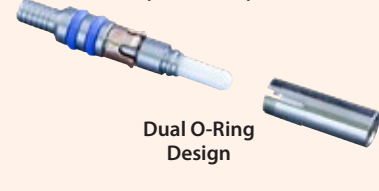

DUMMY TERMINUS



How To Order GFR Fiber Optic Termini				
Sample Part Number	181-011	-126	K	D
Series	181-012 GFR front-release pin terminus 181-011 GFR front-release socket terminus			
Dash No.	Dash No.	Ferrule Hole Ø	Typical Fiber Type	Typical Fiber Size core/cladding/coating
	-125	125.0 µm	Single Mode	9/125 µm
	-126S	126.0 µm	Single Mode	9/125 µm
	-126	126.0 µm	Multi Mode	50/125, 62.5/125 µm
	-142	142.0 µm	Multi Mode	100/140 µm
	-156	156.0 µm	Multi Mode	62.5/125/155 µm (Polyimide)
	-173	173.0 µm	Multi Mode	100/140/172 µm (Polyimide)
	-175	175.0 µm	Multi Mode	100/140/172 µm (Polyimide)
	-231	231.0 µm	Multi Mode	200/225 µm
	-236	236.0 µm	Multi Mode	200/230 µm
-286	286.0 µm	Multi Mode	200/280 µm	
-448	448.0 µm	Multi Mode	400/440 µm	
Alignment Sleeve (socket only)	K = Stainless Steel Sleeve Omit = Ceramic Sleeve (standard) Omit designator for pin terminus			
O-Ring Option	D = Dual O-Rings Omit = Single O-Ring (standard)			

Dummy Terminus	
181-051	Size 16 Dummy Terminus for GFR Connectors

TERMINI MATERIAL AND FINISH

Ferrule: Zirconia Ceramic
 Alignment Sleeve (socket): Zirconia Ceramic or Stainless Steel/Passivate
 Protective Cover (socket): BeCu Alloy/Nickel
 Body: Stainless Steel/Passivate
 Spring (pin): Stainless Steel/Passivate
 Bushing (pin): Stainless Steel/Passivate
 Retention Clip: BeCu Alloy
 O-Ring(s): Fluorosilicone
 Crimp Sleeve: Brass Alloy/Nickel

NOTES

Crimp sleeves are supplied with terminus assemblies. Spares may be ordered separately. See Glenair GAP-031 and GAP-031B for termination and assembly tools/procedures.

Table II: Tools and Accessories	
182-0055	Polishing Tool, socket
182-005P	Polishing Tool, pin
182-012	Crimp Tool
182-013	Insertion Tool, Straight
182-014	Insertion Tool, 90 Degree
182-015	Removal Tool
182-016	Insertion/Removal Tool, Alignment Sleeve, socket
181-011-S	Protective Cover with Ceramic Sleeve
181-011-K	Protective Cover with Stainless Steel Sleeve
265-002	Crimp Sleeve, Ø 2.2mm Max Jacket

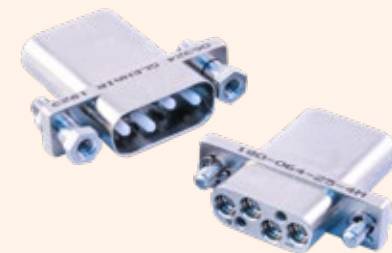

Avoid damage! Consult the factory for mating / unmating instructions

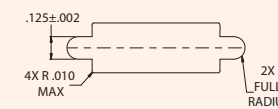

Recommended Panel Cutout



Avoid damage! Consult the factory for mating / unmating instructions

How To Order GFR Micro-D Connectors				
Sample Part Number	180-064	-25	-4	M
Series	180-064 GFR Micro-D Plug 180-063 GFR Micro-D Receptacle			
Shell Size	-9 (1 terminus max) -15 (2 termini max) -21 (3 termini max) -25 (4 termini max) -31 (5 termini max) -100 (8 termini max)			
No. of Termini	1, 2, 3, 4, 5, 8			
Material / Finish	C	Aluminum Alloy	Anodize, Black	
	M		Electroless Nickel	
	NF	CAD/Olive Drab over Electroless Nickel		
	ZN	Zinc-Nickel/Olive Drab over Electroless Nickel		
	ZI	Stainless Steel	Passivate	

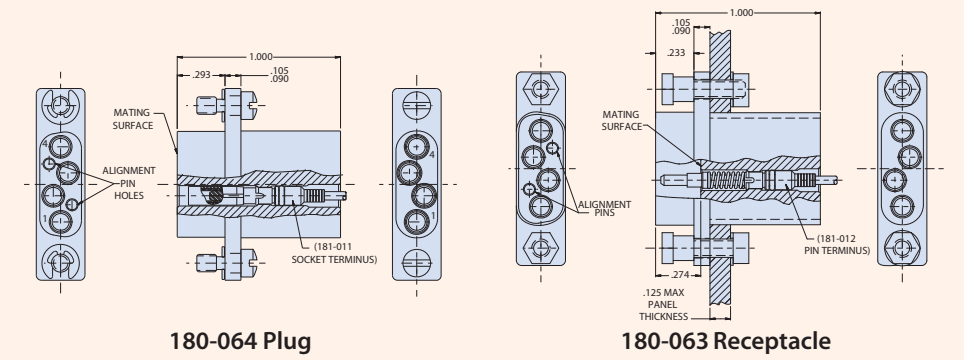

180-064 Plug

180-063 Receptacle

How To Order GFR D-Subminiature Connectors				
Sample Part Number	180-066	-15	-5	-M
Series	180-066 GFR D-Sub Plug 180-065 GFR D-Sub Receptacle			
Shell Size	-9 (4 termini max) -15 (5 termini max) -25 (8 termini max) -50 (12 termini max)			
No. of Termini	4, 5, 8, 12			
Material / Finish	C	Aluminum Alloy	Anodize, Black	
	M		Electroless Nickel	
	NF	CAD/Olive Drab over Electroless Nickel		
	ZN	Zinc-Nickel/Olive Drab over Electroless Nickel		
	ZI	Stainless Steel	Passivate	

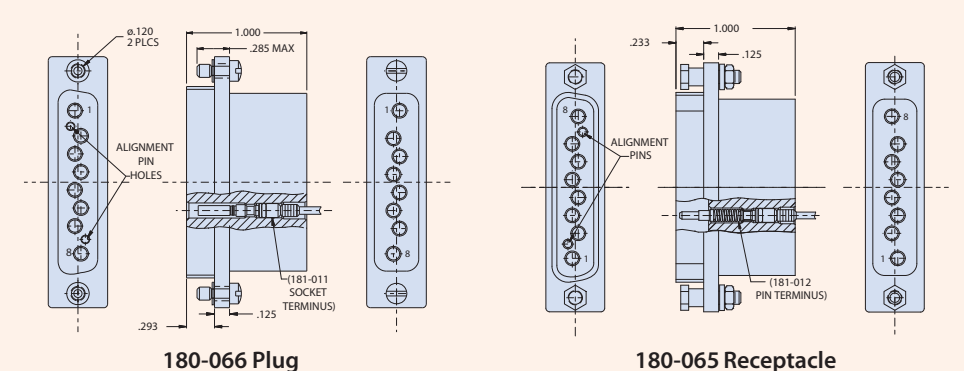

180-066 Plug

180-065 Receptacle

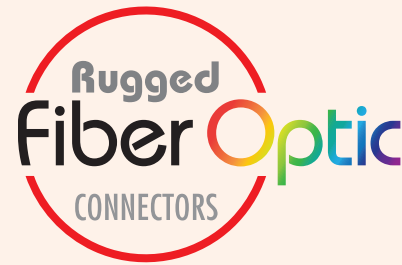

Rugged high-density MT Ferrule fiber optic connection system—with mil-grade SuperNine® or Series 791 packaging



Rugged performance MT ferrules in MIL-DTL-38999 advanced-performance connectors or in precision-machined Series 791 rectangular—only from Glenair

- SuperNine with MT
- Ruggedized “better than QPL” SuperNine® MIL-DTL-38999 Series III type interconnect packaging
- Singlemode and multimode fiber
- Low insertion loss
- Environmental sealing: IP67 mated, IP68 available at interface
- RoHS-compliant finishes available
- MT ferrules sold separately
- MT assembly tool, P/N 182-062 also available and sold separately

The MT Ferrule High-Density Advantage



24 fibers

Up to 24 fibers in a single compact, lightweight ferrule (7mm x 3mm / .276" x .118")—same real estate as three size #16 termini side by side

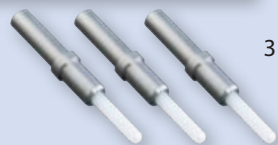

3 fibers

ULTRA HIGH-DENSITY
MT Ferrule



Signature fiber optic connection system: SuperNine D38999 and Series 791 Rectangular

SUPERNINE® MT CONNECTOR SIZES AND INSERT ARRANGEMENTS

SuperNine® MT MIL-DTL-38999 Series III type connectors with plug-and-play MT ferrule accommodation			
<p>CONNECTOR MASTER KEY</p> <p>2X GUIDE PIN</p>			<p>4X GUIDE PIN</p>
<p>Shell Size 11</p> <p>Insert Arrangement -1</p> <p>Up to 24 fibers (1 MT ferrule)</p>	<p>Shell Size 13</p> <p>Insert Arrangement -2</p> <p>Up to 48 fibers (2 MT ferrules)</p>	<p>Shell Size 15</p> <p>Insert Arrangement -3</p> <p>Up to 72 fibers (3 MT ferrules)</p>	<p>Shell Size 17</p> <p>Insert Arrangement -4</p> <p>Up to 96 fibers (4 MT ferrules)</p>

SERIES 791 WITH MT

Series 791 MT fiber optic connector is the world's smallest ruggedized MT connector solution with robust resistance to vibration and shock. Series 79 MT delivers superior low insertion-loss performance (up to 500 mating cycles) compared to commercial solutions. Connectors are supplied in single (consult factory for dual and quad) MT configurations with retaining plate and optional banding porch on plugs, and ultra low-profile retaining plate on receptacles.

SERIES 791 PRECISION-MACHINED SPACE-GRADE MT FERRULE-EQUIPPED CONNECTORS

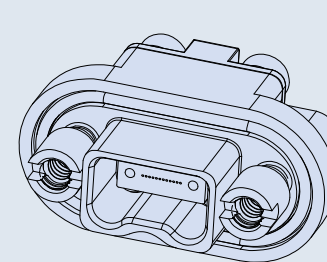

Receptacle with female MT ferrule available with or without EMI gasket

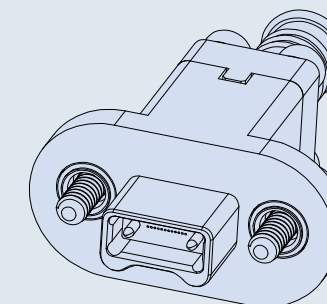

Plug with male MT ferrule with retaining plate and banding porch

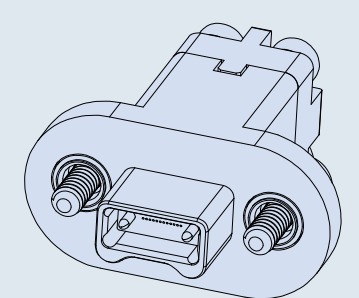

Plug with male MT ferrule and retaining plate

- Ruggedized small form-factor, high-density MT fiber optic solution
- Temperature tolerance from -40°C to +85°C
- Optimized for use with parallel optic transceivers in ribbon or round cable applications
- Low insertion loss performance in high vibration and shock environments



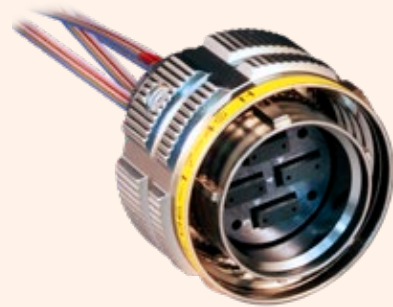
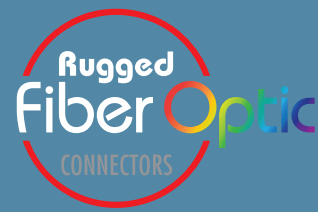

SuperNine MT Cable Plug						
Sample Part Number	183-001	ME	G6	-17-4	S	N
Basic Part Number	MT Ferrule Fiber Optic Connector					
Material/Finish Code	See Table I					
Connector Style	G6 = Plug with EMI/RFI ground spring					
Shell Size / Insert Arrangement	11-1, 13-2, 15-3, 17-4					
Insert Designator	S = Socket insert (plug only)					
Alternate Key Position	A, B, C, D, E, N = Normal (per MIL-DTL-38999)					



SuperNine MT Jam Nut Mount Receptacle						
Sample Part Number	183-001	ME	08	-17-4	P	N
Basic Part Number	MT Ferrule Fiber Optic Connector					
Material/Finish Code	See Table I					
Connector Style	08 = Jam nut receptacle					
Shell Size / Insert Arrangement	11-1, 13-2, 15-3, 17-4					
Insert Designator	P = Pin insert (receptacle only)					
Alternate Key Position	A, B, C, D, E, N = Normal (per MIL-DTL-38999)					



SuperNine MT In-Line Receptacle						
Sample Part Number	183-001	ME	05	-17-4	P	N
Basic Part Number	MT Ferrule Fiber Optic Connector					
Material/Finish Code	See Table I					
Connector Style	05 = In-line receptacle					
Shell Size / Insert Arrangement	11-1, 13-2, 15-3, 17-4					
Insert Designator	P = Pin insert (receptacle only)					
Alternate Key Position	A, B, C, D, E, N = Normal (per MIL-DTL-38999)					

Table I - Material and Finish		
Code	Material	Finish Description
ME	Aluminum Alloy	Electroless Nickel
MT		Nickel-PTFE, Grey
NF		Cadmium, Olive Drab
ZR		Zinc-Nickel, Black
XM	Composite	Electroless Nickel
XW		Cadmium, Olive Drab
Z1	Stainless Steel	Passivate
ZL		Electro-Deposited Nickel



SuperNine MT Wall-Mount Receptacle, Standard Holes						
Sample Part Number	183-001	ME	H7	-17-4	P	N
Basic Part Number	MT Ferrule Fiber Optic Connector					
Material/Finish Code	See Table I					
Connector Style	H7 = Wall-mount receptacle with round holes					
Shell Size / Insert Arrangement	11-1, 13-2, 15-3, 17-4					
Insert Designator	P = Pin insert (receptacle only)					
Alternate Key Position	A, B, C, D, E, N = Normal (per MIL-DTL-38999)					



SuperNine MT Wall-Mount Receptacle, Slotted Holes						
Sample Part Number	183-001	ME	S7	-17-4	P	N
Basic Part Number	MT Ferrule Fiber Optic Connector					
Material/Finish Code	See Table I					
Connector Style	S7 = Wall-mount receptacle with slotted holes					
Shell Size / Insert Arrangement	11-1, 13-2, 15-3, 17-4					
Insert Designator	P = Pin insert (receptacle only)					
Alternate Key Position	A, B, C, D, E, N = Normal (per MIL-DTL-38999)					

Table I - Material and Finish		
Code	Material	Finish Description
ME	Aluminum Alloy	Electroless Nickel
MT		Nickel-PTFE, Grey
NF		Cadmium, Olive Drab
ZR		Zinc-Nickel, Black
XM	Composite	Electroless Nickel
XW		Cadmium, Olive Drab
Z1	Stainless Steel	Passivate
ZL		Electro-Deposited Nickel

MT FERRULE KIT

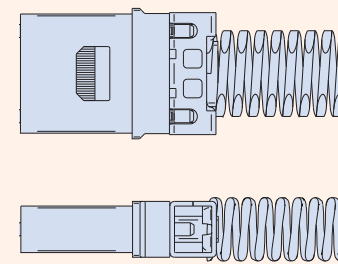

How To Order MT Ferrules				
Sample Part Number	181-108	-1253	-12	S
Basic Part Number	MT Ferrule kit			
Fiber type	-1253 = Singlemode -126 = Multimode			
Number of Fibers	-12 (12 fibers, available in singlemode and multimode) -24 (24 fibers, available in multimode only)			
Ferrule Style	S = Female (Plug Only) P = Male (Recp Only)			

Material/Finish

- Ferrule: Polyphenylene Sulfide Resin
- Spacer, Female: High-grade engineering plastic
- Spring: Stainless Steel
- Boot: TPE

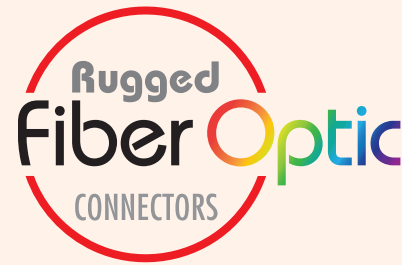

**Rugged High-Density
MT Ferrule Fiber Optic
Connection System—
With Mil-Grade Miniature
Series 79 Packaging**



**Single-ferrule high-density
MT datalinks in Glenair
Signature Series
79 rectangular
packaging
optimize SWaP in
mission-critical
mil-aero
applications**



Connector series supports both ribbon and round cable, as well as standard and expanded-beam MT ferrules

- **Small form-factor, high-density fiber optic solution for rugged mil-aero applications**
- **Temperature tolerance from -40°C to +85°C**
- **Optimized for use with parallel optical transceivers in ribbon or round cable applications**
- **Designed for optimal low insertion loss performance in high vibration and shock environments**

**ULTRA HIGH-DENSITY
Rugged MT Fiber Optic Connectors**



**Signature fiber optic connection system:
miniature Series 79 packaging**

ABOUT SERIES 79 MT FIBER OPTIC CONNECTORS

Designed in accordance with rugged mil-aero industry specifications, the Glenair Series 79 MT fiber optic connector is the world's smallest ruggedized MT connector solution. High-density MT ferrules are packaged in precision-machined rectangular aluminum shells with electroless nickel finish, or passivated stainless steel shells for higher temperature applications. Receptacles may be equipped with optional EMI gaskets, and mate bottom-to-bottom with plug assemblies for robust resistance to vibration and shock. Designed for harsh-environment, inside-the-box use in parallel optics, fiber optic backplanes, missile systems, spacecraft and satellites, heads-up displays, and other ribbonized or flex-circuit fiber optic datalinks, the Series 79 MT delivers superior low insertion-loss performance (up to 500 mating cycles). Connectors are supplied in single (consult factory for dual and quad) MT configurations with banding platform or ultra low-profile retaining plate options.

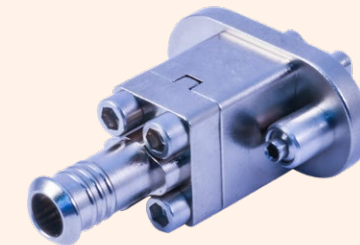

-06 plug, with retaining plate for EMI shield termination and strain relief of ribbon or round fiber cable



-S7 receptacle with standard retaining plate



-S7 receptacle with conductive EMI gasket

The MT Ferrule High-Density Advantage



Up to 24 fibers in a single compact, lightweight ferrule (7mm x 3mm / .276" x .118")—same real estate as three size #16 termini side by side

PARALLEL OPTICAL TRANSCEIVERS



Glenair's rugged, small form-factor parallel optical transceivers are the ideal solution for board-level optical-to-electrical conversion utilizing MT fiber optic ferrules.

Series 79 MT Ferrule Fiber Optic Connector Performance Specifications per QTP-773 and Test Report GT-19-111	
Test Description	Test Results
Optical Insertion Loss, multimode (consult factory for singlemode)	50/125 μm fiber @ 850 nm: ≤0.15 dB average; 0.31 dB typical 50/125 μm fiber @ 1300 nm: ≤0.21 dB average; 0.38 dB typical
Temperature Cycling: per TIA/EIA-455-3, Test Condition C-2	- 40°C to +85°C, 5 Cycles, 56 hours Max. CIT = .25 dB; Max. IL post-test = .30 dB
Mating Durability	First 100 cycles with CIT measured every 10 cycles Max. CIT = 0.12 dB; Max. IL post-test = 0.20 dB
Mating Durability, Extended	From 101st cycle to 500th cycle with CIT measured every 25 cycles Max. CIT = 0.21 dB; Max. IL post-test = 0.30 dB
Physical Shock 1: 50g Peak, 11 ms duration, per TIA/EIA-455-14, Test Condition E	Max. CIT = 0.14 dB; Max. IL post-test = 0.42 dB; discontinuity ≤0.5 dB @ <1 us.
Physical Shock 2: 160g Peak, 4 ms duration, per MIL-STD-202, Method 213	Max. CIT = 0.04 dB; Max. IL post-test = 0.40 dB; discontinuity ≤0.5 dB @ <1 us.
Additional Physical Shock: 300g Peak, 0.5 ms duration, per MIL-STD-833E, Method 2002.4 (30 shocks total)	Max. CIT = .15 dB; Max. IL post-test = 0.20 dB; discontinuity ≤0.5 dB @ <1 us.
Vibration 1: 5-15 Hz, .12" double amplitude, 2 hours/axis (6 hours total) per MIL-STD-202, test condition 201, Sinusoidal	Max. CIT = 0.06 dB; Max. IL post-test = 0.37 dB
Vibration 2: 20g Peak, 10-2,000 Hz, 4 hours/axis (12 hours total) per TIA-455-11, Test Condition IV, Sinusoidal	Max. CIT = 0.08 dB; Max. IL post-test = 0.43 dB
Weight	Plug with Ferrule kit 5.5 grams · Receptacle with Ferrule kit 7.5 grams

SERIES 79 MINIATURE MT Fiber Optic Connectors

How To Order Series 791 MT Ferrule Fiber Optic connectors

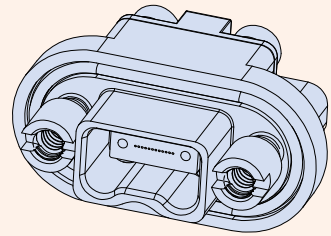

Receptacle with female MT ferrule,
available with or without EMI gasket

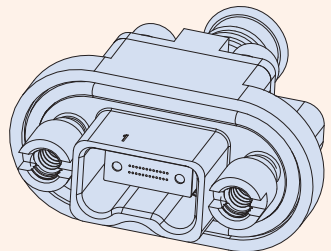

Receptacle with female MT ferrule,
retaining plate, and banding
platform

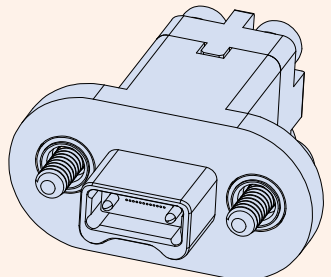

Plug with male MT ferrule and
retaining plate

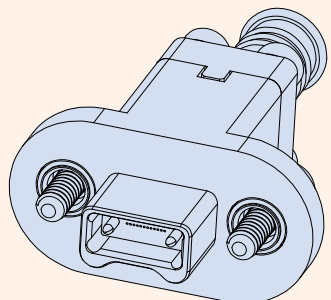

Plug with male MT ferrule with
retaining plate and banding
platform

How To Order Glenair 183-003 Series 79 MT Fiber Optic Connectors	
Sample Part Number	183-003 ME -06 -L -1
Basic Number	Series 79 Single MT Fiber Optic Connector
Material / Finish	ME = Al Alloy / Electroless Nickel ZR = Al Alloy / Zinc Nickel, Black NF = Al Alloy / Cadmium, O.D. Z1 = Stainless Steel / Passivate
Connector Type	-06 = Plug (used with male MT ferrule) -07 = Receptacle (used with female MT ferrule) -S7 = Receptacle with EMI gasket (used with female MT ferrule)
Mounting Hardware	Hardware for PLUGS Rear Panel Mount Jackposts for RECEPTACLES: -L = Hex Head Jackscrew, non-removable -B = Thru-Hole -X = for .031" panel thickness -W = for .047" panel thickness -V = for .062" panel thickness -T = for .094" panel thickness
Retaining Plate / Banding Platform	-1 = 12 or 24 channel without banding platform -2 = 12 or 24 channel with banding platform for EMI shield termination and strain relief

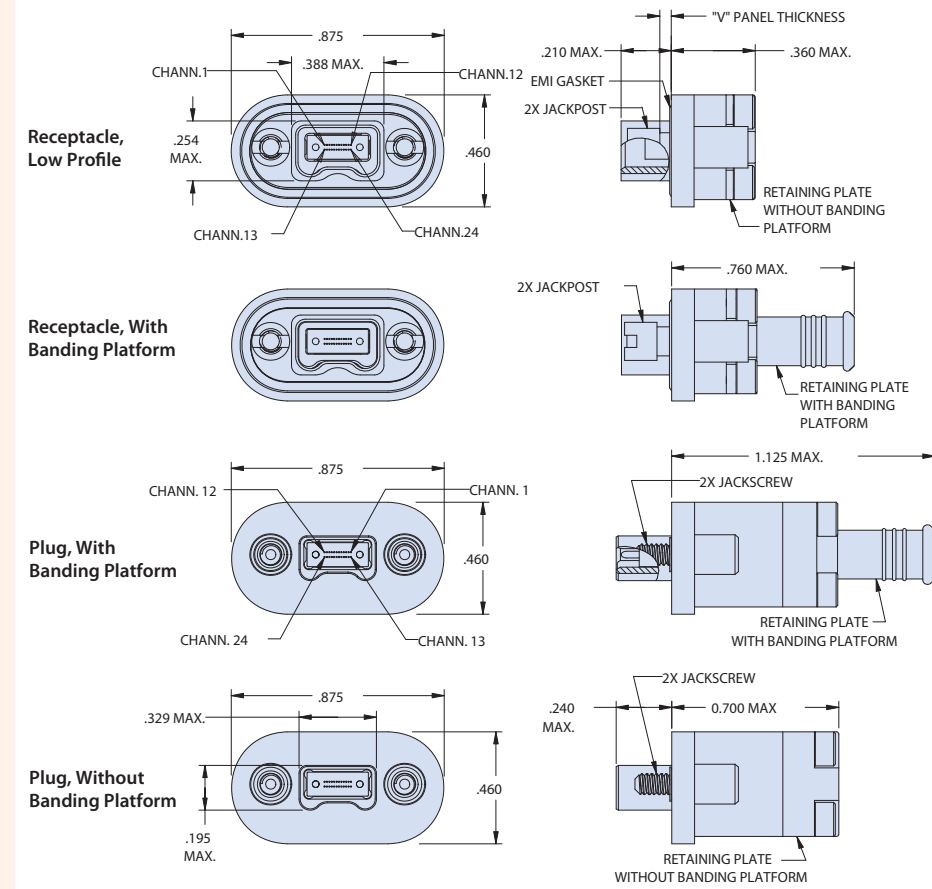

MATERIAL/FINISH/NOTES
 Mounting hardware: stainless steel / passivated
 EMI gasket (optional): conductive silicone
 Additional materials, finishes, connector configurations (dual and quad layouts), and hardware options are available, consult factory

SERIES 79 MINIATURE MT Fiber Optic Connectors

How To Order MT Ferrule Kits and Series 79 MT to MT Ferrule Cable Assembly

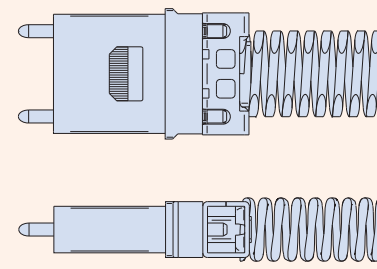

How To Order MT Ferrule Kits	
Sample Part Number	181-133 -126 -12 P
Basic Part Number	MT Ferrule kit
Fiber type	-126, -1253, -1253A (See Table I)
Number of Fibers	-12, -24 (See Table I)
Ferrule Style	P = Male (use with Plug) S = Female (use with Receptacle)

Table I						
Dash No.	Fiber Type	End Face	Fiber Size Core/Cladding	No. of Fibers	Ferrule Identification	Pin Clamp Identification (Male Kit only)
-126	MM	PC	50/125 62.5/125	12 24	M-ME12 M-ME24	1 Through Hole
-1253	SM	PC	9/125	12	E-E12	2 Through Holes
-1253A	SM	APC	9/125	12	E-E12	2 Through Holes

MATERIAL/FINISH

- Ferrule: Polyphenylene Sulfide Resin
- Pin Clamp, Spring: Stainless Steel
- Boot: TPE

How To Order Series 79 MT Ferrule Fiber Optic Cable Assemblies	
Sample Part Number	FA07364 -06 -17 ME -B4 -50 -L -1 -0036 -L
Basic Number	Series 79 MT Ferrule Fiber Optic Cable Assembly
A Connector Type	-06 = Sr. 79 Plug (used with male MT ferrule) -07 = Sr. 79 Receptacle (used with female MT ferrule) -S7 = Sr. 79 Receptacle with EMI gasket (used with female MT ferrule)
B Connector Type	-06 = Sr. 79 Plug (used with male MT ferrule) -07 = Sr. 79 Receptacle (used with female MT ferrule) -S7 = Sr. 79 Receptacle with EMI gasket (used with female MT ferrule) -12 = ST Connector -13 = FC Connector -14 = SC Connector -15 = GC Connector -16 = LC Connector -17 = MT Connector (male) -18 = MT Connector (female) -19 = MTP Connector (male) -20 = MTP Connector (female)
Material / Finish (-06, -07, -S7)	ME = Al Alloy, Electroless Nickel NF = Al Alloy, Cad/Olive Drab ZR = Al Alloy, Zinc-Nickel, Black Z1 = Stainless Steel, Passivate
Fiber Qty. / Type	-B2 = 12 bare ribbon fibers -B4 = 24 bare ribbon fibers (Multimode only) -R2 = 12 round ribbon fibers -R4 = 24 round ribbon fibers (Multimode only)
Fiber Size	-09 = 9.3/125 Singlemode -50 = 50/125 Multimode -62 = 62.5/125 Multimode
Mounting Hardware	Plug -L = Hex head jackscrew, non-removable -B = Thru-hole Receptacle -X = Rear-panel jackpost, .031" thickness -W = Rear-panel jackpost, .041" thickness -V = Rear-panel jackpost, .062" thickness -T = Rear-panel jackpost, .094" thickness
Banding Platform (-06, -07, -S7)	-1 = without banding platform -2 = with banding platform
Length	In inches (e.g. -0036 = 36 inches)
Protective Cover	L = supplied less covers Omit = supplied with covers

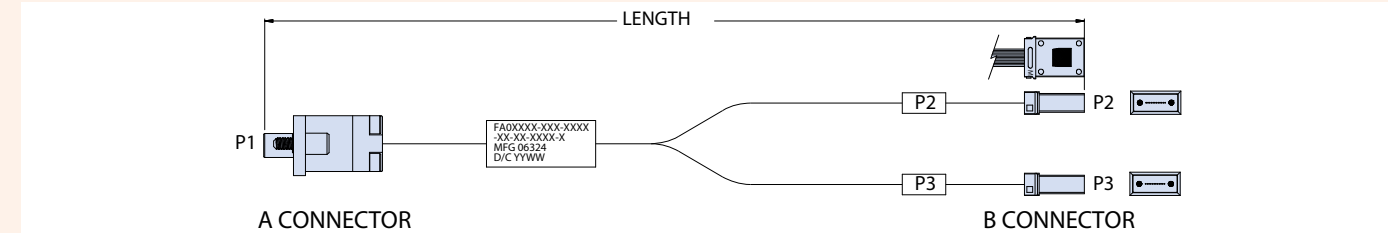

Optical performance note: Insertion loss to be less than 1.5 dB when measured at 1310 nm wavelength for singlemode, or when measured at 850 nm for multimode



MISSION-CRITICAL INTERCONNECT SOLUTIONS

Glenair, Inc.

1211 Air Way • Glendale, California • 91201-2497

Telephone: 818-247-6000 • Fax: 818-500-9912 • sales@glenair.com

www.glenair.com

Glenair Power Products Group

20 Sterling Drive
Wallingford, CT
06492

Telephone:
203-741-1115
Facsimile:
203-741-0053
sales@glenair.com

Glenair UK Ltd

40 Lower Oakham Way
Oakham Business Park
Mansfield, Notts
NG18 5BY England

Telephone:
+44-1623-638100
Facsimile:
+44-1623-638111
sales@glenair.co.uk

Glenair Microway Systems

7000 North Lawndale Avenue
Lincolnwood, IL
60712

Telephone:
847-679-8833
Facsimile:
847-679-8849

Glenair Nordic AB

Gustav III : S Boulevard 42
SE-169 27 Solna
Sweden

Telephone:
+46-8-50550000
sales@glenair.se

Glenair GmbH

Schaberweg 28
61348 Bad Homburg
Germany

Telephone:
06172 / 68 16 0
Facsimile:
06172 / 68 16 90
info@glenair.de

Glenair Iberica

C/ La Vega, 16
45612 Velada
Spain

Telephone:
+34-925-89-29-88
Facsimile:
+34-925-89-29-87
sales@glenair.es

Glenair Italia S.p.A.

Via Del Lavoro, 7
40057 Quarto Inferiore –
Granarolo dell'Emilia
Bologna, Italy

Telephone:
+39-051-782811
Facsimile:
+39-051-782259
info@glenair.it

Glenair France SARL

7, Avenue Parmentier
Immeuble Central Parc #2
31200 Toulouse
France

Telephone:
+33-5-34-40-97-40
Facsimile:
+33-5-61-47-86-10
sales@glenair.fr

Glenair Korea

6-21Tapsil-ro 58beon-gil
Giheung-gu, Yongin-si
Gyeonggi-do
Republic of Korea

Telephone:
+82-31-8068-1090
Facsimile:
+82-31-8068-1092
sales@glenair.kr