

MISSION-CRITICAL
INTERCONNECT
SOLUTIONS



SERIES 96

TurboFlex[®]

Ultra-Flexible Power Distribution Cables and Turnkey High-Voltage Cable Assemblies with Glenair Signature Connectors

MARCH 2024



Ultra-flexible and rugged power distribution cables and high-voltage cable assemblies



Power distribution cables present a unique challenge to electrical wire interconnect system engineers. Typically fabricated from stiff, non-flexible conductors and jackets with extremely large bend radii, such cables are heavy, hard to route, and prone to insulation damage from weathering and abrasion. TurboFlex® power distribution cables—and complex high-voltage cable assemblies—are constructed from high strand-count rope-lay inner conductors made with tin, nickel, or silver-plated copper, nickel-plated aluminum, or bare copper. These highly-flexible conductors, combined with Glenair's high-performance Duraelectric™ insulation result in cables ideally suited for applications where flexibility, durability, and weight reduction are required. The signature Duraelectric™ insulation compound provides outstanding resistance to temperature extremes, ozone exposure, caustic chemicals including jet fuel, gamma radiation, and other forms of environmental and mechanical damage. Long life and performance are critical in power distribution applications. TurboFlex, with its flexible conductors and Duraelectric™ jacketing delivers both.



- Ultra-flexible rope-lay power cable construction
- Turnkey high-voltage cable assemblies with Glenair signature connectors
- Broad range of gauges from 20 AWG to 450 MCM
- Low-smoke, zero halogen, and RoHS compliant



- High-performance Duraelectric™ D jacketing standard
- Lightweight (L), radiation-resistant/low-temperature (K), jet fuel/chemical-resistant (F), and high-conductivity (C)



Ultra-flexible rope-lay construction



Wire rope assemblies for equipment grounding



Available in turnkey high-voltage cable assemblies

Product selection guide

COPPER CORE	GENERAL-DUTY	TurboFlex copper core, imperial or metric gauge, with Duraelectric™ D insulation for optimal UV/sunlight, fire, ozone, fluid and caustic chemical resistance.	13–23
	HIGH-POWER SHIELDED	TurboFlex copper core, imperial gauge, with Duraelectric™ D jacket and braided ground shield for high-power applications.	24–33
	HIGH-POWER SHIELDED(SWaP)	TurboFlex copper core, imperial gauge, with Duraelectric™ D jacket and lightweight braided ground shield for high-power / SWaP applications.	34–41
	ABRASION-RESISTANT / HIGH-TEMP	TurboFlex copper core, imperial gauge, with Duraelectric™ D insulation. Fabric overbraiding for additional abrasion and heat protection.	42
	HIGH-VOLTAGE / HIGH-POWER	TurboFlex copper core, imperial gauge, with Duraelectric™ L jacket, braided ground shield, and three layers of conductive/insulating Duraelectric materials for high-voltage, high-power applications.	44
	LIGHTWEIGHT INSULATION	TurboFlex copper core, imperial gauge, with Lightweight Duraelectric™ L insulation for weight savings and outstanding abrasion protection.	46
	LOW-TEMP / RAD-RESISTANT	TurboFlex copper core, imperial gauge, with ultra low temperature/gamma radiation resistant Duraelectric™ K insulation for space-grade applications.	47
	SWAMP ZONE FUEL-RESISTANT	TurboFlex copper core, imperial gauge, with harsh-environmental (SWAMP-zone) Duraelectric™ F for chemical/jet fuel resistance and low-temperature flexibility.	48
	UL-RECOGNIZED	TurboFlex copper core, imperial gauge, with Duraelectric™ D insulation. UL Recognized IAW UL 758 Style 3644.	49–50
3-PHASE POWER SYMMETRIC	Multi-conductor TurboFlex designs for 3-phase power applications. Copper core. Duraelectric™ D jacket. Optional high-temp tolerant Nomex® braid.	51–53	
ALUMINUM CORE	GENERAL-DUTY	TurboFlex aluminum core, imperial gauge, with Duraelectric™ D insulation for optimal UV/sunlight, fire, ozone, fluid and caustic chemical resistance.	54–57
	HIGH-POWER SHIELDED	TurboFlex aluminum core, imperial gauge, with Duraelectric™ D jacket and braided ground shield for high-power applications.	58–65
	HIGH-POWER SHIELDED(SWaP)	TurboFlex aluminum core, imperial gauge, with Duraelectric™ D jacket and lightweight braided ground shield for high-power / SWaP applications.	66–73
	ABRASION-RESISTANT / HIGH-TEMP	TurboFlex aluminum core, imperial gauge, with Duraelectric™ D insulation. Fabric overbraiding for additional abrasion and heat protection.	74
	LIGHTWEIGHT INSULATION	TurboFlex aluminum core, imperial gauge, with Lightweight Duraelectric™ L insulation for weight savings and outstanding abrasion protection.	76
ANCILLARY PRODUCTS	GROUND STRAPS AND BONDS	TurboFlex rope-lay wire grounding strap. Copper/tin plated per B545; copper/silver or copper/nickel plated. Full complement of Duraelectric sleeve materials/colors.	79
	TERMINAL LUGS	Precision-machined high-conductivity copper alloy terminal lugs, purpose-built to fit TurboFlex high-flexibility power distribution cables.	82
	AUTOSHRINK™ SLEEVES	Cold-action straight-wall tubing, standard and small-diameter	84–85

SELECTION GUIDE

TURNKEY
SOLUTIONS FOR
HIGH POWER
ELECTRICAL
DISTRIBUTION



The TurboFlex® Ecosystem: High-Power/High-Voltage
Cables, Contacts, Connectors, and Assemblies



TURNKEY
turboflex
Flexible Cable Assemblies

TurboFlex is an ultra-flexible and rugged power cable solution—ideal for high-voltage electrical distribution and propulsion applications such as battery plant-to-inverter-to-electric motor cables for eVTOL aircraft. Constructed from rope-lay configuration copper or aluminum wire and jacketed with Glenair signature Duralectric insulation, TurboFlex cables are optimized for use in an ecosystem of Glenair signature contact and connector technologies. Turnkey connectorized or lugged cable assemblies — fully tested and ready for immediate use — provide reliable high-temperature tolerant performance up to 4500 VAC.



◀ Duralectric™ is the high-performance TurboFlex® jacketing material. Different compounding formulas are optimized for weight savings, radiation resistance, ultra low temperatures, conductivity, and immersion in chemical or caustic fuels. Available in a broad range of colors including safety orange.

**STANDARD TURBOFLEX
VS. TURBOFLEX M**

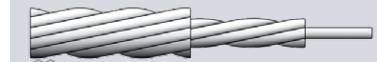

M22759 wire construction



TurboFlex rope-lay
wire construction

TurboFlex cables are jacketed with Duralectric insulation, which contributes significantly to the flexibility of the product. Available wire cores include rope-lay (standard) for maximum flexibility, and M22759 wire (TurboFlex M) with the flight-heritage of a mil-spec core and a slightly larger bend radius, but far superior flexibility compared to standard M22759 wire.

Standard M22759
mil-spec wire

TurboFlex M:
mil-spec core,
Duralectric
jacket

Ultra-flexible
TurboFlex
rope-lay wire

Ecosystem Overview

THE TURBOFLEX ECOSYSTEM: HIGH-TEMPERATURE TOLERANT CROWN RING CONTACTS



Glenair Signature Crown Ring high temperature tolerant contacts

provide reduced contact resistance, superior conductivity, and higher temperature tolerance than conventional AS39029 contacts or specialized high-power contacts from other manufacturers. Safe-touch configurations available.

- Maximum operating temperature 200°C
- Superior conductivity performance compared to beryllium copper contacts, across full temperature range
- Up to 60% lower contact resistance than equivalent AS39029 contacts (normalized, less wire)
- Contact bodies made from high conductivity copper alloy (approximately 95% IACS)
- Stainless steel Crown Ring
 - Provides socket forces without stress relaxation at high temperatures
 - Moves socket spring function from socket body to ring, allowing use of high-conductivity copper
- Gold over nickel plating
 - Thicker plating than industry standards for reduced contact fretting and higher temperature endurance
 - Gold over nickel is “gold standard” for high-reliability aerospace contacts
- Crimp versions use standard industry tooling, including crimp die/locator and insertion/extraction tools (2AWG Crown Ring contacts require custom tooling)

THE TURBOFLEX ECOSYSTEM: COMPATIBLE CONNECTOR DESIGNS WITH OPTIMIZED ELECTRICAL AND ENVIRONMENTAL PERFORMANCE

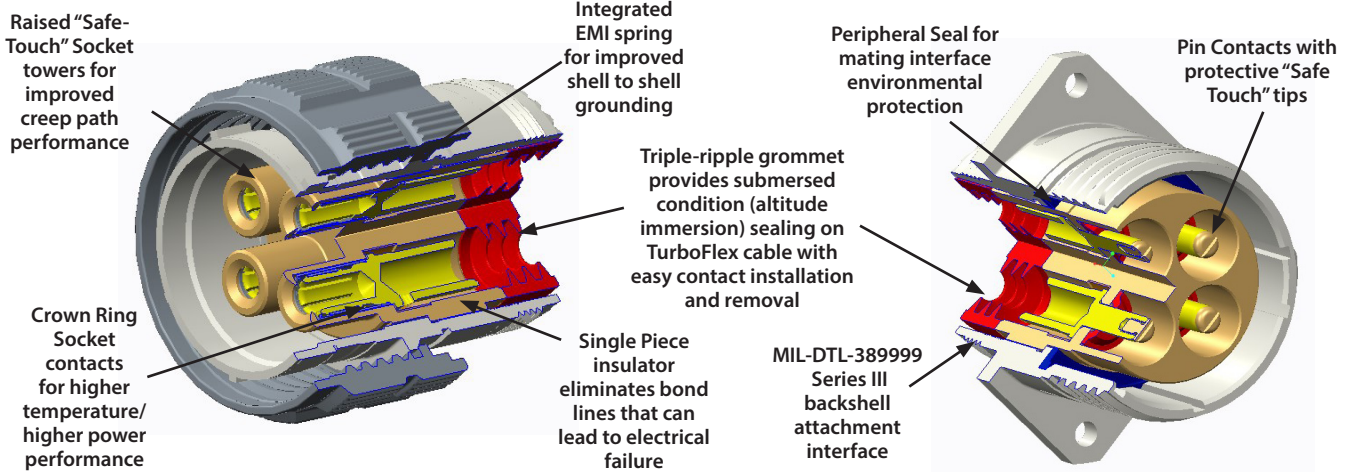

THE TURBOFLEX ECOSYSTEM: TURNKEY POWER DISTRIBUTION CONNECTOR, LUG, CABLE, AND CONTACT ASSEMBLIES—SIGNATURE HIGH-VOLTAGE DESIGNS

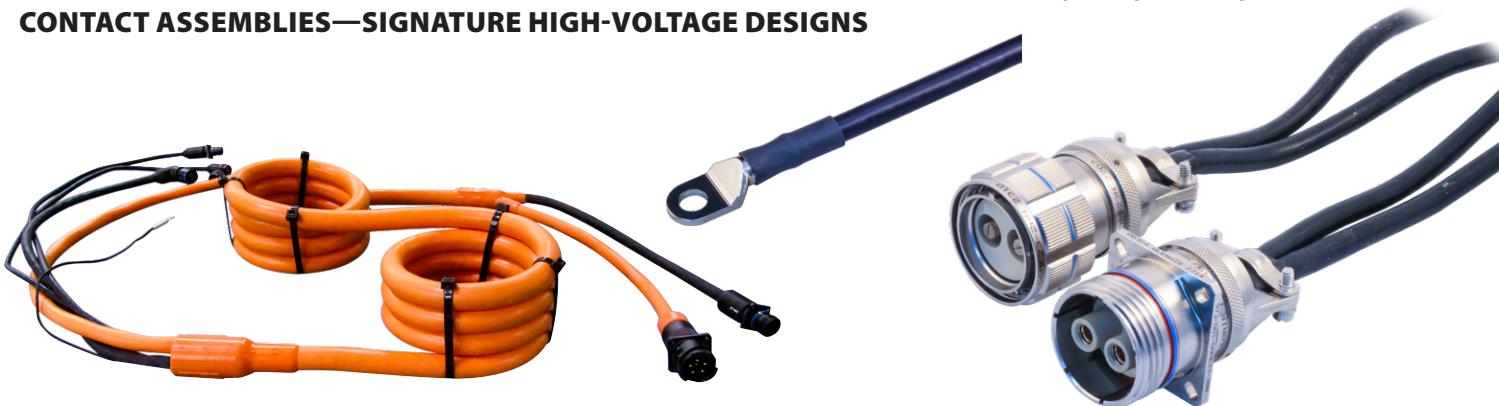

Detailed wire selection guide

WIRE SELECTION GUIDE

	CATEGORY	DESCRIPTION					
COPPER CORE	GENERAL-DUTY UNSHIELDED	TurboFlex copper core, imperial or metric gauge, with Duraelectric™ D insulation for optimal UV/sunlight, fire, ozone, fluid and caustic chemical resistance.					
	HIGH-POWER SHIELDED	TurboFlex copper core, imperial gauge, with Duraelectric™ D jacket and braided ground shield for high-power applications.					
	HIGH-POWER SHIELDED (SWaP)	TurboFlex copper core, imperial gauge, with Duraelectric™ D jacket and lightweight braided ground shield for high-power / SWaP applications.					
	ABRASION-RESISTANT / HIGH-TEMP	TurboFlex copper core, imperial gauge, with Duraelectric™ D insulation. Fabric overbraiding for additional abrasion and heat protection.					
	HIGH-VOLTAGE / HIGH-POWER	TurboFlex copper core, imperial gauge, with Duraelectric™ L jacket, braided ground shield, and three layers of conductive/insulating Duraelectric materials for high-voltage, high-power applications.					
	LIGHTWEIGHT INSULATION	TurboFlex copper core, imperial gauge, Duraelectric™ L insulation for weight savings and abrasion protection.					
	LOW-TEMP / RAD-RESISTANT	TurboFlex copper core, imperial gauge, with ultra low temperature/gamma radiation resistant Duraelectric™ K insulation for space-grade applications.					
	SWAMP ZONE FUEL-RESISTANT	TurboFlex copper core, imperial gauge, with harsh-environmental (SWAMP-zone) Duraelectric™ F for chemical/jet fuel resistance and low-temperature flexibility.					
	UL-RECOGNIZED	TurboFlex copper core, imperial gauge, with Duraelectric™ D insulation. IAW UL 758 Style 3644.					
	3-PHASE POWER SYMMETRIC	Multi-conductor TurboFlex designs for 3-phase power applications. Copper core. Duraelectric™ D jacket. Optional high-temp tolerant Nomex® braid. <table border="0" style="margin-left: 20px;"> <tr> <td></td> <td>3-phase symmetric with drain wire</td> </tr> <tr> <td></td> <td>3-phase symmetric, full-size ground</td> </tr> <tr> <td></td> <td>3-phase symmetric, full-size ground + signal wire</td> </tr> </table>		3-phase symmetric with drain wire		3-phase symmetric, full-size ground	
	3-phase symmetric with drain wire						
	3-phase symmetric, full-size ground						
	3-phase symmetric, full-size ground + signal wire						
ALUMINUM CORE	GENERAL-DUTY UNSHIELDED	TurboFlex aluminum core, imperial gauge, with Duraelectric™ D insulation for optimal UV/sunlight, fire, ozone, fluid and caustic chemical resistance.					
	HIGH-POWER SHIELDED	TurboFlex aluminum core, imperial gauge, with Duraelectric™ D jacket and braided ground shield for high-power applications.					
	HIGH-POWER SHIELDED (SWaP)	TurboFlex aluminum core, imperial gauge, with Duraelectric™ D jacket and lightweight braided ground shield for high-power / SWaP applications.					
	ABRASION-RESISTANT / HIGH TEMP	TurboFlex aluminum core, imperial gauge, with Duraelectric™ D insulation. Fabric overbraiding for additional abrasion and heat protection.					
	LIGHTWEIGHT INSULATION	TurboFlex aluminum core, imperial gauge, with Lightweight Duraelectric™ L insulation for weight savings and outstanding abrasion protection.					

Detailed wire selection guide

JACKET/INSULATION THICKNESS	VAC RATING	AWG/METRIC	AVAILABLE GAUGES (AWG OR mm ²)	P/N	PG
.125"	4500	AWG	1/0, 2/0, 3/0, 4/0, 250MCM, 350MCM, 450MCM	961-001	13
3.18mm	4500	metric	50, 70, 95, 120, 150, 185, 240, 300, 500	961-011	14
.093"	3500	AWG	8, 6, 4, 2, 1/0, 2/0, 3/0, 4/0, 250MCM, 350MCM, 450MCM	961-002	15
2.36mm	3500	metric	10, 16, 25, 35, 50, 70, 95, 120, 150, 185, 240, 300	961-012	16
.062"	3000	AWG	16, 14, 12, 10, 8, 6, 4, 2, 1/0, 2/0, 3/0, 4/0	961-003	17
1.57mm	3000	metric	4, 6, 10, 16, 25, 35, 50, 70	961-006	18
.032"	2000	AWG	20, 16, 14, 12, 10, 8, 6, 4, 2, 1/0	961-004	19
.81mm	2000	metric	1.5, 2.5, 4, 6, 8, 10, 16, 25, 35, 50	961-014	20
.032"	2000	AWG	16, 14, 12, 10, 8, 6, 4, 2, 1, 0 (TurboFlex M with M22759-type conductor)	967-011	21
.016"	1000	AWG	20, 16, 14, 12, 10, 8	961-031	22
Dual .030"/.032"	3000	AWG	12, 10, 8, 6, 4, 2, 1/0, 2/0	961-035	23
.093"	3000	AWG	16, 14, 12, 10, 8, 6, 4, 2, 1/0, 2/0, 3/0, 4/0, 250MCM, 350MCM, 450MCM	961-161	24
.062"	3000	AWG	16, 14, 12, 10, 8, 6, 4, 2, 1/0, 2/0, 3/0, 4/0, 250MCM, 350MCM, 450MCM	961-007	26
1.57	3000	metric	4, 6, 10, 16, 25, 35, 50, 70, 95, 120, 150, 185, 240	961-005	28
Dual .032"/.030"	2000	AWG	20, 16, 14, 12, 10, 8, 6, 4, 2, 1/0, 2/0, 3/0, 4/0	961-129	30
.016"	1000	AWG	20, 16, 14, 12, 10, 8, 6, 4, 2, 1/0	961-143	32
.093"	3000	AWG	16, 14, 12, 10, 8, 6, 4, 2, 1/0, 2/0, 3/0, 4/0, 250MCM, 350MCM, 450MCM	961-163	34
.062"	3000	AWG	16, 14, 12, 10, 8, 6, 4, 2, 1/0, 2/0, 3/0, 4/0, 250MCM, 350MCM, 450MCM	961-153	36
.032"	2000	AWG	20, 16, 14, 12, 10, 8, 6, 4, 2, 1/0, 2/0, 3/0, 4/0	961-155	38
.016"	1000	AWG	20, 16, 14, 12, 10, 8, 6, 4, 2, 1/0	961-157	40
.032"-.125"	2000-4500	AWG	20, 16, 14, 12, 10, 8, 6, 4, 2, 1/0, 2/0, 3/0, 4/0, 250MCM, 450MCM	961-044	42
.060" / .030" / .025" / .025"	HV / HP	AWG	8, 6, 4, 2, 1/0, 2/0, 3/0, 4/0	961-113	44
.025"	1250	AWG	16, 14, 12, 10, 8, 6, 4, 2, 1/0	961-041	46
.016"/.032"/.062"	1000-3000	AWG	20, 16, 14, 12, 10, 8, 6, 4, 2, 1/0	961-033	47
.016"/.016"	1000	AWG	20, 16, 14, 12, 10, 8, 6, 4, 2, 1/0	961-139	48
.035" - .100"	1000	AWG	20, 16, 14, 12, 10, 8, 6, 4, 2, 1/0, 2/0, 3/0, 4/0, 250MCM, 450MCM	961-065	49
	3000	AWG	16, 12, 8, 4, 1/0	960-3300	51
.062"	3000	AWG	16, 12, 8, 4, 1/0	960-3301	52
	3000	AWG	16, 12, 8, 4, 1/0	960-3302	53
.096"	3500	AWG	16, 14, 12, 10, 8, 6, 4, 2, 1/0, 2/0, 3/0, 4/0, 250MCM, 450MCM	961-165	54
.062"	3000	AWG	16, 14, 12, 10, 8, 6, 4, 2, 1/0, 2/0, 3/0, 4/0	961-062	55
.032"	2000	AWG	16, 14, 12, 10, 8, 6, 4, 2, 1/0	961-148	56
.016"	1000	AWG	16, 14, 12, 10, 8	961-151	57
.093"	3000	AWG	16, 14, 12, 10, 8, 6, 4, 2, 1/0, 2/0, 3/0, 4/0, 250MCM, 350MCM, 450MCM	961-162	58
.062"	3000	AWG	16, 14, 12, 10, 8, 6, 4, 2, 1/0, 2/0, 3/0, 4/0, 250MCM, 450MCM	961-145	60
.031"	2000	AWG	16, 14, 12, 10, 8, 6, 4, 2, 1/0, 2/0, 3/0, 4/0	961-147	62
.016"	1000	AWG	16, 14, 12, 10, 8, 6, 4, 2, 1/0	961-150	64
.093"	3000	AWG	16, 14, 12, 10, 8, 6, 4, 2, 1/0, 2/0, 3/0, 4/0, 250MCM, 450MCM	961-164	66
.062"	3000	AWG	16, 14, 12, 10, 8, 6, 4, 2, 1/0, 2/0, 3/0, 4/0, 250MCM, 450MCM	961-154	68
.032"	2000	AWG	16, 14, 12, 10, 8, 6, 4, 2, 1/0, 2/0, 3/0, 4/0	961-156	70
.016"	1000	AWG	16, 14, 12, 10, 8, 6, 4, 2, 1/0	961-158	72
.032"-.125"	2000-4500	AWG	16, 14, 12, 10, 8, 6, 4, 2, 1/0, 2/0, 3/0, 4/0, 250MCM, 450MCM	961-167	74
.025"	1250	AWG	16, 14, 12, 10, 8, 6, 4, 2, 1/0	961-042	76

WIRE SELECTION GUIDE



Test Reports

PERFORMANCE / MATERIAL SPECIFICATIONS

TURBOFLEX TEST REPORTS ON GLENAIR.COM

Visit <https://www.glenair.com/test-reports-and-technical-information> for a complete set of downloadable environmental, mechanical, electrical, and radiation test reports for the TurboFlex product line.

Test Reference	Test Type	Document Title	Date Published
GT-14-40	Mechanical, Electrical, Environmental	Turboflex® Wire Abrasion and Insulation Resistance and Voltage and Current Carry Capability Evaluation Test Report	5 May 2014
GT-15-173	Mechanical	Flex Testing of TurboFlex® Wires to AS4373 Method 704	5 Nov 2015
GT-16-153	Environmental	Qualification Test Report: Autoshrink™ Immersion Insulation Resistance Testing	7 Sep 2016
GT-16-190	Environmental	Investigative Test Report: Viton Jacketed Cables Repaired with Glenair Autoshrink™	20 Oct 2016
GT-17-181	Electrical	Wet Arc Propagation and Wet Short Circuit Testing of TurboFlex® to AS4373 Method 509 and EN3475 Method 605	17 Aug 2017
GT-18-044	Electrical	Voltage Withstand of TurboFlex® and M22759/187 at Sea Level and Altitude	6 Apr 2018
GT-21-132 Abstract	Gamma Radiation	Gamma Radiation TurboFlex® Resistance to Gamma Radiation Exposure	15 Mar 2021
GT-23-213	Mechanical, Electrical	Life Cycle Testing of TurboFlex® Wire at 270°C	11 Oct 2023

TurboFlex® Aluminum and Copper comparison tables

COMPARISON OF ALUMINUM AND COPPER WIRE MATERIALS IN TURBOFLEX® CABLES

The tables below provide a comparison of Glenair TurboFlex® wires with copper and aluminum conductors. Reference Glenair Test Reports GT-15-189 and RdP 010-15.

Wire Weight by Size			
AWG	Aluminum, lbs/1000 ft	Copper, lbs/1000 ft	Aluminum Weight Savings
16	8	14	45%
12	15	29	49%
10	22	44	50%
8	33	67	51%
6	37	101	63%
4	57	162	65%
2	85	252	66%
1/0	129	393	67%

Wire Electrical Properties				
AWG	TurboFlex® Aluminum		TurboFlex® Copper	
	DC Resistance, Ohm/1000 ft	Max Current, Amps*	DC Resistance, Ohm/1000 ft	Max Current, Amps
16	6.85	27	4.55	36
14	4.26	36	2.85	54
12	2.80	47	1.85	68
10	1.69	63	1.16	90
8	1.07	83	0.72	124
6	0.67	112	0.46	165
4	0.42	148	0.30	220
2	0.26	197	0.19	293
1/0	0.16	262	0.12	399

Maximum ampacities are based on temperature rise to limits of the materials used in cable construction, based on single cable bundle in free air and at sea level pressure. Consult Glenair for more information.

Conductor Temperature Increase Above Ambient			
Applied Current, Amps DC	TurboFlex™ Aluminum, 8 AWG	TurboFlex™ Copper, 8 AWG	
50	31°C	21°C	
100	124°C	75°C	
125	198°C	113°C	

Maximum ampacities are based on temperature rise to limits of the materials used in cable construction, based on single cable bundle in free air and at sea level pressure. Consult Glenair for more information.

Durability Testing of Crimped Contacts on 8 AWG Wire			
Crimp Resistance, Un-aged	TurboFlex™ Aluminum	TurboFlex™ Copper	Requirement
Initial Crimp Resistance at 40 Amps, mΩ	0.047	0.022	3.0 max
After Thermal Cycling, -65°C to 175°C, 500 cycles			
Crimp Tensile Strength after cycling, lbf	261	402	232 min
Crimp Resistance at 40 Amps, mΩ	0.153	0.029	3.0 max
After 1000 hours at 175°C			
Crimp Tensile Strength, lbf	253	388	232 min
Crimp Resistance at 40 Amps, mΩ	0.090	0.033	3.0 max
After 1500 thermal cycles, Ambient to 175°C while energized with 40 Amps DC			
Crimp Tensile Strength, lbf	260	387	232 min
Crimp Resistance at 40 Amps, mΩ	0.164	0.030	3.0 max
After 500 Hours Dynamic Salt Fog in a PowerTrip™ Connector			
Crimp Tensile Strength, lbf	240	410	232 min
Crimp Resistance at 40 Amps, mΩ	0.074	0.030	3.0 max
After Vibration & Shock* in a PowerTrip™ Connector			
Crimp Tensile Strength, lbf	244	421	232 min
Crimp Resistance at 40 Amps, mΩ	0.065	0.025	3.0 max

Test performed using standard PowerTrip gold plated copper contacts (P/N 850-026-8-8-2), crimped without special bushings or processes.

*16 Hours random vibration per EIA-364-28F, Condition VI, Letter J (43.92 Grms) and 6 shocks of 300G

Duraelectric™ D performance specifications

PERFORMANCE / MATERIAL SPECIFICATIONS

Duraelectric™ D is a high-performance elastomeric material for use as wire insulation, cable jacketing, conduit jacketing, cable/conduit overmolding, and Autoshrink™ tubing and boots.

NOTABLE ATTRIBUTES

- **Service Temperature Range: -65°C to 200°C**
- **Fire Resistant and Low Smoke-Zero Halogen (LSZH), PFAS-free**
- **Resistant to common aerospace, military and industrial fluids**
- **NASA MAPTIS Registered, material code 09717**

Duraelectric™ D - Physical Properties		
Property	Typical Result	Test Method
Hardness, Shore A	60	ASTM D2240
Tensile Strength, psi	1100	ASTM D412
Elongation, %	500	ASTM D412
Tear Strength, Die B, ppi	150	ASTM D624
Low Temperature Impact at -65°C	Pass/No Cracks	ASTM D2137
Accelerated UV/Sunlight Resistance, 53 Year Equivalent Exposure	Pass/Excellent	IEC 60068-2-5
Ozone Resistance	Pass/No Cracks	ASTM D1149
Zero Halogen	Pass	IEC 60754-1

Duraelectric™ D - Electrical Properties		
Property	Typical Result	Test Method
Dielectric Strength, kV/mm	19	ASTM D149
Comparative Tracking Index, VAC	> 600	ASTM D3638

Duraelectric™ D - Fire Resistance Properties	
Property	Typical Result
Flammability	
Oxygen Index, %	45
FAR 25.853, 12 Second Vertical	Pass
FAR 25.853, 60 Degree	Pass
FAR 27.1365 b,c	Pass
BSS7230 Method F2	Pass
IEC60614-1	Pass
EN60695-2-12, 850°C Glow-Wire	Pass
UL1685 FT4/IEEE1202	Pass
Smoke Density	
BSS7238	Pass
NES 711	Pass
EN 60695-2-11	Pass
UL1685 FT4/IEEE1202	Pass
Combustion Toxicity	
BSS7239	Pass
NES 713	Pass
SMP800 C	Pass

IMPORTANT NOTE

Data are generated in accordance with prevailing national and international test standards and should be used only for material comparison. Actual property values are highly dependent on part geometry, mold configuration, and processing conditions. Please contact the factory to discuss the use of Duraelectric™ D in specific applications or environments.

Duralectric™ L performance specifications

Duralectric™ L (light) is a high-performance elastomeric material for use as lightweight wire insulation, cable jacketing, conduit jacketing, and cable/conduit overmolding.

NOTABLE ATTRIBUTES

- Service Temperature Range: -65°C to 200°C
- Fire Resistant and Low Smoke-Zero Halogen (LSZH), PFAS-free
- Excellent abrasion resistance
- 30% lighter than original Duralectric™
- 50% lighter than Teflon

Duralectric™ L - Physical Properties		
Property	Typical Result	Test Method
Hardness, Shore A	60	ASTM D2240
Tensile Strength, psi	850	ASTM D412
Elongation, %	300	ASTM D412
Tear Strength, Die B, ppi	125	ASTM D624
Low Temperature Impact at -65°C	Pass/No Cracks	ASTM D2137
Ozone Resistance	Pass/No Cracks	ASTM D518
Zero Halogen	Pass	IEC 754-1
Density, g/cm ³	0.96	ASTM D297
Taber Abrasion, 1500 cycles, weight loss mg/cycle	<.005	ASTM D3389

Duralectric™ L - Electrical Properties		
Property	Typical Result	Test Method
Dielectric Strength, kV/mm	16	ASTM D419
Insulation resistance, GOhm	> 100	ASTM D257
Dielectric constant	2.47	ASTM D150

Duralectric™ L - Fire Resistance Properties	
Property	Typical Result
Flammability	
Oxygen Index, %	36
FAR 25.853, 60 Second Vertical	Pass
BSS7230 Method F6	Pass
Smoke Density	
BSS7238	Pass
Combustion Toxicity	
BSS7239	Pass
SMP800 C	Pass

IMPORTANT NOTE

Data are generated in accordance with prevailing national and international test standards and should be used only for material comparison. Actual property values are highly dependent on part geometry, mold configuration, and processing conditions. Please contact the factory to discuss the use of Duralectric™ L in specific applications or environments.

Duralectric™ K performance specifications

PERFORMANCE / MATERIAL SPECIFICATIONS

Duralectric™ K is a high-performance elastomeric material for use as wire insulation, cable jacketing, conduit jacketing, and cable/conduit overmolding.

NOTABLE ATTRIBUTES

- **Service Temperature Range: -110°C to 200°C**
- **Fire Resistant and Low Smoke-Zero Halogen (LSZH)**
- **Resistant to common aerospace, military and industrial fluids**
- **Resistant to gamma radiation**

Duralectric™ K Physical Properties		
Property	Typical Result	Test Method
Hardness, Shore A	55	ASTM D2240
Tensile Strength, psi	1000	ASTM D412
Elongation, %	500	ASTM D412
Tear Strength, Die B, ppi	225	ASTM D624
Low Temperature Impact at -110°C	Pass/No Cracks	ASTM D2137
Ozone Resistance	Pass/No Cracks	ASTM D518
Zero Halogen	Pass	IEC 754-1
Gamma Radiation Resistance, Max Total Lifetime Dose, MRad	100	ASTM D412

Duralectric™ K Electrical Properties		
Property	Typical Result	Test Method
Dielectric Strength, kV/mm	15	ASTM D419

Duralectric™ K Fluid Resistance MIL-STD-810G, Method 504, Procedure II	
A-A-52624A Type I and Type II	MIL-L-23699 Gas Turbine Engine Oil
Amerex AFFF Fire Extinguishing Foam	MIBK
AMS 1432 Potassium Acetate De-Icer	Propylene Glycol Antifreeze
Calla 855 Aircraft Cleaner	R-134 Refrigerant
Coolanol 25R Silicate Ester Fluid	Royco 500 Gas Turbine Engine Oil
E36 Runway De-Icer	Royco 756 Hydraulic Fluid
Isopropyl Alcohol	MIL-H-5606 Hydraulic Fluid
JP-8	TT-I-735
MIL-C-85570 Aircraft Cleaner	Boiling Water
MIL-C-87252 Coolant	
Duralectric™ K is not recommended for continuous immersion in petroleum based fuels, solvents, crude oil, or Type V phosphate ester fluids.	

IMPORTANT NOTE

Data are generated in accordance with prevailing national and international test standards and should be used only for material comparison. Actual property values are highly dependent on part geometry, mold configuration, and processing conditions. Please contact the factory to discuss the use of Duralectric™ K in specific applications or environments.

Duraelectric™ F performance specifications

Duraelectric™ F is a high-performance elastomeric material for use as cable jacketing, conduit jacketing, cable/conduit overmolding, and Autoshrink™ tubing and boots

NOTABLE ATTRIBUTES

- **Service Temperature Range: -65°C to 200°C**
- **Fire Resistant and suitable for immersion in jet fuel, diesel, lubricants, and solvents**

Duraelectric™ F Physical Properties		
Property	Typical Result	Test Method
Hardness, Shore A	55	ASTM D2240
Tensile Strength, psi	1200	ASTM D412
Elongation, %	400	ASTM D412
Tear Strength, Die B, ppi	200	ASTM D624
Low Temperature Impact at -65°C	Pass/No Cracks	ASTM D2137
Ozone Resistance	Pass/No Cracks	ASTM D518

Duraelectric™ F Electrical Properties		
Property	Typical Result	Test Method
Dielectric Strength, kV/mm	14	ASTM D149

Duraelectric™ F Fluid Resistance ASTM D471 Immersion		
A-A-52624A Type I and Type II	2-Ethylhexyl Sebacate	MIL-L-23699 Gas Turbine Engine Oil
Amerex AFFF Fire Extinguishing Foam	Isooctane	Plexol 201
AMS 1432 Potassium Acetate De-Icer	70/30 Isooctane / Toluene	Polyol Esters
AMS 2629	Isopropyl Alcohol	Propylene Glycol Antifreeze
AMS3021	Jet A	Royco 500 Gas Turbine Engine Oil
Boiling Water	JET Oil	Royco 756 Hydraulic Fluid
Calla 855 Aircraft Cleaner	JP-8	TT-I-735
Coolanol 25R Silicate Ester Fluid	MIL-C-85570 Aircraft Cleaner	TTS-735 TY I & III
Diesel #2	MIL-C-87252 Coolant	
E36 Runway De-Icer	MIL-H-5606 Hydraulic Fluid	
Duraelectric™ F is not recommended for continuous immersion in phosphate ester fluids such as Skydrol or HyJet.		

IMPORTANT NOTE

Data are generated in accordance with prevailing national and international test standards and should be used only for material comparison. Actual property values are highly dependent on part geometry, mold configuration, and processing conditions. Please contact the factory to discuss the use of Duraelectric™ F in specific applications or environments.

Duralectric™ C performance specifications

PERFORMANCE / MATERIAL SPECIFICATIONS

Duralectric™ C is an electrically conductive elastomeric material used to control the electric field in high-voltage cable applications.

NOTABLE ATTRIBUTES

- Electrically conductive
- High bond strength in multi-layer insulated cables

Duralectric™ C Physical Properties		
Property	Typical Result	Test Method
Hardness, points, Shore A	65 ± 5	ASTM D 2240
Tensile Strength, psi, minimum	400	ASTM D 412
Ultimate Elongation, %, minimum	150	ASTM D 412
Tear Strength, Die B, ppi	50	ASTM D 624
Volume Resistivity, Ω-cm	10 max	ASTM D 257

IMPORTANT NOTE

Data are generated in accordance with prevailing national and international test standards and should be used only for material comparison. Actual property values are highly dependent on part geometry, mold configuration, and processing conditions. Please contact the factory to discuss the use of Duralectric™ C in specific applications or environments.

TurboFlex® Copper Core, Duraelectric™ D Insulation, 4500 VAC 961-001 Imperial

FEATURES

- .125" Duraelectric D insulation for 4500 VAC, 6300 VDC rating
- Service temperature range -65° to +200°C (consult factory for excursions beyond +200°C)

How to Order TurboFlex®					
Sample Part Number	961	-001	-T	-G	-2
Basic No.	TurboFlex with Duraelectric D Insulation				
Wall Thickness	-001 = .125"				
Conductor Material	-T = Tin/Copper (-65 – 150°C) -S = Silver/Copper (-65 – 200°C) -N = Nickel/Copper (-65 – 200°C)				
Wire Size (See Table I)	G, H, I, J, K, M, L				
Duraelectric D Insulation Color	See Table II				

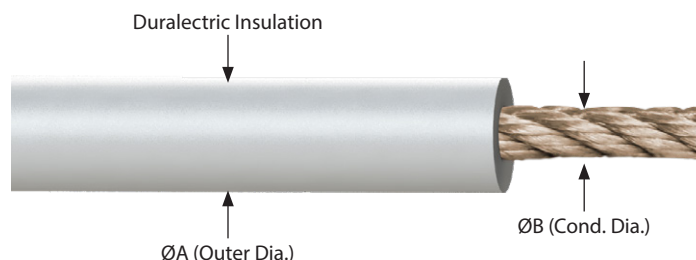

Table I: TurboFlex Wire Size, Dimensions, DC Resistance and Ampacity Ratings

AWG Code	AWG	Strand / Count / AWG	Cir Mil (nom)	Ø B in. (mm)	DC Resistance @ 20°C (Ohms / 1000 ft.)			Typical Ampacity (Amps) 40°C Ambient	
					Nickel Copper	Tin Copper	Silver Copper	Nickel / Silver Copper	Tin Copper
G	1/0	7 X 7 X 86/36	105350	.431 (10.95)	.1178	.1188	.1107	195–465	195–395
H	2/0	7 X 7 X 108/36	132300	.483 (12.27)	.0938	.0946	.0882	225–540	225–460
I	3/0	19 X 7 X 51/36	169575	.547 (13.89)	.0738	.0745	.0694	260–640	260–540
J	4/0	19 X 7 X 64/36	212800	.613 (15.57)	.0588	.0594	.0553	310–755	310–640
K	250 MCM	19 X 7 X 75/36	249375	.663 (16.84)	.0502	.0507	.0472	315–760	315–645
M	350 MCM	19 X 7 X 106/36	352450	.789 (20.04)	.0355	.0359	.0320	380–910	380–775
L	450 MCM	19 X 7 X 135/36	448875	.890 (22.61)	.0279	.0282	.0262	440–1040	440–890

Maximum ampacities are based on temperature rise to limits of the materials used in cable construction, based on single cable bundle in free air and at sea level pressure. Consult Glenair for more information.

Table II: Duraelectric D Insulation Color

Weatherproof, halogen free, flame resistant	
0	Black
1	Brown
2	Red
3	Orange
4	Yellow
5	Kelly Green
6	Blue
7	Violet
8	Gray
9	White

Consult factory for other specific colors

Wire Weight and Outer Diameter

AWG Code	Weight lbs/1000 ft. (nom.)	Ø A in. (mm)	Insulation wall thickness in. (mm)
G	494.50	.681 (17.30)	.125 (3.18)
H	600.00	.733 (18.62)	
I	749.50	.797 (20.24)	
J	916.00	.863 (21.92)	
K	1055.60	.913 (23.19)	
M	1445.60	1.039 (26.39)	
L	1806.20	1.140 (28.96)	

NOTES

1. Bend radius is 3X the outer diameter
2. Cable will be marked with "GLENAIR TURBOFLEX", wire gauge, part number, CAGE 06324.
3. Insulation thickness tolerance is ±10%

TurboFlex® Copper Core, Duraelectric™ D Insulation, 4500 VAC 961-011 Metric

GENERAL-DUTY • COPPER CORE

FEATURES

- 3.18mm Duraelectric D insulation for 4500 VAC, 6300 VDC rating
- Service temperature range -65° to +200°C (consult factory for excursions beyond +200°C)

How to Order TurboFlex®					
Sample Part Number	961	-011	-C	-G	-2
Basic No.	TurboFlex with Duraelectric D Insulation				
Wall Thickness	-011 = 3.18mm				
Conductor Material	-T = Tin/Copper (-65 – 150°C) -S = Silver/Copper (-65 – 200°C) -N = Nickel/Copper (-65 – 200°C)				
Wire Size (See Table I)	G, H, I, J, K, L, M, N, P				
Duraelectric D Insulation Color	See Table II				

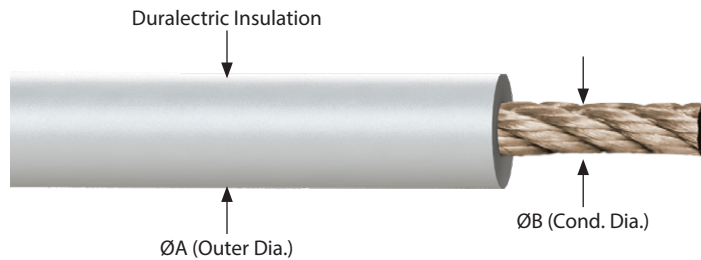

Table I: TurboFlex Wire Size, Dimensions, DC Resistance and Ampacity Ratings

AWG Code	mm ²	Strand / Count / AWG*	Ø B mm	DC Resistance @ 20°C (Ohms / 1000m)			Ampacity (Amps) 40°C Ambient	
				Nickel Copper	Tin Copper	Silver Copper	Nickel Copper	Tin/Silver Copper
G	50	7 X 7 X 86/36	10.95	.3864	.3897	.3631	532	399
H	70	19 X 7 X 42/36	12.60	.2942	.2968	.2765	---	---
I	95	19 X 7 X 51/36	13.90	.2421	.2444	.2276	708	546
J	120	19 X 7 X 75/36	16.84	.1647	.1663	.1548	910	705
K	150	19 X 7 X 91/36	18.57	.1358	.1371	.1276	---	---
L	185	19 X 7 X 106/36	20.04	.1164	.1178	.1096	1140	880
M	240	19 X 7 X 135/36	22.61	.0915	.0925	.0859	1320	1020
N	300	19 X 7 X 45/30	26.11	.0659	.0666	.0620	1580	1225
P	500	19 X 7 X 75/30	33.71	.0397	.0400	.0371	---	---

*Metric equivalent to 36AWG is 0.0127mm²

Maximum ampacities are based on temperature rise to limits of the materials used in cable construction, based on single cable bundle in free air and at sea level pressure. Consult Glenair for more information.

Table II: Duraelectric D Insulation Color

Weatherproof, halogen free, flame resistant	
0	Black
1	Brown
2	Red
3	Orange
4	Yellow
5	Kelly Green
6	Blue
7	Violet
8	Gray
9	White

Consult factory for other specific colors

Wire Weight and Outer Diameter

AWG Code	Weight Kg/1000m (nom)	Ø A mm	Insulation wall thickness mm
G	735.90	17.31	3.18
H	942.00	18.96	
I	1115.40	20.26	
J	1570.90	23.20	
K	1871.30	24.93	
L	2159.10	26.40	
M	2687.90	28.97	
N	3514.40	32.47	
P	5694.40	40.07	

NOTES

1. Bend radius is 3X the outer diameter
2. Cable will be marked with "GLENAIR TURBOFLEX", wire gauge, part number, CAGE 06324.
3. Insulation thickness tolerance is ±10%

TurboFlex® Copper Core, Duraelectric™ D Insulation, 3500 VAC 961-002 Imperial

FEATURES

- .093" Duraelectric D insulation for 3500 VAC, 4900 VDC rating
- Service temperature range -65° to +200°C (consult factory for excursions beyond +200°C)

How to Order TurboFlex®					
Sample Part Number	961	-002	-T	-G	-2
Basic No.	TurboFlex with Duraelectric D Insulation				
Wall Thickness	-002 = .093"				
Conductor Material	-T = Tin/Copper (-65 – 150°C) -S = Silver/Copper (-65 – 200°C) -N = Nickel/Copper (-65 – 200°C)				
Wire Size (See Table I)	C, D, E, F, G, H, I, J, K, M, L				
Duraelectric D Insulation Color	See Table II				

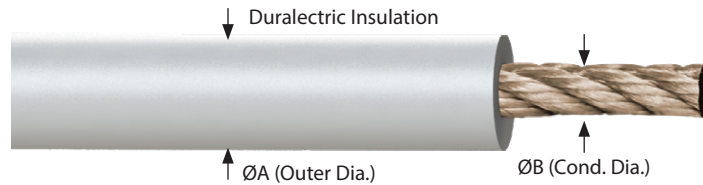

Table I: TurboFlex Wire Size, Dimensions, DC Resistance and Ampacity Ratings

AWG Code	AWG	Strand / Count / AWG	Cir Mil (nom)	Ø B in. (mm)	DC Resistance @ 20°C (Ohms / 1000 ft.)			Typical Ampacity (Amps) 40°C Ambient	
					Nickel Copper	Tin Copper	Silver Copper	Nickel/Silver Copper	Tin Copper
R	16	7 X 15/36	2625	.063 (1.60)	4.5510	4.5930	4.2780	15-35	15-30
S	14	7 X 24/36	4200	.080 (2.03)	2.8450	2.8710	2.6740	20-50	20-45
A	12	7 X 37/36	6475	.099 (2.51)	1.8450	1.8620	1.7340	30-70	30-60
B	10	7 X 59/36	10325	.126 (3.20)	1.1570	1.1680	1.0880	40-90	40-75
C	8	7 X 95/36	16625	.159 (4.04)	.7188	.7252	.6755	55-135	55-115
D	6	7 X 150/36	26250	.200 (5.08)	.4551	.4593	.4278	75-185	75-155
E	4	7 X 7 X 34/36	41650	.271 (6.88)	.2979	.3006	.2800	105-250	105-215
F	2	7 X 7 X 54/36	66150	.342 (8.69)	.1876	.1893	.1763	145-345	145-290
G	1/0	7 X 7 X 86/36	105350	.431 (10.95)	.1178	.1188	.1107	195-465	195-395
H	2/0	7 X 7 X 108/36	132300	.483 (12.27)	.0938	.0946	.0882	225-540	225-460
I	3/0	19 X 7 X 51/36	169575	.547 (13.89)	.0738	.0745	.0694	260-640	260-540
J	4/0	19 X 7 X 64/36	212800	.613 (15.57)	.0588	.0594	.0553	310-755	310-640
K	250 MCM	19 X 7 X 75/36	249375	.663 (16.84)	.0502	.0507	.0472	315-760	315-645
M	350 MCM	19 X 7 X 106/36	352450	.789 (20.04)	.0355	.0359	.0320	380-910	380-775
L	450 MCM	19 X 7 X 135/36	448875	.890 (22.61)	.0279	.0282	.0262	440-1040	440-890

Maximum ampacities are based on temperature rise to limits of the materials used in cable construction, based on single cable bundle in free air and at sea level pressure. Consult Glenair for more information.

Table II: Duraelectric D Insulation Color

Weatherproof, halogen free, flame resistant	
0	Black
1	Brown
2	Red
3	Orange
4	Yellow
5	Kelly Green
6	Blue
7	Violet
8	Gray
9	White

Consult factory for other specific colors

Wire Weight and Outer Diameter

AWG Code	Weight lbs/1000 ft. (nom.)	Ø A in. (mm)	Insulation wall thickness in. (mm)
C	99.10	.345 (8.76)	.093 (2.36)
D	138.40	.386 (9.80)	
E	207.40	.457 (11.61)	
F	304.60	.528 (13.41)	
G	455.80	.617 (15.67)	
H	558.20	.669 (16.99)	
I	703.90	.733 (18.62)	
J	866.50	.799 (20.29)	
K	1003.10	.849 (21.56)	
M	1385.50	.975 (24.76)	
L	1740.10	1.076 (27.33)	

NOTES

1. Bend radius is 3X the outer diameter
2. Cable will be marked with "GLENAIR TURBOFLEX", wire gauge, part number, CAGE 06324.
3. Insulation thickness tolerance is ±10%

TurboFlex® Copper Core, Duraelectric™ D Insulation, 3500 VAC 961-012 Metric

GENERAL-DUTY • COPPER CORE

FEATURES

- 2.36mm Duraelectric D insulation for 3500 VAC, 4900 VDC rating
- Service temperature range -65° to +200°C (consult factory for excursions beyond +200°C)

How to Order TurboFlex®					
Sample Part Number	961	-012	-T	-G	-2
Basic No.	TurboFlex with Duraelectric D Insulation				
Wall Thickness	-012 = 2.36mm				
Conductor Material	-T = Tin/Copper (-65 – 150°C) -S = Silver/Copper (-65 – 200°C) -N = Nickel/Copper (-65 – 200°C)				
Wire Size (See Table I)	C, D, E, F, G, H, I, J, K, L, M, N				
Duraelectric D Insulation Color	See Table II				

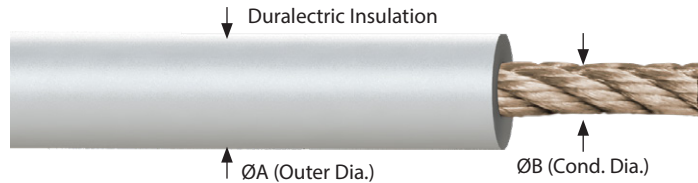

AWG Code	mm ²	Strand / Count / AWG	Ø B mm	DC Resistance @ 20°C (Ohms / 1000 m)			Ampacity (Amps) 40°C Ambient	
				Nickel Copper	Tin Copper	Silver Copper	Nickel Copper	Tin/Silver Copper
C	10	7 X 95/36	4.04	2.3577	2.3787	2.2156	142	124
D	16	7 X 150/36	5.08	1.4927	1.5065	1.4032	205	165
E	25	7 X 7 X 34/36	6.88	.9771	.9860	.9184	278	220
F	35	7 X 7 X 54/36	8.69	.6153	.6209	.5783	381	293
G	50	7 X 7 X 86/36	10.95	.3864	.3897	.3631	532	399
H	70	19 X 7 X 42/36	12.60	.2942	.2968	.2765	-----	-----
I	95	19 X 7 X 51/36	13.90	.2421	.2444	.2276	708	546
J	120	19 X 7 X 75/36	16.84	.1647	.1663	.1548	910	705
K	150	19 X 7 X 91/36	18.557	.1358	.1371	.1276	-----	-----
L	185	19 X 7 X 106/36	20.04	.1164	.1178	.1096	1140	880
M	240	19 X 7 X 135/36	22.61	.0915	.0925	.0859	1320	1020
N	300	19 X 7 X 45/30	26.11	.0659	.0666	.062	-----	-----

*Metric equivalent to 36AWG is 0.0127mm²

Maximum ampacities are based on temperature rise to limits of the materials used in cable construction, based on single cable bundle in free air and at sea level pressure. Consult Glenair for more information.

Weatherproof, halogen free, flame resistant	
0	Black
1	Brown
2	Red
3	Orange
4	Yellow
5	Kelly Green
6	Blue
7	Violet
8	Gray
9	White

Consult factory for other specific colors

AWG Code	Weight Kg/1000m (nom.)	Ø A mm	Insulation wall thickness mm
C	147.50	8.76	2.36
D	206.00	9.80	
E	308.60	11.61	
F	453.30	13.41	
G	678.30	15.67	
H	878.60	16.84	
I	1047.50	18.62	
J	1492.80	21.56	
K	1787.10	23.29	
L	2069.80	24.76	
M	2589.50	27.33	
N	3403.90	30.83	

NOTES

1. Bend radius is 3X the outer diameter
2. Cable will be marked with "GLENAIR TURBOFLEX", wire gauge, part number, CAGE 06324.
3. Insulation thickness tolerance is ±10%

TurboFlex® Copper Core, Duraelectric™ D Insulation, 3000 VAC 961-003 Imperial

FEATURES

- .062" Duraelectric D insulation for 3000 VAC, 4200 VDC rating
- Service temperature range -65° to +200°C (consult factory for excursions beyond +200°C)

How to Order TurboFlex®					
Sample Part Number	961	-003	-T	-G	-2
Basic No.	TurboFlex with Duraelectric D Insulation				
Wall Thickness	-003 = .062"				
Conductor Material	-T = Tin/Copper (-65 – 150°C) -S = Silver/Copper (-65 – 200°C) -N = Nickel/Copper (-65 – 200°C)				
Wire Size (See Table I)	A, B, C, D, E, F, G, H				
Duraelectric D Insulation Color	See Table II				

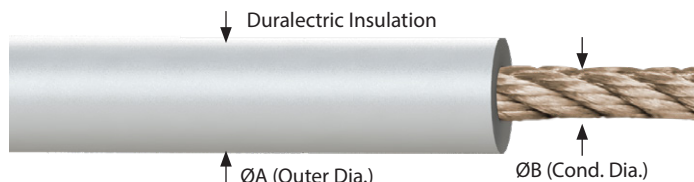

Table I: TurboFlex Wire Size, Dimensions, DC Resistance and Ampacity Ratings

AWG Code	AWG	Strand / Count / AWG	Cir Mil (nom)	Ø B in. (mm)	DC Resistance @ 20°C (Ohms / 1000 ft.)			Typical Ampacity (Amps) 40°C Ambient	
					Nickel Copper	Tin Copper	Silver Copper	Nickel / Silver Copper	Tin Copper
R	16	7 X 15/36	2625	.063 (1.60)	4.5510	4.5930	4.2780	15-35	15-30
S	14	7 X 24/36	4200	.080 (2.03)	2.8450	2.8710	2.6740	20-50	20-45
A	12	7 X 37/36	6475	.099 (2.51)	1.8450	1.8620	1.7340	30-70	30-60
B	10	7 X 59/36	10325	.126 (3.20)	1.1570	1.1680	1.0880	40-90	40-75
C	8	7 X 95/36	16625	.159 (4.04)	.7188	.7252	.6755	55-135	55-115
D	6	7 X 150/36	26250	.200 (5.08)	.4551	.4593	.4278	75-185	75-155
E	4	7 X 7 X 34/36	41650	.271 (6.88)	.2979	.3006	.2800	105-250	105-215
F	2	7 X 7 X 54/36	66150	.342 (8.69)	.1876	.1893	.1763	145-345	145-290
G	1/0	7 X 7 X 86/36	105350	.431 (10.95)	.1178	.1188	.1107	195-465	195-395
H	2/0	7 X 7 X 108/36	132300	.483 (12.27)	.0938	.0946	.0882	225-540	225-460
I	3/0	19 X 7 X 51/36	169575	.547 (13.89)	.0738	.0745	.0694	260-640	260-540
J	4/0	19 X 7 X 64/36	212800	.613 (15.57)	.0588	.0594	.0553	310-755	310-640

Maximum ampacities are based on temperature rise to limits of the materials used in cable construction, based on single cable bundle in free air and at sea level pressure. Consult Glenair for more information.

Table II: Duraelectric D Insulation Color

Weatherproof, halogen free, flame resistant	
0	Black
1	Brown
2	Red
3	Orange
4	Yellow
5	Kelly Green
6	Blue
7	Violet
8	Gray
9	White

Consult factory for other specific colors

Wire Weight and Outer Diameter			
AWG Code	Weight lbs/1000 ft. (nom.)	Ø A in. (mm)	Insulation wall thickness in. (mm)
R	23.20	.187 (4.75)	.062 (1.57)
S	30.40	.204 (5.18)	
A	40.20	.223 (5.66)	
B	56.20	.250 (6.35)	
C	81.00	.283 (7.19)	
D	117.90	.324 (8.23)	
E	182.80	.395 (10.03)	
F	275.90	.466 (11.84)	
G	422.00	.555 (14.10)	
H	521.40	.607 (15.42)	
I	663.40	.671 (17.04)	
J	822.20	.737 (18.72)	

NOTES

1. Bend radius is 3X the outer diameter
2. Cable will be marked with "GLENAIR TURBOFLEX", wire gauge, part number, CAGE 06324.
3. Insulation thickness tolerance is ±10%

TurboFlex® Copper Core, Duraelectric™ D Insulation, 3000 VAC 961-006 Metric

GENERAL-DUTY • COPPER CORE

FEATURES

- 1.57 mm Duraelectric D insulation for 3500 VAC, 4900 VDC rating
- Service temperature range -65° to +200°C (consult factory for excursions beyond +200°C)

How to Order TurboFlex®					
Sample Part Number	961	-006	-T	-G	-2
Basic No.	TurboFlex with Duraelectric D Insulation				
Wall Thickness	-006 = 1.57mm				
Conductor Material	-T = Tin/Copper (-65 – 150°C) -S = Silver/Copper (-65 – 200°C) -N = Nickel/Copper (-65 – 200°C)				
Wire Size (See Table I)	A, B, C, D, E, F, G, H				
Duraelectric D Insulation Color	See Table II				

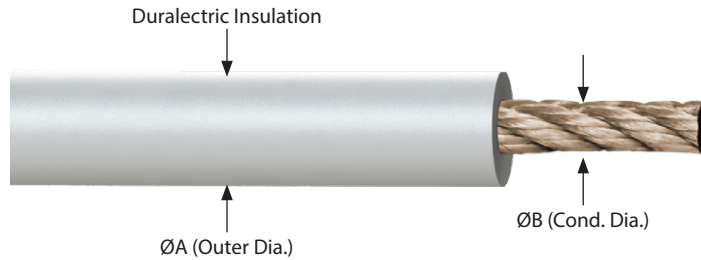

AWG Code	mm ²	Strand / Count / AWG	Ø B mm	DC Resistance @ 20°C (Ohms / 1000m)			Ampacity (Amps) 40°C Ambient	
				Nickel Copper	Tin Copper	Silver Copper	Nickel Copper	Tin/Silver Copper
A	4	7 X 37/36	2.52	6.0516	6.1074	5.6875	78	68
B	6	7 X 59/36	3.20	3.7950	3.8310	3.5686	107	90
C	10	7 X 95/36	4.04	2.377	2.3787	2.2156	142	124
D	16	7 X 150/36	5.08	1.4927	1.5065	1.4032	205	165
E	25	7 X 7 X 34/36	6.88	.9771	.9860	.9184	278	220
F	35	7 X 7 X 54/36	8.69	.6153	.6209	.5783	381	293
G	50	7 X 7 X 86/36	10.95	.3864	.3897	.3631	532	399
H	70	7 X 7 X 108/36	12.60	.2942	.2968	.2765	----	----

*Metric equivalent to 36AWG is 0.0127mm²

Maximum ampacities are based on temperature rise to limits of the materials used in cable construction, based on single cable bundle in free air and at sea level pressure. Consult Glenair for more information.

Table II: Duraelectric D Insulation Color

Weatherproof, halogen free, flame resistant	
0	Black
1	Brown
2	Red
3	Orange
4	Yellow
5	Kelly Green
6	Blue
7	Violet
8	Gray
9	White

Consult factory for other specific colors

AWG Code	Weight Kg/1000m (nom.)	Ø A mm	Insulation wall thickness mm
A	59.80	5.66	1.57
B	83.60	6.34	
C	120.50	7.18	
D	175.50	8.22	
E	272.00	10.02	
F	410.60	11.83	
G	628.00	14.09	
H	822.70	15.74	

NOTES

1. Bend radius is 3X the outer diameter
2. Cable will be marked with "GLENAIR TURBOFLEX", wire gauge, part number, CAGE 06324.
3. Insulation thickness tolerance is ±10%

TurboFlex® Copper Core, Duraelectric™ D Insulation, 2000 VAC 961-004 Imperial

FEATURES

- .032" Duraelectric D insulation for 2000 VAC, 2800 VDC rating

How to Order TurboFlex®					
Sample Part Number	961	-004	-T	-G	-2
Basic No.	TurboFlex with Duraelectric D Insulation				
Wall Thickness	-004 = .032"				
Conductor Material	-T = Tin/Copper (-65 – 150°C) -S = Silver/Copper (-65 – 200°C) -N = Nickel/Copper (-65 – 200°C)				
Wire Size (See Table I)	T, R, S, A, B, C, D, E, F, G				
Duraelectric D Insulation Color	See Table II				

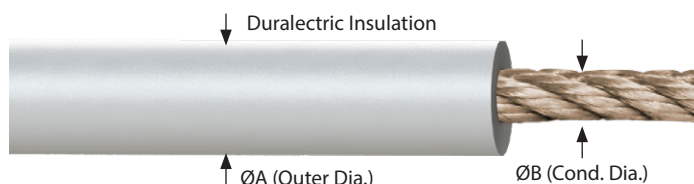

Table I: TurboFlex Wire Size, Dimensions, DC Resistance and Ampacity Ratings

AWG Code	AWG	Strand / Count / AWG	Cir Mil (nom)	Ø B in. (mm)	DC Resistance @ 20°C (Ohms / 1000 ft.)			Typical Ampacity (Amps) 40°C Ambient	
					Nickel Copper	Tin Copper	Silver Copper	Nickel/Silver Copper	Tin Copper
T	20	42-36	1050	.037 (.94)	10.7178	10.7538	10.0747	10–25	10–20
R	16	7 X 15/36	2625	.063 (1.60)	4.5510	4.5930	4.2780	15–35	15–30
S	14	7 X 24/36	4200	.080 (2.03)	2.8450	2.8710	2.6740	20–50	20–45
A	12	7 X 37/36	6475	.099 (2.51)	1.8450	1.8620	1.7340	30–70	30–60
B	10	7 X 59/36	10325	.126 (3.20)	1.1570	1.1680	1.0880	40–90	40–75
C	8	7 X 95/36	16625	.159 (4.04)	.7188	.7252	.6755	55–135	55–115
D	6	7 X 150/36	26250	.200 (5.08)	.4551	.4593	.4278	75–185	75–155
E	4	7 X 7 X 34/36	41650	.271 (6.88)	.2979	.3006	.2800	105–250	105–215
F	2	7 X 7 X 54/36	66150	.342 (8.69)	.1876	.1893	.1763	145–345	145–290
G	1/0	7 X 7 X 86/36	105350	.431 (10.95)	.1178	.1188	.1107	195–465	195–395

Maximum ampacities are based on temperature rise to limits of the materials used in cable construction, based on single cable bundle in free air and at sea level pressure. Consult Glenair for more information.

Table II: Duraelectric D Insulation Color

Weatherproof, halogen free, flame resistant	
0	Black
1	Brown
2	Red
3	Orange
4	Yellow
5	Kelly Green
6	Blue
7	Violet
8	Gray
9	White

Consult factory for other specific colors

Wire Weight and Outer Diameter

AWG Code	Weight lbs/1000 ft. (nom.)	Ø A in. (mm)	Insulation wall thickness in. (mm)
T	7.60	.101 (2.57)	.032 (.81)
R	14.40	.127 (3.23)	
S	20.70	.144 (3.66)	
A	29.40	.163 (4.14)	
B	43.90	.190 (4.83)	
C	66.90	.223 (5.66)	
D	101.40	.264 (6.71)	
E	162.40	.335 (8.51)	
F	251.60	.406 (10.31)	
G	392.70	.495 (12.57)	

NOTES

1. Bend radius is 3X the outer diameter
2. Cable will be marked with "GLENAIR TURBOFLEX", wire gauge, part number, CAGE 06324.
3. Insulation thickness tolerance is ±.005
4. NASA MAPTIS Registered, material code 09866

TurboFlex[®] Copper Core, Duraelectric[™] D Insulation, 2000 VAC 961-014 Metric

GENERAL-DUTY • COPPER CORE

FEATURES

- .81mm Duraelectric D insulation for 2000 VAC, 2800 VDC rating

How to Order TurboFlex [®]					
Sample Part Number	961	-014	-T	-G	-2
Basic No.	TurboFlex with Duraelectric D Insulation				
Wall Thickness	-014 = .81mm				
Conductor Material	-T = Tin/Copper (-65 – 150°C) -S = Silver/Copper (-65 – 200°C) -N = Nickel/Copper (-65 – 200°C)				
Wire Size (See Table I)	R, S, A, B, C, D, E, F, G				
Duraelectric D Insulation Color	See Table II				

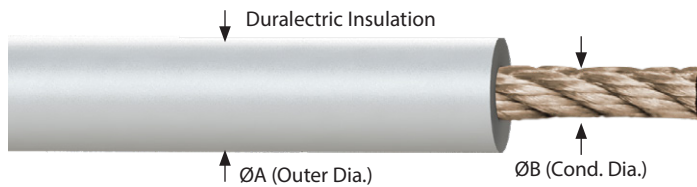

AWG Code	mm ²	Strand / Count / AWG	Ø B in. (mm)	DC Resistance @ 20°C (Ohms / 1000 ft.)			Ampacity (Amps) 40°C Ambient	
				Nickel Copper	Tin Copper	Silver Copper	Nickel Copper	Tin/Silver Copper
R	1.5	7 X 15/36	1.60	14.9273	15.0650	14.0318	40	36
S	2.5	7 X 24/36	2.03	9.3316	9.4169	8.7707	59	54
A	4	7 X 37/36	2.52	6.0516	6.1074	5.6875	78	68
B	6	7 X 59/36	3.20	3.7950	3.8310	3.5686	107	90
C	10	7 X 95/36	4.04	2.3577	2.3787	2.2156	142	124
D	16	7 X 150/36	5.08	1.4927	1.5065	1.4032	205	165
E	25	7 X 7 X 34/36	6.88	.9771	.9860	.9184	278	220
F	35	7 X 7 X 54/36	8.69	6.123	.6209	.5783	381	293
G	50	7 X 7 X 86/36	10.95	.3864	.3897	.3631	532	399

*Metric equivalent to 36AWG is 0.0127mm²

Maximum ampacities are based on temperature rise to limits of the materials used in cable construction, based on single cable bundle in free air and at sea level pressure. Consult Glenair for more information.

Weatherproof, halogen free, flame resistant	
0	Black
1	Brown
2	Red
3	Orange
4	Yellow
5	Kelly Green
6	Blue
7	Violet
8	Gray
9	White

Consult factory for other specific colors

AWG Code	Weight Kg /1000m (nom.)	Ø A mm	Insulation wall thickness mm
R	21.40	3.22	0.81mm
S	30.80	3.65	
A	43.80	4.14	
B	65.30	4.82	
C	99.60	5.66	
D	150.90	6.70	
E	241.70	8.50	
F	374.40	10.31	
G	584.40	12.57	

NOTES

1. Bend radius is 3X the outer diameter
2. Cable will be marked with "GLENAIR TURBOFLEX", wire gauge, part number, CAGE 06324.
3. Insulation thickness tolerance is ±.005

TurboFlex® M AS22759-type conductor, Duralectric™ D Insulation, 2000 VAC • 967-011 Imperial

FEATURES

- TurboFlex M, with AS22759 mil-spec type conductor provides flight heritage and the stiffness required in some installations, while .032" Duralectric D Insulation provides more flexibility than standard mil-spec wire. 2000 VAC, 2800 VDC-rated performance.

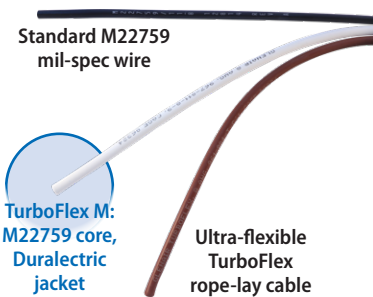

How to Order TurboFlex® M				
Sample Part Number	967-011	-8	-T	-1
Basic No.	TurboFlex M = AS22759 type conductor with Duralectric D Insulation			
Wire Size (See Table I)	16, 14, 12, 10, 8, 6, 4, 2, 1, 0			
Conductor Type	-T = Tin/Copper (-65 – 150°C) -S = Silver/Copper (-65 – 200°C) -N = Nickel/Copper (-65 – 200°C)			
Duralectric D Insulation Color	See Table II			

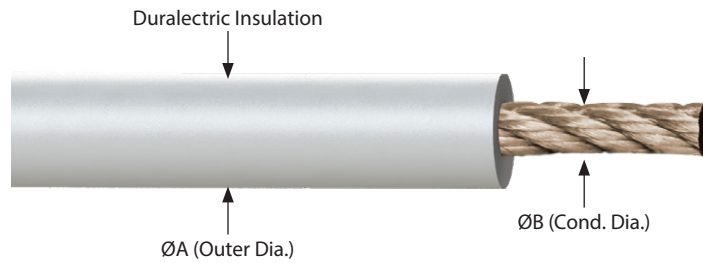

Wire Size AWG	No. Strands X AWG of Strands	Ø B in. (mm) nominal	Ø A in. (mm) nominal	Weight lbs/1000 ft. (nom.)	Insulation wall thickness in. (mm)
16	19 X 29	.053 (1.35)	.117 (2.97)	12.4	.032 (.81)
14	19 X 27	.066 (1.68)	.130 (3.30)	17.1	
12	37 X 28	.085 (2.16)	.149 (3.78)	25.0	
10	37 X 26	.107 (2.72)	.171 (4.34)	37.3	
8	133 X 29	.161 (4.09)	.225 (5.72)	65.5	
6	133 X 27	.209 (5.31)	.273 (6.93)	98.6	
4	133 X 25	.261 (6.63)	.325 (8.25)	151.7	
2	665 X 30	.333 (8.46)	.397 (10.08)	241.8	
1	817 X 30	.370 (9.40)	.434 (11.02)	304.0	
0	1045 X 30	.413 (10.49)	.477 (12.12)	365.5	

Maximum ampacities are based on temperature rise to limits of the materials used in cable construction, based on single cable bundle in free air and at sea level pressure. Consult Glenair for more information.

Weatherproof, halogen free, flame resistant	
0	Black
1	Brown
2	Red
3	Orange
4	Yellow
5	Kelly Green
6	Blue
7	Violet
8	Gray
9	White

Consult factory for other specific colors

NOTES

- Conductors per AS29606
- Cable will be marked with wire gauge, part number, CAGE 06324.
- Insulation thickness tolerance is ±.005
- Solid colors only, no striping available.

**TurboFlex® Copper Core, Duraelectric™ D Insulation, 1000 VAC
961-031 Imperial**

GENERAL-DUTY • COPPER CORE

FEATURES

- .016" Duraelectric D insulation for 1000 VAC rating

How to Order TurboFlex®					
Sample Part Number	961	-031	-T	-A	-2
Basic No.	TurboFlex with Duraelectric D Insulation				
Wall Thickness	-031 = .016"				
Conductor Material	-T = Tin/Copper (-65 – 150°C) -S = Silver/Copper (-65 – 200°C) -N = Nickel/Copper (-65 – 200°C)				
Wire Size (See Table I)	T, R, S, A, B, C				
Duraelectric D Insulation Color	See Table II				

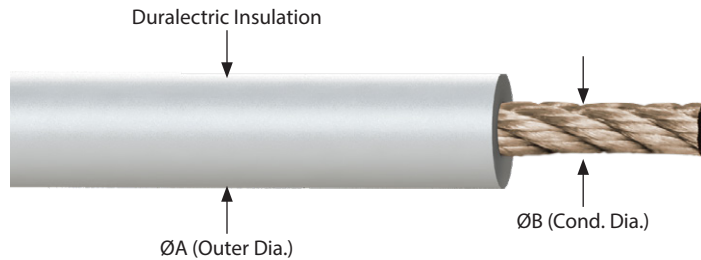

Table I: TurboFlex Wire Size, Dimensions, DC Resistance and Ampacity Ratings

AWG Code	AWG	Strand / Count / AWG	Cir Mil (nom)	Ø B in. (mm)	DC Resistance @ 20°C (Ohms / 1000 ft.)			Ampacity (Amps) 40°C Ambient	
					Nickel Copper	Tin Copper	Silver Copper	Nickel Copper	Tin/Silver Copper
T	20	42-36	1050	.037 (.94)	10.7178	10.7538	10.0747	16	14
R	16	7 X 15/36	2625	.063 (1.60)	4.5510	4.5930	4.2780	40	36
S	14	7 X 24/36	4200	.080 (2.03)	2.8450	2.8710	2.6740	59	54
A	12	7 X 37/36	6475	.099 (2.51)	1.8450	1.8620	1.7340	78	68
B	10	7 X 59/36	10325	.126 (3.20)	1.1570	1.1680	1.0880	107	90
C	8	7 X 95/36	16625	.159 (4.04)	.7188	.7252	.6755	142	124

Maximum ampacities are based on temperature rise to limits of the materials used in cable construction, based on single cable bundle in free air and at sea level pressure. Consult Glenair for more information.

Table II: Duraelectric D Insulation Color

Weatherproof, halogen free, flame resistant	
0	Black
1	Brown
2	Red
3	Orange
4	Yellow
5	Kelly Green
6	Blue
7	Violet
8	Gray
9	White

Consult factory for other specific colors

961-004 Wire Weight and Outer Diameter

AWG Code	Weight lbs/1000 ft. (nom.)	Ø A in. (mm)	Insulation wall thickness in. (mm)
T	5.00	.069 (1.75)	.016 (0.41)
R	11.10	.095 (2.41)	
S	16.90	.112 (2.84)	
A	25.00	.131 (3.33)	
B	38.70	.158 (4.01)	
C	60.70	.191 (4.85)	

NOTES

1. Bend radius is 3X the outer diameter
2. Cable will be marked with "GLENAIR TURBOFLEX", wire gauge, part number, CAGE 06324.
3. Insulation thickness tolerance is ±.002
4. NASA MAPTIS Registered, material code 09866

TurboFlex® Copper Core, Dual-layer Duraelectric™ D Insulation/Jacket, 3000 VAC • 961-035 Imperial

FEATURES

- Inner Duraelectric D insulation, outer Duraelectric D jacket for abrasion protection
- If outer jacket is damaged, insulation color shows through providing immediate visual indication of damage

How to Order TurboFlex®					
Sample Part Number	961-035	-C	-A	-2	-4
Basic No.	TurboFlex with dual-layer Duraelectric Insulation (inner Duraelectric D .032", outer Duraelectric D .030")				
Conductor Material	-T = Tin/Copper (-65 – 150°C) -S = Silver/Copper (-65 – 200°C) -N = Nickel/Copper (-65 – 200°C)				
Wire Size (See Table I)	A, B, C, D, E, F, G				
Duraelectric D Insulation Color	See Table II (.032" thick)				
Outer Ja Duraelectric D Jacket Color	See Table II (.030" thick)				

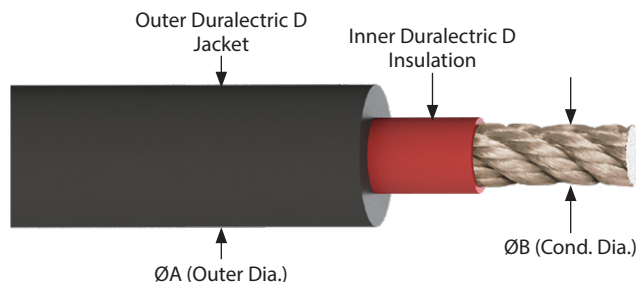

Table I: TurboFlex Wire Size, Dimensions, DC Resistance and Ampacity Ratings

AWG Code	AWG	Strand / Count / AWG	Cir Mil (nom)	Ø B in. (mm)	DC Resistance @ 20°C (Ohms / 1000 ft.)			Typical Ampacity (Amps) 40°C Ambient	
					Nickel Copper	Tin Copper	Silver	Nickel/Silver Copper	Tin Copper
A	12	7 X 37/36	6475	.099 (2.51)	1.8450	1.8620	1.7340	30-70	30-60
B	10	7 X 59/36	10325	.126 (3.20)	1.1570	1.1680	1.0880	40-90	40-75
C	8	7 X 95/36	16625	.159 (4.04)	.7188	.7252	.6755	55-135	55-115
D	6	7 X 150/36	26250	.200 (5.08)	.4551	.4593	.4278	75-185	75-155
E	4	7 X 7 X 34/36	41650	.271 (6.88)	.2979	.3006	.2800	105-250	105-215
F	2	7 X 7 X 54/36	66150	.342 (8.69)	.1876	.1893	.1763	145-345	145-290
G	1/0	7 X 7 X 86/36	105350	.431 (10.95)	.1178	.1188	.1107	195-465	195-395
H	2/0	7 X 7 X 108/36	132300	.483 (12.27)	.0938	.0946	.0882	225-540	225-460

Maximum ampacities are based on temperature rise to limits of the materials used in cable construction, based on single cable bundle in free air and at sea level pressure. Consult Glenair for more information.

Table II: Duraelectric Jacket Color

Weatherproof, halogen free, flame resistant	
0	Black
1	Brown
2	Red
3	Orange
4	Yellow
5	Kelly Green
6	Blue
7	Violet
8	Gray
9	White
OG	Dark Olive Green
DT	Desert Tan

Consult factory for other specific colors

Wire Weight and Outer Diameter

AWG Code	Weight lbs/1000 ft. (nom.)	Ø A in. (mm)	Jacket wall thickness in. (mm)
A	40.20	.223 (5.66)	.062 (1.57)
B	56.20	.250 (6.35)	
C	81.00	.283 (7.19)	
D	117.90	.324 (8.23)	
E	182.80	.395 (10.03)	
F	275.90	.466 (11.84)	
G	422.00	.555 (14.10)	
H	521.40	.607 (15.42)	

NOTES

1. Bend radius is 3X the outer diameter
2. Cable will be marked with "GLENAIR TURBOFLEX", wire gauge, part number, CAGE 06324.
3. Insulation thickness tolerance is ±.010

TurboFlex® Copper Core, Dual-Layer Duraelectric™ D Jackets and Metallic Braided Shield, 3000 VAC • 961-161 Imperial

HIGH-POWER SHIELDED • COPPER CORE

FEATURES

- Metallic braided shield provides grounding for high-power applications.
- Inner black .093" Duraelectric D Insulation to protect the conductor, surrounded with a metallic braided shield, with an outer .093" jacket for overall cable protection.

How to Order TurboFlex®				
Sample Part Number	961-161	-T	-G	-2
Basic No.	TurboFlex with Duraelectric D Insulation / Jacket (.093" / .093")			
Conductor / Shield Material	-T = Tin/Copper (-65° - 150°C) -S = Silver/Copper (-65° - 200°C) -N = Nickel/Copper (-65° - 200°C)			
Wire Size (See Table I)	R, S, A, B, C, D, E, F, G, H, I, J, K, L			
Outer Duraelectric D Jacket Color	See Table II			

AWG Code	AWG	Strand/ Count/ AWG	Cir Mil (nom)	Ø A Conductor in. (mm)	ØE in. (mm)	"B" Insulation Wall Thickness in. (mm)	"C" Shield Thickness in. (mm)	"D" Outer Jacket Wall Thickness in. (mm)
R	16	7 X 15/36	2625	.063 (1.60)	.457 (11.61)	.093 (2.36)	.011 (0.28)	.093 (2.36)
S	14	7 X 24/36	4200	.080 (2.03)	.474 (12.04)			
A	12	7 X 37/36	6475	.099 (2.51)	.493 (12.52)			
B	10	7 X 59/36	10325	.126 (3.20)	.520 (13.21)			
C	8	7 X 95/36	16625	.159 (4.04)	.553 (14.05)			
D	6	7 X 150/36	26250	.200 (5.08)	.594 (15.09)			
E	4	7 X 7 X 34/36	41650	.271 (6.88)	.665 (16.89)			
F	2	7 X 7 X 54/36	66150	.342 (8.69)	.736 (18.69)			
G	1/0	7 X 7 X 86/36	105350	.431 (10.95)	.825 (20.96)			
H	2/0	7 X 7 X 108/36	132300	.483 (12.27)	.877 (22.28)			
I	3/0	19 X 7 X 51/36	169575	.547 (13.89)	.941 (23.90)			
J	4/0	19 X 7 X 64/36	212800	.613 (15.57)	1.007 (25.58)			
K	250 MCM	19 X 7 X 75/36	249375	.663 (16.84)	1.057 (26.85)			
M	350 MCM	19 X 7 X 106/36	352450	.789 (20.04)	1.183 (30.05)			
L	450 MCM	19 X 7 X 135/36	448875	.890 (22.61)	1.284 (32.61)			

Weatherproof, halogen free, flame resistant	
0	Black
1	Brown
2	Red
3	Orange
4	Yellow
5	Kelly Green
6	Blue
7	Violet
8	Gray
9	White
OG	Dark Olive Green
DT	Desert Tan

Consult factory for other specific colors

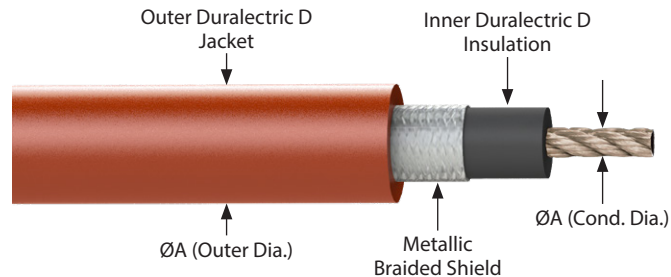

NOTES

1. Bend radius is 4X the outer diameter
2. Cable will be marked with "GLENAIR TURBOFLEX", wire gauge, part number, CAGE 06324.
3. Jacket thickness tolerance is ±10%
4. Braided shield has 90% optical coverage

TurboFlex® Copper Core, Dual-Layer Duralectric™ D Jackets and Metallic Braided Shield, 3000 VAC • 961-161 Imperial

Table I: TurboFlex DC Resistance and Ampacity Ratings

AWG Code	DC Resistance @ 20°C (Ohms / 1000 ft.)			Ampacity (Amps) 40°C Ambient		Braided Shield Ampacity (Amps) 30°C Ambient
	Nickel Copper	Tin Copper	Silver Copper	Nickel Copper	Tin/Silver Copper	
R	4.5510	4.5930	4.2780	40	36	53
S	2.8450	2.8710	2.6740	59	54	35
A	1.8450	1.8620	1.7340	78	68	35
B	1.1570	1.1680	1.0880	107	90	42
C	.7188	.7252	.6755	142	124	42
D	.4551	.4593	.4278	205	165	53
E	.2979	.3006	.2800	278	220	55
F	.1876	.1893	.1763	381	293	62
G	.1178	.1188	.1107	532	399	70
H	.0938	.0946	.0882	591	467	77
I	.0738	.0745	.0694	708	546	77
J	.0588	.0594	.0553	830	629	71
K	.0502	.0507	.0472	910	705	71
M	.355	.359	.334	1140	880	71
L	.0279	.0282	.0262	1320	1020	80

Maximum ampacities are based on temperature rise to limits of the materials used in cable construction, based on single cable bundle in free air and at sea level pressure. Consult Glenair for more information.

Ampacity Ratings: Ambient Temperature Correction Factors

Ambient Temp (°C)	Correction Factor
41 – 50	0.97
51 – 60	0.94
61 – 70	0.90
71 – 80	0.87
81 – 90	0.83
91 – 100	0.79
101 – 120	0.71
121 – 140	0.61
141 – 160	0.50
161 – 180	0.35
181 – 200	----
201 – 255	----

For ambient temperatures other than 40°C (104°F), multiply the allowable ampacities from the table above by the appropriate factor below

HIGH-POWER SHIELDED • COPPER CORE

TurboFlex® Copper Core, Dual-Layer Duraelectric™ D Insulation/Jacket, Metallic Braided Shield, 3000 VAC • 961-007 Imperial

HIGH-POWER SHIELDED • COPPER CORE

FEATURES

- Metallic braided shield provides grounding for high-power applications.
- Inner black Duraelectric D insulation to protect the conductor, surrounded with a metallic braided shield, with an outer jacket for overall cable protection.

How to Order TurboFlex®				
Sample Part Number	961-007	-T	-A	-2
Basic No.	TurboFlex with Duraelectric D Insulation/Jacket (.062")			
Conductor / Braided Shield Material	-T = Tin/Copper (-65° - 150°C) -S = Silver/Copper (-65° - 200°C) -N = Nickel/Copper (-65° - 200°C)			
Wire Size (See Table I)	R, S, A, B, C, D, E, F, G, H, I, J, K, M, L			
Outer Duraelectric D Jacket Color	See Table II			

AWG Code	AWG	Strand / Count / AWG	Cir Mil (nom)	Ø A in. (mm)	"B" Insulation Wall Thickness in. (mm)	"C" Shield Thickness in. (mm)	"D" Outer Jacket Wall Thickness in. (mm)	Ø E in. (mm)
R	16	7 X 15/36	2625	.063 (1.60)	.062 (1.57)	.011 (0.28)	.062 (1.57)	.333 (8.46)
S	14	7 X 24/36	4200	.080 (2.03)				.350 (8.89)
A	12	7 X 37/36	6475	.099 (2.51)				.369 (9.37)
B	10	7 X 59/36	10325	.126 (3.20)				.396 (10.06)
C	8	7 X 95/36	16625	.159 (4.04)				.429 (10.90)
D	6	7 X 150/36	26250	.200 (5.08)				.470 (11.94)
E	4	7 X 7 X 34/36	41650	.271 (6.88)				.541 (13.74)
F	2	7 X 7 X 54/36	66150	.342 (8.69)				.612 (15.54)
G	1/0	7 X 7 X 86/36	105350	.431 (10.95)				.701 (17.81)
H	2/0	7 X 7 X 108/36	132300	.483 (12.27)				.753 (19.13)
I	3/0	19 X 7 X 51/36	169575	.547 (13.89)				.817 (20.75)
J	4/0	19 X 7 X 64/36	212800	.613 (15.57)				.883 (22.43)
K	250 MCM	19 X 7 X 75/36	249375	.663 (16.84)				.933 (23.70)
M	350 MCM	19 X 7 X 106/36	352450	.789 (20.04)				1.059 (26.90)
L	450 MCM	19 X 7 X 135/36	448875	.890 (22.61)	1.160 (29.46)			

Weatherproof, halogen free, flame resistant	
0	Black
1	Brown
2	Red
3	Orange
4	Yellow
5	Kelly Green
6	Blue
7	Violet
8	Gray
9	White
OG	Dark Olive Green
DT	Desert Tan

Consult factory for other specific colors

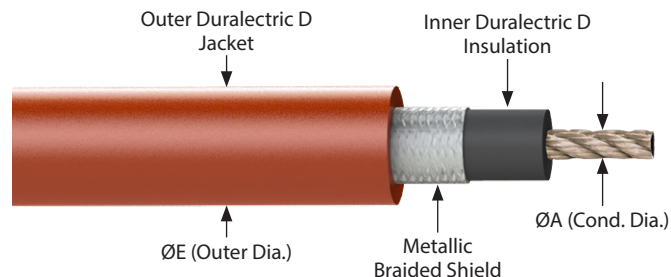

NOTES

1. Bend radius is 4X the outer diameter
2. Cable will be marked with "GLENAIR TURBOFLEX", wire gauge, part number, CAGE 06324.
3. Insulation thickness tolerance is ±10%
4. Braided shield has 90% optical coverage

TurboFlex® Copper Core, Dual-Layer Duralectric™ D Insulation/Jacket, Metallic Braided Shield, 3000 VAC • 961-007 Imperial

Table I: TurboFlex DC Resistance and Ampacity Ratings

AWG Code	DC Resistance @ 20°C (Ohms / 1000 ft.)			Typical Ampacity (Amps) 40°C Ambient		Braided Shield Ampacity (Amps) 30°C Ambient
	Nickel Copper	Tin Copper	Silver Copper	Nickel/Silver Copper	Tin Copper	
R	4.5510	4.5930	4.2780	15-35	15-30	32
S	2.8450	2.8710	2.6740	20-50	20-45	46
A	1.8450	1.8620	1.7340	30-70	30-60	46
B	1.1570	1.1680	1.0880	40-90	40-75	53
C	.7188	.7252	.6755	55-135	55-115	35
D	.4551	.4593	.4278	75-185	75-155	42
E	.2979	.3006	.2800	105-250	105-215	53
F	.1876	.1893	.1763	145-345	145-290	55
G	.1178	.1188	.1107	195-465	195-395	62
H	.0938	.0946	.0882	225-540	225-460	70
I	.0738	.0745	.0694	260-640	260-540	77
J	.0588	.0594	.0553	310-755	310-640	77
K	.0502	.0507	.0472	315-760	315-645	88
M	.0355	.0359	.0334	380-910	380-775	71
L	.0279	.0282	.0262	440-1040	440-890	80

Maximum ampacities are based on temperature rise to limits of the materials used in cable construction, based on single cable bundle in free air and at sea level pressure. Consult Glenair for more information.

Ampacity Ratings: Ambient Temperature Correction Factors

Ambient Temp (°C)	Correction Factor
For ambient temperatures other than 40°C (104°F), multiply the allowable ampacities from the table above by the appropriate factor below	
41 - 50	0.97
51 - 60	0.94
61 - 70	0.90
71 - 80	0.87
81 - 90	0.83
91 - 100	0.79
101 - 120	0.71
121 - 140	0.61
141 - 160	0.50
161 - 180	0.35
181 - 200	----
201 - 255	----

HIGH-POWER SHIELDED • COPPER CORE

TurboFlex® Copper Core, Dual-Layer Duraelectric™ D Insulation/Jacket, Metallic Braided Shield, 3000 VAC • 961-005 Metric

HIGH-POWER SHIELDED • COPPER CORE

FEATURES

- Metallic braided shield provides grounding for high-power applications.
- Inner black Duraelectric D Insulation to protect the conductor, surrounded with a metallic braided shield, with an outer jacket for overall cable protection.

How to Order TurboFlex®				
Sample Part Number	961-005	-T	-A	-2
Basic No.	TurboFlex with Duraelectric D Insulation / Jacket (1.57mm)			
Conductor / Braided Shield Material	-T = Tin/Copper (-65° - 150°C) -S = Silver/Copper (-65° - 200°C) -N = Nickel/Copper (-65° - 200°C)			
Wire Size (See Table I)	A, B, C, D, E, F, G, H, I, J, K, L, M			
Outer Duraelectric D Jacket Color	See Table II			

Table I: TurboFlex Wire Size, Dimensions

AWG Code	mm²	Strand / Count / AWG	Ø A mm	"B" Insulation Wall Thickness mm	"C" Shield Thickness mm	"D" Outer Jacket Wall Thickness mm	Ø E mm
A	4	7 X 37/36	2.52	1.57	.28	1.57	9.36
B	6	7 X 59/36	3.20				10.04
C	10	7 X 95/36	4.04				10.88
D	16	7 X 150/36	5.08				11.92
E	25	7 X 7 X 34/36	6.88				13.72
F	35	7 X 7 X 54/36	8.69				15.53
G	50	7 X 7 X 86/36	10.95				17.79
H	70	19 X 7 X 42/36	12.60				19.44
I	95	19 X 7 X 51/36	13.90				20.74
J	120	19 X 7 X 75/36	16.84				23.68
K	150	19 X 7 X 91/36	18.57				25.41
L	185	19 X 7 X 106/36	20.04				26.88
M	240	19 X 7 X 135/36	22.61				29.45

*Metric equivalent to 36AWG is 0.0127mm²

Table II: Duraelectric™ D Jacket Color

Weatherproof, halogen free, flame resistant	
0	Black
1	Brown
2	Red
3	Orange
4	Yellow
5	Kelly Green
6	Blue
7	Violet
8	Gray
9	White
OG	Dark Olive Green
DT	Desert Tan

Consult factory for other specific colors

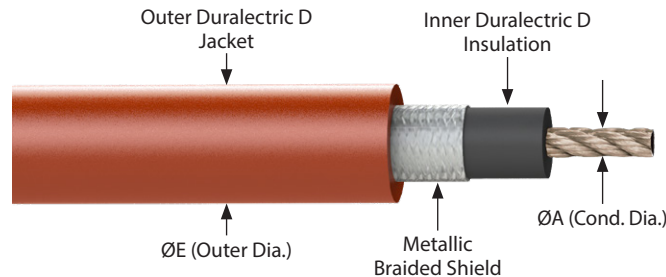

NOTES

1. Bend radius is 4X the outer diameter
2. Cable will be marked with "GLENAIR TURBOFLEX", wire gauge, part number, CAGE 06324.
3. Jacket thickness tolerance is ±10%
4. Braided shield has 90% optical coverage

TurboFlex® Copper Core, Dual-Layer Duralectric™ D Insulation/Jacket, Metallic Braided Shield, 3000 VAC • 961-005 Metric

Table I: TurboFlex DC Resistance and Ampacity Ratings

AWG Code	DC Resistance @ 20°C (Ohms / 1000m)			Ampacity (Amps) 40°C Ambient		Braided Shield Ampacity (Amps) 30°C Ambient
	Nickel Copper	Tin Copper	Silver Copper	Nickel Copper	Tin/Silver Copper	
A	6.0516	6.1074	5.6875	78	68	46
B	3.7950	3.8310	3.5686	107	90	53
C	2.3577	2.3787	2.2156	142	124	35
D	1.4927	1.5065	1.4032	205	165	42
E	.9771	.9860	.9184	278	220	53
F	.6153	.6209	.5783	381	293	55
G	.3864	.3897	.3631	532	399	62
H	.2942	.2968	.2765	----	----	70
I	.2421	.2444	.2276	708	546	77
J	.1647	.1663	.1548	910	705	88
K	.1358	.1371	.1276	----	----	71
L	.1164	.1178	.1096	1140	880	71
M	.0915	.0925	.0859	1320	1020	80

Maximum ampacities are based on temperature rise to limits of the materials used in cable construction, based on single cable bundle in free air and at sea level pressure. Consult Glenair for more information.

Ampacity Ratings: Ambient Temperature Correction Factors

Ambient Temp (°C)	For ambient temperatures other than 40°C (104°F), multiply the allowable ampacities from the table above by the appropriate factor below
41 – 50	0.97
51 – 60	0.94
61 – 70	0.90
71 – 80	0.87
81 – 90	0.83
91 – 100	0.79
101 – 120	0.71
121 – 140	0.61
141 – 160	0.50
161 – 180	0.35
181 – 200	----
201 – 255	----

HIGH-POWER SHIELDED • COPPER CORE

**TurboFlex® Copper, Dual-Layer Duraelectric™ D Thin-Wall Insulation/
Jacket, Metallic Braided Shield, 2000 VAC • 961-129 Imperial**

HIGH-POWER SHIELDED • COPPER CORE

FEATURES

- Metallic braided shield provides grounding for high-power applications.
- Inner black thin-wall Duraelectric D insulation to protect the conductor, surrounded with a metallic braided shield, with an outer thin-wall jacket for overall cable protection.

How to Order TurboFlex®				
Sample Part Number	961-129	-T	-A	-2
Basic No.	TurboFlex with thin-wall Duraelectric D Insulation / Jacket (.032"/.030")			
Conductor / Shield Material	-T = Tin/Copper (-65° - 150°C) -S = Silver/Copper (-65° - 200°C) -N = Nickel/Copper (-65° - 200°C)			
Wire Size (See Table I)	T, R, S, A, B, C, D, E, F, G, H, I, J			
Outer Duraelectric D Jacket Color	See Table II			

Table I: TurboFlex Wire Size, Dimensions								
AWG Code	AWG	Strand / Count / AWG	Cir Mil (nom)	Ø A in. (mm)	"B" Insulation Wall Thickness in. (mm)	"C" Shield Thickness in. (mm)	"D" Outer Jacket Wall Thickness in. (mm)	Ø E in. (mm)
T	20	42/36	1050	.037 (0.94)	0.032 (0.81)	0.011 (0.28)	0.030 (0.76)	0.183 (4.65)
R	16	7 X 15/36	2625	.063 (1.60)				0.209 (5.31)
S	14	7 X 24/36	4200	.080 (2.03)				0.226 (5.74)
A	12	7 X 37/36	6475	.099 (2.51)				0.245 (6.22)
B	10	7 X 59/36	10325	.126 (3.20)				0.272 (6.91)
C	8	7 X 95/36	16625	.159 (4.04)				0.305 (7.75)
D	6	7 X 150/36	26250	.200 (5.08)				0.346 (8.79)
E	4	7 X 7 X 34/36	41650	.271 (6.88)				0.417 (10.59)
F	2	7 X 7 X 54/36	66150	.342 (8.69)				0.488 (12.40)
G	1/0	7 X 7 X 86/36	105350	.431 (10.95)				0.577 (14.66)
H	2/0	7 X 7 X 108/36	132300	.483 (12.27)				0.629 (15.98)
I	3/0	19 X 7 X 51/36	169575	.547 (13.89)				0.693 (17.60)
J	4/0	19 X 7 X 64/36	212800	.613 (15.57)	0.759 (19.28)			

Table II: Duraelectric™ D Jacket Color	
Weatherproof, halogen free, flame resistant	
0	Black
1	Brown
2	Red
3	Orange
4	Yellow
5	Kelly Green
6	Blue
7	Violet
8	Gray
9	White
Consult factory for other specific colors	

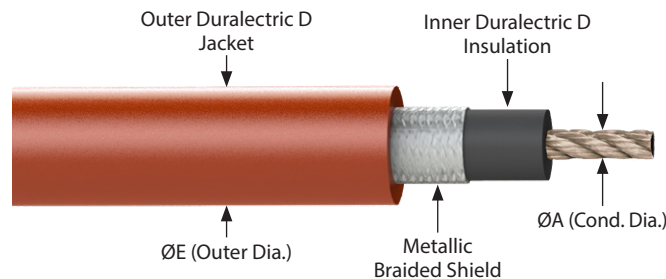

NOTES

1. Bend radius is 4X the outer diameter
2. Cable will be marked with "GLENAIR TURBOFLEX", wire gauge, part number, CAGE 06324.
3. Jacket thickness tolerance is ±.005
4. Braided shield has 90% optical coverage

**TurboFlex® Copper, Dual-Layer Duralectric™ D Thin-Wall Insulation/
Jacket, Metallic Braided Shield, 2000 VAC • 961-129 Imperial**

Table I: TurboFlex DC Resistance and Ampacity Ratings

AWG Code	DC Resistance @ 20°C (Ohms / 1000 ft.)			Ampacity (Amps) 40°C Ambient		Braided Shield Ampacity (Amps) 30°C Ambient
	Nickel Copper	Tin Copper	Silver Copper	Nickel/Silver Copper	Tin Copper	
T	10.7178	10.7538	10.0747	10-25	10-20	16
R	4.5510	4.5930	4.2780	15-35	15-30	25
S	2.8450	2.8710	2.6740	20-50	20-45	25
A	1.8450	1.8620	1.7340	30-70	30-60	32
B	1.1570	1.1680	1.0880	40-90	40-75	32
C	0.7188	0.7252	0.6755	55-135	55-115	46
D	0.4551	0.4593	0.4278	75-185	75-155	35
E	0.2979	0.3006	0.2800	105-250	105-215	42
F	0.1876	0.1893	0.1763	145-345	145-290	53
G	0.1178	0.1188	0.1107	195-465	195-395	62
H	0.0938	0.0946	0.0882	225-540	225-460	62
I	0.0738	0.0745	0.0694	260-640	260-540	70
J	0.0588	0.0594	0.0553	310-755	310-640	77

Maximum ampacities are based on temperature rise to limits of the materials used in cable construction, based on single cable bundle in free air and at sea level pressure. Consult Glenair for more information.

Ampacity Ratings: Ambient Temperature Correction Factors

Ambient Temp (°C)	For ambient temperatures other than 40°C (104°F), multiply the allowable ampacities from the table above by the appropriate factor below
41 - 50	0.97
51 - 60	0.94
61 - 70	0.90
71 - 80	0.87
81 - 90	0.83
91 - 100	0.79
101 - 120	0.71
121 - 140	0.61
141 - 160	0.50
161 - 180	0.35
181 - 200	-----
201 - 255	-----

HIGH-POWER SHIELDED • COPPER CORE

**TurboFlex® Copper, Dual-Layer Duraelectric™ D Ultra-Thin Insulation/
Jacket, Metallic Braided Shield, 1000 VAC • 961-143 Imperial**

HIGH-POWER SHIELDED • COPPER CORE

FEATURES

- Metallic braided shield provides grounding for high-power applications.
- Inner black ultra thin-wall Duraelectric D insulation to protect the conductor, surrounded with a metallic braided shield, with an outer ultra thin-wall jacket for overall cable protection.

How to Order TurboFlex®				
Sample Part Number	961-143	-T	-A	-2
Basic No.	TurboFlex with ultra-thin Duraelectric D Insulation/Jacket (.016"/.016")			
Conductor / Shield Material	-T = Tin/Copper (-65° - 150°C) -S = Silver/Copper (-65° - 200°C) -N = Nickel/Copper (-65° - 200°C)			
Wire Size (See Table I)	T, R, S, A, B, C, D, E, F, G			
Outer Duraelectric D Jacket Color	See Table II			

Table I: TurboFlex Wire Size, Dimensions								
AWG Code	AWG	Strand / Count / AWG	Cir Mil (nom)	Ø A in. (mm)	"B" Insulation Wall Thickness in. (mm)	"C" Shield Thickness in. (mm)	"D" Outer Jacket Wall Thickness in. (mm)	Ø E in. (mm)
T	20	42/36	1050	.037 (0.94)	.016 (0.41)	0.011 (0.28)	.016 (0.41)	.123 (3.12)
R	16	7 X 15/36	2625	.063 (1.60)				.149 (3.78)
S	14	7 X 24/36	4200	.080 (2.03)				.166 (4.22)
A	12	7 X 37/36	6475	.099 (2.51)				.185 (4.70)
B	10	7 X 59/36	10325	.126 (3.20)				.212 (5.38)
C	8	7 X 95/36	16625	.159 (4.04)				.245 (6.22)
D	6	7 X 150/36	26250	.200 (5.08)				.286 (7.26)
E	4	7 X 7 X 34/36	41650	.271 (6.88)				.357 (9.07)
F	2	7 X 7 X 54/36	66150	.342 (8.69)				.428 (10.87)
G	1/0	7 X 7 X 86/36	105350	.431 (10.95)				.517 (13.13)

Table II: Duraelectric™ D Jacket Color	
Weatherproof, halogen free, flame resistant	
0	Black
1	Brown
2	Red
3	Orange
4	Yellow
5	Kelly Green
6	Blue
7	Violet
8	Gray
9	White
Consult factory for other specific colors	

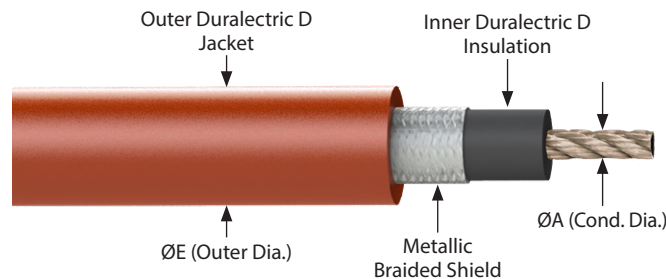

NOTES

1. Bend radius is 4X the outer diameter
2. Cable will be marked with "GLENAIR TURBOFLEX", wire gauge, part number, CAGE 06324.
3. Jacket thickness tolerance is ±.002
4. Braided shield has 90% optical coverage

**TurboFlex® Copper, Dual-Layer Duralectric™ D Ultra-Thin Insulation/
Jacket, Metallic Braided Shield, 1000 VAC • 961-143 Imperial**

Table I: TurboFlex DC Resistance and Ampacity Ratings						
AWG Code	DC Resistance @ 20°C (Ohms / 1000 ft.)			Ampacity (Amps) 40°C Ambient		Braided Shield Ampacity (Amps) 30°C Ambient
	Nickel Copper	Tin Copper	Silver Copper	Nickel Copper	Tin/Silver Copper	
T	10.7178	10.7538	10.0747	16	14	11
R	4.5510	4.5930	4.2780	40	36	16
S	2.8450	2.8710	2.6740	59	54	19
A	1.8450	1.8620	1.7340	78	68	25
B	1.1570	1.1680	1.0880	107	90	40
C	0.7188	0.7252	0.6755	142	124	32
D	0.4551	0.4593	0.4278	205	165	46
E	0.2979	0.3006	0.2800	278	220	35
F	0.1876	0.1893	0.1763	381	293	53
G	0.1178	0.1188	0.1107	532	399	55

Ampacity Ratings: Ambient Temperature Correction Factors	
Ambient Temp (°C)	For ambient temperatures other than 40°C (104°F), multiply the allowable ampacities from the table above by the appropriate factor below
41 – 50	0.97
51 – 60	0.94
61 – 70	0.90
71 – 80	0.87
81 – 90	0.83
91 – 100	0.79
101 – 120	0.71
121 – 140	0.61
141 – 160	0.50
161 – 180	0.35
181 – 200	----
201 – 255	----

HIGH-POWER SHIELDED • COPPER CORE

TurboFlex® Copper, Dual-Layer Duraelectric™ D Insulation/Jacket, Microfilament Braided Shield, 3000 VAC • 961-163 Imperial

MICROFILAMENT BRAIDED • COPPER CORE

FEATURES

- Glenair microfilament braided shield (ArmorLite™ or AmberStrand) provides lightweight grounding.
- Black Duraelectric D insulation to protect the conductor, surrounded with a lightweight microfilament braided shield, with an outer jacket for overall cable protection.

How to Order TurboFlex®					
Sample Part Number	961-163	-T	-AM	-A	-2
Basic No.	TurboFlex with .093" Duraelectric D Insulation / Jacket				
Conductor Material	-T = Tin/Copper (-65° - 150°C) -S = Silver/Copper (-65° - 200°C) -N = Nickel/Copper (-65° - 200°C)				
Braided Shield Material	-AM = AmberStrand -AR = ArmorLite -CF = ArmorLite CF				
Wire Size (See Table I)	R, S, A, B, C, D, E, F, G, H, I, J, K, M, L				
Outer Duraelectric D Jacket Color	See Table II				

AWG Code	AWG	Strand/ Count/ AWG	Cir Mil (nom)	Ø A Conductor in. (mm)	ØE in. (mm)	"B" Insulation Wall Thickness in. (mm)	"C" Shield Thickness in. (mm)	"D" Outer Jacket Wall Thickness in. (mm)
R	16	7 X 15/36	2625	.063 (1.60)	.457 (11.61)	.093 (2.36)	.011 (0.28)	.093 (2.36)
S	14	7 X 24/36	4200	.080 (2.03)	.474 (12.04)			
A	12	7 X 37/36	6475	.099 (2.51)	.493 (12.52)			
B	10	7 X 59/36	10325	.126 (3.20)	.520 (13.21)			
C	8	7 X 95/36	16625	.159 (4.04)	.553 (14.05)			
D	6	7 X 150/36	26250	.200 (5.08)	.594 (15.09)			
E	4	7 X 7 X 34/36	41650	.271 (6.88)	.665 (16.89)			
F	2	7 X 7 X 54/36	66150	.342 (8.69)	.736 (18.69)			
G	1/0	7 X 7 X 86/36	105350	.431 (10.95)	.825 (20.96)			
H	2/0	7 X 7 X 108/36	132300	.483 (12.27)	.877 (22.28)			
I	3/0	19 X 7 X 51/36	169575	.547 (13.89)	.941 (23.90)			
J	4/0	19 X 7 X 64/36	212800	.613 (15.57)	1.007 (25.58)			
K	250 MCM	19 X 7 X 75/36	249375	.663 (16.84)	1.057 (26.85)			
M	350 MCM	19 X 7 X 106/36	352450	.789 (20.04)	1.183 (30.05)			
L	450 MCM	19 X 7 X 135/36	448875	.890 (22.61)	1.284 (32.61)			

Weatherproof, halogen free, flame resistant	
0	Black
1	Brown
2	Red
3	Orange
4	Yellow
5	Kelly Green
6	Blue
7	Violet
8	Gray
9	White
OG	Dark Olive Green
DT	Desert Tan

Consult factory for other specific colors

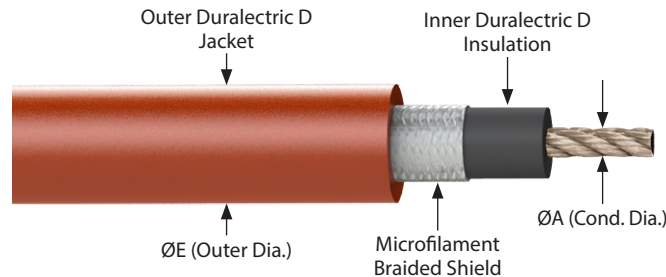

NOTES

1. Bend radius is 4X the outer diameter
2. Cable will be marked with "GLENAIR TURBOFLEX", wire gauge, part number, CAGE 06324.
3. Jacket thickness tolerance is ±10%
4. Braided shield has 90% optical coverage

TurboFlex® Copper, Dual-Layer Duralectric™ D Insulation/Jacket, Microfilament Braided Shield, 3000 VAC • 961-163 Imperial

Table I: TurboFlex DC Resistance and Ampacity Ratings					
AWG Code	DC Resistance @ 20°C (Ohms / 1000 ft.)			Ampacity (Amps) 40°C Ambient	
	Nickel Copper	Tin Copper	Silver Copper	Nickel Copper	Tin/Silver Copper
R	4.5510	4.5930	4.2780	40	36
S	2.8450	2.8710	2.6740	59	54
A	1.8450	1.8620	1.7340	78	68
B	1.1570	1.1680	1.0880	107	90
C	.7188	.7252	.6755	142	124
D	.4551	.4593	.4278	205	165
E	.2979	.3006	.2800	278	220
F	.1876	.1893	.1763	381	293
G	.1178	.1188	.1107	532	399
H	.0938	.0946	.0882	591	467
I	.0738	.0745	.0694	708	546
J	.0588	.0594	.0553	830	629
K	.0502	.0507	.0472	910	705
M	.0355	.0359	.0334	1140	880
L	.0279	.0282	.0262	1320	1020

Maximum ampacities are based on temperature rise to limits of the materials used in cable construction, based on single cable bundle in free air and at sea level pressure. Consult Glenair for more information.

Ampacity Ratings: Ambient Temperature Correction Factors	
Ambient Temp (°C)	For ambient temperatures other than 40°C (104°F), multiply the allowable ampacities from the table above by the appropriate factor below
41 – 50	0.97
51 – 60	0.94
61 – 70	0.90
71 – 80	0.87
81 – 90	0.83
91 – 100	0.79
101 – 120	0.71
121 – 140	0.61
141 – 160	0.50
161 – 180	0.35
181 – 200	----
201 – 255	----

MICROFILAMENT BRAIDED • COPPER CORE

TurboFlex® Copper, Dual-Layer Duraelectric™ D Insulation/Jacket, Microfilament Braided Shield, 3000 VAC • 961-153 Imperial

MICROFILAMENT BRAIDED • COPPER CORE

FEATURES

- Glenair microfilament braided shield (ArmorLite™ or AmberStrand) provides lightweight grounding.
- Black Duraelectric D insulation to protect the conductor, surrounded with a lightweight microfilament braided shield, with an outer jacket for overall cable protection.

How to Order TurboFlex®					
Sample Part Number	961-153	-T	-AM	-A	-2
Basic No.	TurboFlex with .062" Duraelectric D Insulation / Jacket				
Conductor Material	-T = Tin/Copper (-65° - 150°C) -S = Silver/Copper (-65° - 200°C) -N = Nickel/Copper (-65° - 200°C)				
Braided Shield Material	-AM = AmberStrand -AR = ArmorLite -CF = ArmorLite CF				
Wire Size (See Table I)	R, S, A, B, C, D, E, F, G, H, I, J, K, M, L				
Outer Duraelectric D Jacket Color	See Table II				

Table I: TurboFlex Wire Size, Dimensions

AWG Code	AWG	Strand / Count / AWG	Cir Mil (nom)	Ø A in. (mm)	"B" Insulation Wall Thickness in. (mm)	"C" Shield Thickness in. (mm)	"D" Outer Jacket Wall Thickness in. (mm)	Ø E in. (mm)
R	16	7 X 15/36	2625	.063 (1.60)	.062 (1.57)	.008 (0.20)	.062 (1.57)	.327 (8.31)
S	14	7 X 24/36	4200	.080 (2.03)				.344 (8.74)
A	12	7 X 37/36	6475	.099 (2.51)				.363 (9.22)
B	10	7 X 59/36	10325	.126 (3.20)				.390 (9.91)
C	8	7 X 95/36	16625	.159 (4.04)				.423 (10.74)
D	6	7 X 150/36	26250	.200 (5.08)				.464 (11.79)
E	4	7 X 7 X 34/36	41650	.271 (6.88)				.535 (13.59)
F	2	7 X 7 X 54/36	66150	.342 (8.69)				.606 (15.39)
G	1/0	7 X 7 X 86/36	105350	.431 (10.95)				.695 (17.65)
H	2/0	7 X 7 X 108/36	132300	.483 (12.27)				.747 (18.97)
I	3/0	19 X 7 X 51/36	169575	.547 (13.89)				.811 (20.60)
J	4/0	19 X 7 X 64/36	212800	.613 (15.57)				.877 (22.28)
K	250 MCM	19 X 7 X 75/36	249375	.663 (16.84)				.927 (23.55)
M	350 MCM	19 X 7 X 106/36	352450	.789 (20.04)				1.053 (26.75)
L	450 MCM	19 X 7 X 135/36	448875	.890 (22.61)	1.154 (29.31)			

Temperature Ratings in °C are dependent on selected conductor and shield material

Shield Material	Conductor Material		
	Tin (-65°/+150°)	Silver (-65°/+200°)	Nickel (-65°/+200°)
AmberStrand (-80°/+220°)	-65° / +150°	-65° / +200°	-65° / +220°
ArmorLite (-80°/+260°)	-65° / +150°	-65° / +200°	-65° / +200°
ArmorLite CF (-80°/+400°)	-65° / +150°	-65° / +200°	-65° / +200°

Table II: Duraelectric™ D Jacket Color

Weatherproof, halogen free, flame resistant	
0	Black
1	Brown
2	Red
3	Orange
4	Yellow
5	Kelly Green
6	Blue
7	Violet
8	Gray
9	White

Consult factory for other specific colors

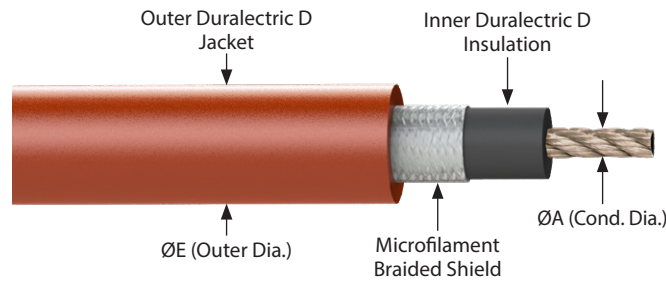

NOTES

1. Bend radius is 4X the outer diameter
2. Cable will be marked with "GLENAIR TURBOFLEX", wire gauge, part number, CAGE 06324.
3. Jacket thickness tolerance is ±10%
4. Braided shield has 90% optical coverage

TurboFlex® Copper, Dual-Layer Duralectric™ D Insulation/Jacket, Microfilament Braided Shield, 3000 VAC • 961-153 Imperial

Table I: TurboFlex DC Resistance and Ampacity Ratings

AWG Code	DC Resistance @ 20°C (Ohms / 1000 ft.)			Ampacity (Amps) 40°C Ambient	
	Nickel Copper	Tin Copper	Silver Copper	Nickel Copper	Tin/Silver Copper
R	4.5510	4.5930	4.2780	40	36
S	2.8450	2.8710	2.6740	59	54
A	1.8450	1.8620	1.7340	78	68
B	1.1570	1.1680	1.0880	107	90
C	.7188	.7252	.6755	142	124
D	.4551	.4593	.4278	205	165
E	.2979	.3006	.2800	278	220
F	.1876	.1893	.1763	381	293
G	.1178	.1188	.1107	532	399
H	.0938	.0946	.0882	591	467
I	.0738	.0745	.0694	708	546
J	.0588	.0594	.0553	830	629
K	.0502	.0507	.0472	910	705
M	.0355	.0359	.0334	1140	880
L	.0279	.0282	.0262	1320	1020

Maximum ampacities are based on temperature rise to limits of the materials used in cable construction, based on single cable bundle in free air and at sea level pressure. Consult Glenair for more information.

Ampacity Ratings: Ambient Temperature Correction Factors

Ambient Temp (°C)	Correction Factor
41 – 50	0.97
51 – 60	0.94
61 – 70	0.90
71 – 80	0.87
81 – 90	0.83
91 – 100	0.79
101 – 120	0.71
121 – 140	0.61
141 – 160	0.50
161 – 180	0.35
181 – 200	----
201 – 255	----

For ambient temperatures other than 40°C (104°F), multiply the allowable ampacities from the table above by the appropriate factor below

MICROFILAMENT BRAIDED • COPPER CORE

TurboFlex® Copper, Dual-Layer Duraelectric™ D Insulation/Jacket, Microfilament Braided Shield, 2000 VAC • 961-155 Imperial

MICROFILAMENT BRAIDED • COPPER CORE

FEATURES

- Glenair microfilament braided shield (ArmorLite™ or AmberStrand) provides lightweight grounding.
- Black Duraelectric D insulation to protect the conductor, surrounded with a lightweight microfilament braided shield, with an outer jacket for overall cable protection.

How to Order TurboFlex®			
Sample Part Number	961-155	-T	-AM -A -2
Basic No.	TurboFlex with .032" / .030" Duraelectric D Insulation / Jacket		
Conductor Material	-T = Tin/Copper (-65° - 150°C) -S = Silver/Copper (-65° - 200°C) -N = Nickel/Copper (-65° - 200°C)		
Braided Shield Material	-AM = AmberStrand -AR = ArmorLite -CF = ArmorLite CF		
Wire Size (See Table I)	T, R, S, A, B, C, D, E, F, G, H, I, J		
Outer Duraelectric D Jacket Color	See Table II		

AWG Code	AWG	Strand / Count / AWG	Cir Mil (nom)	Ø A in. (mm)	"B" Insulation Wall Thickness in. (mm)	"C" Shield Thickness in. (mm)	"D" Outer Jacket Wall Thickness in. (mm)	Ø E in. (mm)
T	20	42/36	1050	.037 (0.94)	.032 (0.81)	.008 (0.20)	.030 (0.76)	.177 (4.50)
R	16	7 X 15/36	2625	.063 (1.60)				.203 (5.16)
S	14	7 X 24/36	4200	.080 (2.03)				.220 (5.59)
A	12	7 X 37/36	6475	.099 (2.51)				.239 (6.07)
B	10	7 X 59/36	10325	.126 (3.20)				.266 (6.76)
C	8	7 X 95/36	16625	.159 (4.04)				.299 (7.59)
D	6	7 X 150/36	26250	.200 (5.08)				.340 (8.64)
E	4	7 X 7 X 34/36	41650	.271 (6.88)				.411 (10.44)
F	2	7 X 7 X 54/36	66150	.342 (8.69)				.482 (12.24)
G	1/0	7 X 7 X 86/36	105350	.431 (10.95)				.571 (14.50)
H	2/0	7 X 7 X 108/36	132300	.483 (12.27)	.623 (15.82)			
I	3/0	19 X 7 X 51/36	169575	.547 (13.89)	.687 (17.45)			
J	4/0	19 X 7 X 64/36	212800	.613 (15.57)	.753 (19.13)			

Shield Material	Conductor Material		
	Tin (-65°/+150°)	Silver (-65°/+200°)	Nickel (-65°/+200°)
AmberStrand (-80°/+220°)	-65° / +150°	-65° / +200°	-65° / +220°
ArmorLite (-80°/+260°)	-65° / +150°	-65° / +200°	-65° / +200°
ArmorLite CF (-80°/+400°)	-65° / +150°	-65° / +200°	-65° / +200°

Weatherproof, halogen free, flame resistant	
0	Black
1	Brown
2	Red
3	Orange
4	Yellow
5	Kelly Green
6	Blue
7	Violet
8	Gray
9	White

Consult factory for other specific colors

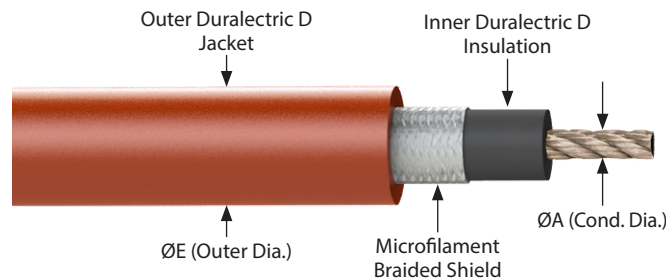

NOTES

- Bend radius is 4X the outer diameter
- Cable will be marked with "GLENAIR TURBOFLEX", wire gauge, part number, CAGE 06324.
- Jacket thickness tolerance is ±.005
- Braided shield has 90% optical coverage

TurboFlex® Copper, Dual-Layer Duralectric™ D Insulation/Jacket, Microfilament Braided Shield, 2000 VAC • 961-155 Imperial

Table I: TurboFlex DC Resistance and Ampacity Ratings					
AWG Code	DC Resistance @ 20°C (Ohms / 1000 ft.)			Ampacity (Amps) 40°C Ambient	
	Nickel Copper	Tin Copper	Silver Copper	Nickel Copper	Tin/Silver Copper
T	10.718	10.7538	10.0747	16	14
R	4.5510	4.5930	4.2780	40	36
S	2.8450	2.8710	2.6740	59	54
A	1.8450	1.8620	1.7340	78	68
B	1.1570	1.1680	1.0880	107	90
C	.7188	.7252	.6755	142	124
D	.4551	.4593	.4278	205	165
E	.2979	.3006	.2800	278	220
F	.1876	.1893	.1763	381	293
G	.1178	.1188	.1107	532	399
H	.0938	.0946	.0882	591	467
I	.0738	.0745	.0694	708	546
J	.0588	.0594	.0553	830	629

Maximum ampacities are based on temperature rise to limits of the materials used in cable construction, based on single cable bundle in free air and at sea level pressure. Consult Glenair for more information.

Ampacity Ratings: Ambient Temperature Correction Factors	
Ambient Temp (°C)	For ambient temperatures other than 40°C (104°F), multiply the allowable ampacities from the table above by the appropriate factor below
41 – 50	0.97
51 – 60	0.94
61 – 70	0.90
71 – 80	0.87
81 – 90	0.83
91 – 100	0.79
101 – 120	0.71
121 – 140	0.61
141 – 160	0.50
161 – 180	0.35
181 – 200	----
201 – 255	----

MICROFILAMENT BRAIDED • COPPER CORE

TurboFlex® Copper, Dual-Layer Duraelectric™ D Insulation/Jacket, Microfilament Braided Shield, 1000 VAC • 961-157 Imperial

MICROFILAMENT BRAIDED • COPPER CORE

FEATURES

- Glenair microfilament braided shield (ArmorLite™ or AmberStrand) provides lightweight grounding.
- Black Duraelectric D insulation to protect the conductor, surrounded with a lightweight microfilament braided shield, with an outer jacket for overall cable protection.

How to Order TurboFlex®					
Sample Part Number	961-157	-T	-AM	-A	-2
Basic No.	TurboFlex with .016" Duraelectric D Jackets				
Conductor Material	-T = Tin/Copper (-65° - 150°C) -S = Silver/Copper (-65° - 200°C) -N = Nickel/Copper (-65° - 200°C)				
Braided Shield Material	-AM = AmberStrand -AR = ArmorLite -CF = ArmorLite CF				
Wire Size (See Table I)	T, R, S, A, B, C, D, E, F, G				
Outer Duraelectric D Jacket Color	See Table II				

AWG Code	AWG	Strand / Count / AWG	Cir Mil (nom)	Ø A in. (mm)	"B" Insulation Wall Thickness in. (mm)	"C" Shield Thickness in. (mm)	"D" Outer Jacket Wall Thickness in. (mm)	Ø E in. (mm)
T	20	42/36	1050	.037 (0.94)	.016 (0.41)	.008 (0.20)	.016 (0.41)	.177 (4.50)
R	16	7 X 15/36	2625	.063 (1.60)				.143 (3.63)
S	14	7 X 24/36	4200	.080 (2.03)				.160 (4.06)
A	12	7 X 37/36	6475	.099 (2.51)				.179 (4.55)
B	10	7 X 59/36	10325	.126 (3.20)				.206 (5.23)
C	8	7 X 95/36	16625	.159 (4.04)				.239 (6.07)
D	6	7 X 150/36	26250	.200 (5.08)				.280 (7.11)
E	4	7 X 7 X 34/36	41650	.271 (6.88)				.351 (8.92)
F	2	7 X 7 X 54/36	66150	.342 (8.69)	.422 (10.72)			
G	1/0	7 X 7 X 86/36	105350	.431 (10.95)	.511 (12.98)			

Shield Material	Conductor Material		
	Tin (-65°/+150°)	Silver (-65°/+200°)	Nickel (-65°/+200°)
AmberStrand (-80°/+220°)	-65° / +150°	-65° / +200°	-65° / +220°
ArmorLite (-80°/+260°)	-65° / +150°	-65° / +200°	-65° / +200°
ArmorLite CF (-80°/+400°)	-65° / +150°	-65° / +200°	-65° / +200°

Weatherproof, halogen free, flame resistant	
0	Black
1	Brown
2	Red
3	Orange
4	Yellow
5	Kelly Green
6	Blue
7	Violet
8	Gray
9	White

Consult factory for other specific colors

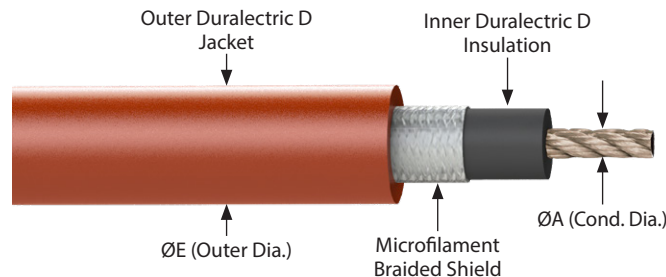

NOTES

1. Bend radius is 4X the outer diameter
2. Cable will be marked with "GLENAIR TURBOFLEX", wire gauge, part number, CAGE 06324.
3. Jacket thickness tolerance is ±.002
4. Braided shield has 90% optical coverage

TurboFlex® Copper, Dual-Layer Duralectric™ D Insulation/Jacket, Microfilament Braided Shield, 1000 VAC • 961-157 Imperial

Table I: TurboFlex DC Resistance and Ampacity Ratings

AWG Code	DC Resistance @ 20°C (Ohms / 1000 ft.)			Ampacity (Amps) 40°C Ambient	
	Nickel Copper	Tin Copper	Silver Copper	Nickel Copper	Tin/Silver Copper
T	10.718	10.7538	10.0747	16	14
R	4.5510	4.5930	4.2780	40	36
S	2.8450	2.8710	2.6740	59	54
A	1.8450	1.8620	1.7340	78	68
B	1.1570	1.1680	1.0880	107	90
C	.7188	.7252	.6755	142	124
D	.4551	.4593	.4278	205	165
E	.2979	.3006	.2800	278	220
F	.1876	.1893	.1763	381	293
G	.1178	.1188	.1107	532	399

Maximum ampacities are based on temperature rise to limits of the materials used in cable construction, based on single cable bundle in free air and at sea level pressure. Consult Glenair for more information.

Ampacity Ratings: Ambient Temperature Correction Factors

Ambient Temp (°C)	Correction Factor
41 – 50	0.97
51 – 60	0.94
61 – 70	0.90
71 – 80	0.87
81 – 90	0.83
91 – 100	0.79
101 – 120	0.71
121 – 140	0.61
141 – 160	0.50
161 – 180	0.35
181 – 200	----
201 – 255	----

For ambient temperatures other than 40°C (104°F), multiply the allowable ampacities from the table above by the appropriate factor below

MICROFILAMENT BRAIDED • COPPER CORE

TurboFlex® Copper Core, Duraelectric™ D Insulation and Fabric Overbraid, 2000-4500 VAC • 961-044 Imperial

ABRASION-RESISTANT • HIGH-TEMP • COPPER CORE

FEATURES

- Fabric overbraid provides abrasion and temperature protection. Choose the appropriate braid with the selection guide table at right.
- Voltage rating is dependent on insulation wall thickness, select per application requirements.

How to Order TurboFlex®	
Sample Part Number	961-044 -1 -C -G -2 -D -0
Basic No.	TurboFlex with Duraelectric D Insulation and fabric overbraid
Wall Thickness	-1 = .125" (4500 VAC) -2 = .093" (3500 VAC) -3 = .062" (3000 VAC) -4 = .032" (2000 VAC) -5 = .016"
Conductor Material	-T = Tin/Copper (-65° - 150°C) -S = Silver/Copper (-65° - 200°C) -N = Nickel/Copper (-65° - 200°C)
Wire Size (See Table I)	See Table I: (Conductor size availability depends on Insulation thickness) A, B, C, D, E, F, G, H, I, J, K, L, T, R, S
Duraelectric D Insulation Color	See Table II
Braid Material	See Braid Material and Color Selection Guide
Braid Color	See Braid Material and Color Selection Guide

Table I: Conductor Size Code (availability depends on Insulation thickness)

Conductor size (AWG)	Insulation Thickness in. (mm)				
	.125	.093	.062	.032	.016
20	N/A	N/A	N/A	T	T
16				R	R
14				S	S
12				A	A
10				B	B
8				C	C
6				D	D
4				E	E
2				F	F
1/0				G	G
2/0	H	H	H		
3/0	I	I	I		
4/0	J	J	J		
250 MCM	K	K	K		
450 MCM	L	L	L	N/A	

Table IV: Approximate Outer Diameter

Conductor size (AWG)	Insulation Thickness in. (mm)				
	.125	.093	.062	.032	.016
20	N/A	N/A	N/A	.16	.12
16				.18	.16
14				.20	.17
12				.28	.22
10				.31	.25
8				.40	.34
6				.44	.38
4				.51	.45
2				.58	.52
1/0				.74	.67
2/0	.79	.72	.66		
3/0	.85	.79	.73		
4/0	.92	.85	.79		
250 MCM	.97	.90			
450 MCM	1.20	1.13			

Table II: Duraelectric D Insulation Color

	Weatherproof, halogen free, flame resistant
0	Black
1	Brown
2	Red
3	Orange
4	Yellow
5	Kelly Green
6	Blue
7	Violet
8	Gray
9	White

Consult factory for other specific colors

Table III: Voltage Rating

Insulation Thickness	AC Voltage Rating, RMS
.125 (3.18)	4500
.093 (2.36)	3500
.062 (1.57)	3000
.032 (0.81)	2000
.016 (0.41)	1000

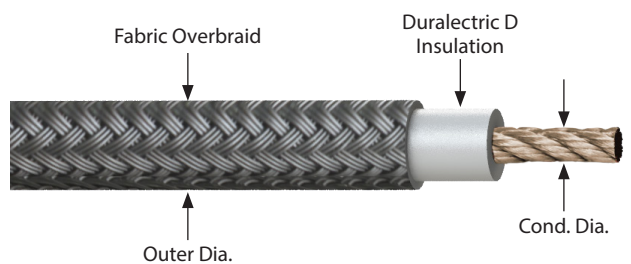

NOTES

- Cable will be tagged with complete part number

TurboFlex® Copper Core, Duraelectric™ D Insulation and Fabric Overbraid, 2000-4500 VAC • 961-044 Imperial

Braid Material and Color Selection Guide										
Principal Selection Criteria	General Duty / Abrasion Resistance					Economy		Temperature Tolerance	Fire Resistance	
Braid Code Material Construction	Z Monofilament FEP	P Monofilament PET, Type FR	H Monofilament Halar®	M Yarn, Nomex®	R Monofilament Ryton, Type R-7	D Yarn, Dacron®	Y Yarn, Nylon	K Monofilament PEEK	X Yarn, PTFE-Glass	V Yarn, Kevlar®
Color Code Options	C = Clear	B = Black W = White	B = Black W = White BW = Black w/ White Tracer WB = White w/ Black Tracer	B = Black R = Red OR = Orange GN = Green GY = Gray W = White TN = Desert Tan	N = Natural	B = Black	B = Black GY = Gray OD = Olive Drab	B = Black	BR = Brown N = Natural	B = Black N = Natural
Halogen-Free	NO		NO						NO	
Temperature Range	-55°C to +200°C	-55°C to +125°C	-65°C to +150°C	-55°C to +200°C	-65°C to +180°C	-62°C to +125°C	-20° to +170°	-65°C to +260°C	-204°C to +482°C	-73°C to +160°C
Tensile Strength (PSI) Yield	3300	50,000	7000	90,000	19,000	10,000	12,400	13,000	450,000	400,000
Elongation Percentage	50%	20%	15%	25%	40%	12%	90%	38%	5%	3.6%
Chemical Resistance	Excellent	Good	Excellent	Excellent	Excellent	Good	Excellent	Excellent	Excellent	Excellent
Abrasion Resistance	Good	Good	Excellent	Good	Excellent	Fair	Excellent	Excellent	Excellent	Good
Weight / Duty (specific gravity)	Heavy (2.17)	Medium (1.38)	Medium (1.68)	Medium (1.58)	Light (1.25)	Medium (1.38)	Light (1.14)	Light (1.3)	Heavy (2.5)	Medium (1.44)
Flammability	Very Low	Flammable, Self-Extinguishing	Very Low	Will Not Melt	Very Low	Flammable	Flammable	Very Low	Will Not Burn	Will Not Melt

Table V: Service Temperature Matrix (min/max in °C) Service temperature dependent on conductor and braid material selected				
Braid Code	Braid Material (and temperature range)	Conductor Material (and temperature range)		
		Tin Copper (-65/+150)	Silver Copper (-65/+200)	Nickel Copper (-65/+260)
D	Dacron (-62/+125)	(-65/+125)	(-65/+125)	(-65/+125)
H	Halar (-65/+150)	(-65/+150)	(-65/+150)	(-65/+150)
Y	Nylon (-20/+170)	(-20/+150)	(-20/+170)	(-20/+170)
M	Nomex (-55/+200)	(-55/+150)	(-55/+200)	(-55/+200)
P	Polyester Type FR (-55/+125)	(-55/+125)	(-55/+125)	(-55/+125)
Z	FEP Teflon (-55/+200)	(-55/+150)	(-55/+200)	(-55/+200)
R	Ryton Type R-7 (-65/+180)	(-65/+150)	(-65/+180)	(-65/+180)
K	PEEK (-65/+260)	(-65/+150)	(-65/+200)	(-65/+260)
V	Kevlar (-73/+160)	(-65/+150)	(-65/+160)	(-65/+160)
X	PTFE-Glass (-204/+482)	(-65/+150)	(-65/+200)	(-65/+260)

DuPont™ Nomex® and Kevlar® are trademarks or registered trademarks of E.I. duPont de Nemours and Company. All other marks and brands are registered to, or possessions of, their respective owners and/or companies.

ABRASION-RESISTANT • HIGH-TEMP • COPPER CORE

TurboFlex® Copper, Triple-Layer Duraelectric™ D/C (HPHV) Insulation, ArmorLite Shield, and Duraelectric™ L Jacket • 961-113 Imperial

HIGH-VOLTAGE / HIGH-POWER

FEATURES

- High-voltage / high-power configuration: Triple-layer primary insulation construction (Duraelectric C, Duraelectric D, Duraelectric C) for high voltage stress control with ArmorLite shield and Duraelectric Light outer jacket for optimal power-to-weight ratio
- Peel-off outer Duraelectric C semiconductive layer for highly consistent and reliable tool-free terminations
- Partial Discharge Inception Voltage (PDIV, > 5 pC) = 4.4 kVAC
- Partial Discharge Extinction Voltage (PDEV, < 5 pC) = 3.8 kVAC
- For PDIV/EV altitude and bend radius derating, see GT-22-274

How to Order TurboFlex®					
Sample Part Number	961-113	-N	-G	-5	P
Basic No.	TurboFlex with Duraelectric D/C Insulation and L Jacket				
Conductor / Braided Shield Material	-S = Silver/Copper (-65° - 200°C) -N = Nickel/Copper (-65° - 200°C)				
Wire Size (See Table I)	C, D, E, F, G, H, I, J				
Duraelectric L Jacket Color (inner and outer)	See Table II				
Peel-Off Semiconductive Layer	P = with peel-off semiconductive layer				

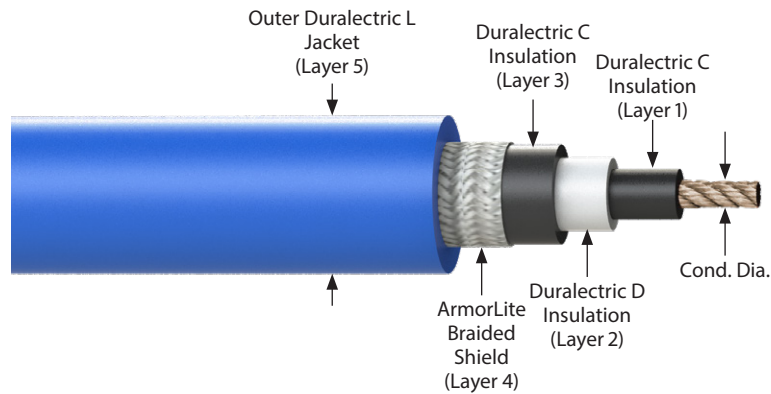

Table II: Duraelectric™ Jacket Color

Weatherproof, halogen free, flame resistant

0	Black
1	Brown
2	Red
3	Orange
4	Yellow
5	Kelly Green
6	Blue
7	Violet
8	Gray
9	White
OG	Dark Olive Green
DT	Desert Tan

Consult factory for other specific colors

TurboFlex 961-113 Layer Construction	
Layer	Material / Plating
Conductor	TurboFlex copper conductor plated per P/N development
1	Conductive silicone, black (.025" thick)
2	Duraelectric, color per P/N development (.025" thick)
3	Conductive silicone, black (.030" Thick)
4	ArmorLite shield, plating per P/N development. 95% coverage
5	Duraelectric Light, color per P/N development (.060" thick)

NOTES

1. Cable will be marked with "GLENAIR TURBOFLEX", wire gauge, part number, CAGE 06324.
2. Bend radius is 6X the outer diameter, see GT-22-274 for deratings
3. Overall diameter (Layer 5) tolerance is ±.020" (.51)



TurboFlex® Copper, Triple-Layer Duralectric™ D/C (HPHV) Insulation, ArmorLite Shield, and Duralectric™ L Jacket • 961-113 Imperial

Table I: TurboFlex Wire Size and Dimensions

AWG Code	AWG	Strand / Count / AWG	Cir Mil (nom)	Weight lbs/1000 ft. (nom.)	Conductor Ø in. (mm)	Layer 1 Ø (nom) in. (mm)	Layer 2 Ø (nom) in. (mm)	Layer 3 Ø (nom) in. (mm)	Layer 4 Ø (nom) in. (mm)	Layer 5 Ø (nom) in. (mm)
C	8	7 X 95/36	16625	144.20	.159 (4.04)	.209 (5.31)	.259 (6.58)	.319 (8.10)	.335 (8.51)	.455 (11.56)
D	6	7 X 150/36	26250	188.25	.200 (5.08)	.250 (6.35)	.300 (7.62)	.360 (9.14)	.376 (9.55)	.496 (12.60)
E	4	7 X 7 X 34/36	41650	266.31	.271 (6.88)	.321 (8.15)	.371 (9.42)	.431 (10.95)	.447 (11.35)	.567 (14.40)
F	2	7 X 7 X 54/36	66150	367.47	.342 (8.69)	.392 (9.96)	.442 (11.23)	.502 (12.75)	.518 (13.16)	.638 (16.21)
G	1/0	7 X 7 X 86/36	105350	522.88	.431 (10.95)	.481 (12.22)	.531 (13.49)	.591 (15.01)	.607 (15.42)	.727 (18.47)
H	2/0	7 X 7 X 108/36	132300	626.40	.483 (12.27)	.533 (13.54)	.583 (14.81)	.643 (16.33)	.659 (16.74)	.779 (19.79)
I	3/0	19 X 7 X 51/36	169575	774.66	.547 (13.89)	.597 (15.16)	.647 (16.43)	.707 (17.96)	.723 (18.36)	.843 (21.41)
J	4/0	19 X 7 X 64/36	212800	963.84	.613 (15.57)	.663 (16.84)	.713 (18.11)	.773 (19.63)	.789 (20.04)	.909 (23.09)

DC Resistance and Ampacity Ratings*

AWG Code	DC Resistance @ 20°C (Ohms / 1000 ft.)			Ampacity (Amps) 40°C Ambient	
	Nickel Copper	Tin Copper	Silver Copper	Nickel Copper	Tin/Silver Copper
C	.7188	.7252	.6755	142	124
D	.4551	.4593	.4278	205	165
E	.2979	.3006	.2800	278	220
F	.1876	.1893	.1763	381	293
G	.1178	.1188	.1107	532	399
H	.0938	.0946	.0882	591	467
I	.0738	.0745	.0694	708	546
J	.0588	.0594	.0553	830	629

*Based on NEC Table 310.19
Maximum ampacities are based on temperature rise to limits of the materials used in cable construction, based on single cable bundle in free air and at sea level pressure. Consult Glenair for more information.

Electrical Specifications

Property	Typical Result	Test Method
Partial Discharge Initiation Voltage (PDIV) at 5 pC	4.4 kVAC	EN3475-307
Partial Discharge Extinction Voltage (PDEV) at 5 pC	3.8 kVAC	EN3475-307
Spark (Impulse)	10 kV	ASTM D3032

HIGH-VOLTAGE / HIGH-POWER

TurboFlex® Copper Core, Lightweight Duraelectric™ L Insulation, 1250 VAC • 961-041 Imperial

LIGHTWEIGHT INSULATION

FEATURES

- TurboFlex with weight-saving Duraelectric L (light) insulation: 30% lighter than original Duraelectric, best abrasion resistance, same great fluid/fire resistance as original Duraelectric

How to Order TurboFlex®				
Sample Part Number	961-041	-T	-A	-2
Basic No.	TurboFlex with .025" Duraelectric L (light) Insulation			
Conductor Material	-T = Tin/Copper (-65° - 150°C) -S = Silver/Copper (-65° - 200°C) -N = Nickel/Copper (-65° - 200°C)			
Wire Size (See Table I)	R, S, A, B, C, D, E, F, G			
Duraelectric L Insulation Color	See Table II			

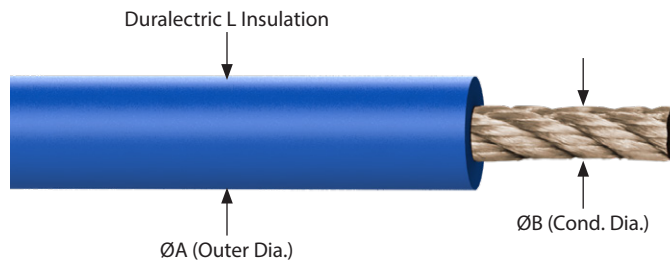

Table I: TurboFlex Wire Size, Dimensions, DC Resistance and Ampacity Ratings

AWG Code	AWG	Strand / Count / AWG	Cir Mil (nom)	Ø B in. (mm)	DC Resistance @ 20°C (Ohms / 1000 ft.)			Typical Ampacity (Amps) 40°C Ambient	
					Nickel Copper	Tin Copper	Silver Copper	Nickel/Silver Copper	Tin Copper
R	16	7 X 15/36	2625	.063 (1.60)	4.5510	4.5930	4.2780	15-35	15-30
S	14	7 X 24/36	4200	.080 (2.03)	2.8450	2.8710	2.6740	20-50	20-45
A	12	7 X 37/36	6475	.099 (2.51)	1.8450	1.8620	1.7340	30-70	30-60
B	10	7 X 59/36	10325	.126 (3.20)	1.1570	1.1680	1.0880	40-90	40-75
C	8	7 X 95/36	16625	.159 (4.04)	.7188	.7252	.6755	55-135	55-115
D	6	7 X 150/36	26250	.200 (5.08)	.4551	.4593	.4278	75-185	75-155
E	4	7 X 7 X 34/36	41650	.271 (6.88)	.2979	.3006	.2800	105-250	105-215
F	2	7 X 7 X 54/36	66150	.342 (8.69)	.1876	.1893	.1763	145-345	145-290
G	1/0	7 X 7 X 86/36	105350	.431 (10.95)	.1178	.1188	.1107	195-465	195-395

Maximum ampacities are based on temperature rise to limits of the materials used in cable construction, based on single cable bundle in free air and at sea level pressure. Consult Glenair for more information.

Table II: Duraelectric L Insulation Color

Weatherproof, halogen free, flame resistant	
0	Black
1	Brown
2	Red
3	Orange
4	Yellow
5	Kelly Green
6	Blue
7	Violet
8	Gray
9	White

Consult factory for other specific colors

961-041 Wire Weight and Outer Diameter

AWG Code	Weight lbs/1000 ft. (nom.)	Ø A in. (mm)	Insulation wall thickness in. (mm)
R	11.60	.113 (2.87)	.025 (.64)
S	17.30	.130 (2.54)	
A	25.40	.149 (3.78)	
B	38.90	.176 (4.47)	
C	60.70	.209 (5.31)	
D	93.60	.250 (6.35)	
E	151.70	.321 (8.15)	
F	237.40	.392 (9.96)	
G	373.70	.481 (12.22)	

NOTES

- Bend radius is 3X the outer diameter
- Cable will be marked with "GLENAIR TURBOFLEX LIGHT", wire gauge, part number, CAGE 06324.
- Insulation thickness tolerance is ±.005

TurboFlex® Copper Core, Duraelectric™ K Insulation, 1000–3000 VAC, -110 °C – +200 °C • 961-033 Imperial

FEATURES

- TurboFlex with Duraelectric K insulation for low-temperature tolerance and gamma radiation resistance
- Ultra Low Temp Flexibility to -110°C (163 Kelvin)
- Bend Radius is 3X the outer diameter
- Perfect for spacecraft, satellites, nuclear environments

How to Order TurboFlex®				
Sample Part Number	961-033	-T	-A	-2
Basic No.	TurboFlex with Duraelectric K Insulation			
Conductor Material	-T = Tin/Copper (-110° - 150°C) -N = Nickel/Copper (-110° - 200°C)			
Wire Size (See Table I)	T, R, S, A, B, C, D, E, F, G			
Duraelectric L Insulation Color	See Table II			

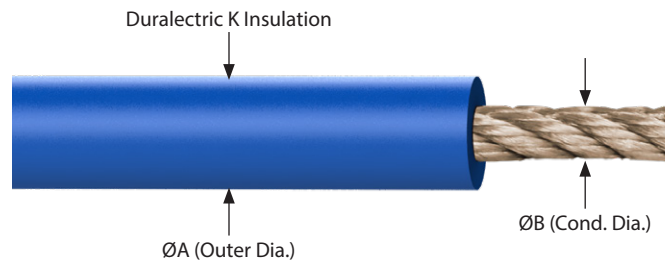

Table I: TurboFlex Wire Size, Dimensions, DC Resistance and Ampacity Ratings

AWG Code	AWG	Strand / Count / AWG	Cir Mil (nom)	Ø B in. (mm)	DC Resistance @ 20°C (Ohms / 1000 ft.)			Ampacity (Amps) 40°C Ambient	
					Nickel Copper	Tin Copper	Silver Copper	Nickel Copper	Tin/Silver Copper
T	20	42/36	1050	.037 (0.94)	10.7178	10.7538	10.0747	16	14
R	16	7 X 15/36	2625	.063 (1.60)	4.5510	4.5930	4.2780	40	36
S	14	7 X 24/36	4200	.080 (2.03)	2.8450	2.8710	2.6740	59	54
A	12	7 X 37/36	6475	.099 (2.51)	1.8450	1.8620	1.7340	78	68
B	10	7 X 59/36	10325	.126 (3.20)	1.1570	1.1680	1.0880	107	90
C	8	7 X 95/36	16625	.159 (4.04)	.7188	.7252	.6755	142	124
D	6	7 X 150/36	26250	.200 (5.08)	.4551	.4593	.4278	205	165
E	4	7 X 7 X 34/36	41650	.271 (6.88)	.2979	.3006	.2800	278	220
F	2	7 X 7 X 54/36	66150	.342 (8.69)	.1876	.1893	.1763	381	293
G	1/0	7 X 7 X 86/36	105350	.431 (10.95)	.1178	.1188	.1107	532	399

Maximum ampacities are based on temperature rise to limits of the materials used in cable construction, based on single cable bundle in free air and at sea level pressure. Consult Glenair for more information.

Table II: Duraelectric K Insulation Color	
Weatherproof, halogen free, flame resistant	
0	Black
1	Brown
2	Red
3	Orange
4	Yellow
5	Kelly Green
6	Blue
7	Violet
8	Gray
9	White

Consult factory for other specific colors

961-033 Wire Weight and Outer Diameter			
AWG Code	Weight lbs/1000 ft. (nom.)	Ø A in. (mm)	Insulation wall thickness in. (mm) and VAC
T	5.00	.069 (1.75)	.016 (0.41)
R	11.10	.095 (2.41)	1000 VAC
S	20.70	.144 (3.66)	.032 (0.81) 2000 VAC
A	29.40	.163 (4.14)	
B	43.90	.190 (4.83)	
C	66.90	.223 (5.66)	
D	101.40	.264 (6.71)	
E	162.40	.335 (8.51)	.062 (1.57) 3000 VAC
F	275.90	.466 (11.84)	
G	422.00	.555 (14.10)	

Ambient Temperature Correction Factors	
Ambient Temp (°C)	For ambient temperatures other than 40°C (104°F), multiply the ampacity by the appropriate factor below
41 – 50	0.97
51 – 60	0.94
61 – 70	0.90
71 – 80	0.87
81 – 90	0.83
91 – 100	0.79
101 – 120	0.71
121 – 140	0.61
141 – 160	0.50
161 – 180	0.35

NOTES

1. Bend radius is 3X the outer diameter
2. Cable will be marked with "GLENAIR TURBOFLEX K", wire gauge, part number, CAGE 06324.
3. Insulation thickness tolerance is ±.002 for .016" thickness, ±.005 for .032" thickness, ±10% for .125" thickness

LOW-TEMP / RAD-RESISTANT

TurboFlex® Copper Core, Dual Duraelectric™ D/F Insulation/Jacket, 1000 VAC • 961-139 Imperial

SWAMP-ZONE / FUEL-RESISTANT

FEATURES

- TurboFlex with Duraelectric D insulation and Duraelectric F jacket for fire resistance and outstanding immersion performance in fuel and harsh fluids
- Resistant to jet fuels and oils and flexible to -65°C
- Suited for harsh environments that require low temp flex such as aircraft and ground vehicle fuel systems

How to Order TurboFlex®					
Sample Part Number	961-139	-N	-A	-2	-6
Basic No.	TurboFlex with Duraelectric D Insulation (.016") and Duraelectric F jacket (.016")				
Conductor Material	-T = Tin/Copper (-65° - 150°C) -S = Silver/Copper (-65° - 200°C) -N = Nickel/Copper (-65° - 200°C)				
Wire Size (See Table I)	T, R, S, A, B, C, D, E, F, G				
Duraelectric D Insulation Color	See Table II				
Duraelectric F Jacket	Blue color				

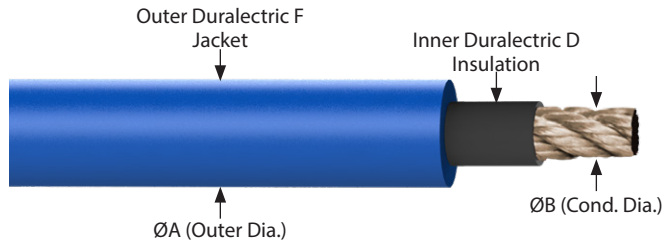

Table I: TurboFlex Wire Size, Dimensions, DC Resistance and Ampacity Ratings

AWG Code	AWG	Strand / Count / AWG	Cir Mil (nom)	Ø B in. (mm)	DC Resistance @ 20°C (Ohms / 1000 ft.)			Ampacity (A mps) 40°C Ambient	
					Nickel Copper	Tin Copper	Silver Copper	Nickel Copper	Tin/Silver Copper
T	20	42/36	1050	.037 (0.94)	10.7178	10.7538	10.0747	16	14
R	16	7 X 15/36	2625	.063 (1.60)	4.5510	4.5930	4.2780	40	36
S	14	7 X 24/36	4200	.080 (2.03)	2.8450	2.8710	2.6740	59	54
A	12	7 X 37/36	6475	.099 (2.51)	1.8450	1.8620	1.7340	78	68
B	10	7 X 59/36	10325	.126 (3.20)	1.1570	1.1680	1.0880	107	90
C	8	7 X 95/36	16625	.159 (4.04)	.7188	.7252	.6755	142	124
D	6	7 X 150/36	26250	.200 (5.08)	.4551	.4593	.4278	205	165
E	4	7 X 7 X 34/36	41650	.271 (6.88)	.2979	.3006	.2800	278	220
F	2	7 X 7 X 54/36	66150	.342 (8.69)	.1876	.1893	.1763	381	293
G	1/0	7 X 7 X 86/36	105350	.431 (10.95)	.1178	.1188	.1107	532	399

Maximum ampacities are based on temperature rise to limits of the materials used in cable construction, based on single cable bundle in free air and at sea level pressure. Consult Glenair for more information.

Table II: Duraelectric™ F Jacket Color

Weatherproof, halogen free, flame resistant	
0	Black
1	Brown
2	Red
3	Orange
4	Yellow
5	Kelly Green
6	Blue
7	Violet
8	Gray
9	White

Consult factory for other specific colors

961-139 Wire Weight and Outer Diameter

AWG Code	Weight lbs/1000 ft. (nom.)	Ø A in. (mm)	Total Jacket wall thickness in. (mm)
T	7.90	.101 (2.57)	.032 (0.81)
R	14.90	.127 (3.23)	
S	21.30	.144 (3.66)	
A	30.10	.163 (4.14)	
B	44.70	.190 (4.83)	
C	67.80	.223 (5.66)	
D	102.50	.264 (6.71)	
E	163.90	.335 (8.51)	
F	253.40	.406 (10.31)	
G	394.90	.495 (12.57)	

NOTES

1. Bend radius is 3X the outer diameter
2. Cable will be marked with "GLENAIR TURBOFLEX", wire gauge, part number, CAGE 06324
3. Insulation thickness tolerance is ±.002 and outer jacket thickness tolerance is ±.005

TurboFlex® Copper Core, UL recognized, Duraelectric™ D Insulation, 1000 VAC • 961-065 Imperial

UL-RECOGNIZED

Glenair TurboFlex 961-065 is UL recognized



meets UL 758 Style 3644

How to Order TurboFlex®				
Sample Part Number	961-065	-N	-D	-2
Basic No.	TurboFlex, UL recognized, with Duraelectric D Insulation (.035" - .100")			
Conductor Material	-N = Nickel/Copper (-65°C – 200°C)			
Wire Size (See Table I)	T, R, S, A, B, C, D, E, F, G, H, I, J, K, L			
Duraelectric D Insulation Color	See Table II			

Table I: TurboFlex Wire Size, Dimensions, DC Resistance and Ampacity Ratings

AWG Code	AWG	Strand / Count / AWG	Cir Mil (nom)	Ø B in. (mm)	DC Resistance @ 20°C (Ohms / 1000 ft.)		Ampacity (Amps) 40°C Ambient (per NEC Table 310.19)
					Nickel Copper	Nickel Copper	
T	20	42-36	1050	.037 (.94)	10.7178	16	
R	16	7 X 15/36	2625	.063 (1.60)	4.5510	40	
S	14	7 X 24/36	4200	.080 (2.03)	2.8450	59	
A	12	7 X 37/36	6475	.099 (2.51)	1.8450	78	
B	10	7 X 59/36	10325	.126 (3.20)	1.1570	107	
C	8	7 X 95/36	16625	.159 (4.04)	.7188	142	
D	6	7 X 150/36	26250	.200 (5.08)	.4551	205	
E	4	7 X 7 X 34/36	41650	.271 (6.88)	.2979	278	
F	2	7 X 7 X 54/36	66150	.342 (8.69)	.1876	381	
G	1/0	7 X 7 X 86/36	105350	.431 (10.95)	.1178	532	
H	2/0	7 X 7 X 108/36	132300	.483 (12.27)	.0938	591	
I	3/0	19 X 7 X 51/36	169575	.547 (13.89)	.0738	708	
J	4/0	19 X 7 X 64/36	212800	.613 (15.57)	.0588	830	
K	250 MCM	19 X 7 X 75/36	249375	.663 (16.84)	.0502	910	
L	450 MCM	19 X 7 X 135/36	448875	.890 (22.61)	.0278	1320	

Maximum ampacities are based on temperature rise to limits of the materials used in cable construction, based on single cable bundle in free air and at sea level pressure. Consult Glenair for more information.

Table II: Duraelectric D Insulation Color	
Weatherproof, halogen free, flame resistant	
0	Black
1	Brown
2	Red
3	Orange
4	Yellow
5	Kelly Green
6	Blue
7	Violet
8	Gray
9	White
Consult factory for other specific colors	

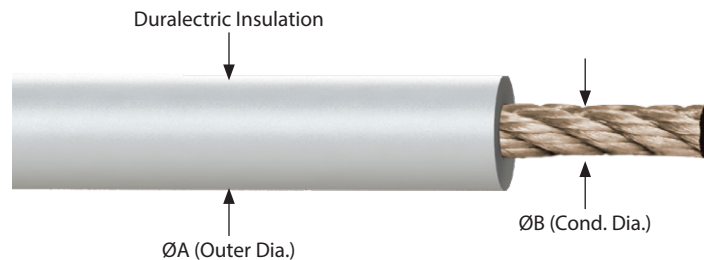

NOTES

- Bend radius is 3X the outer diameter
- Cable will be marked with "GLENAIR TURBOFLEX", wire gauge, part number, CAGE 06324, UL 758 AWM 3644, 1000VAC, 200°C.
- Insulation thickness tolerance is ±.005 for .035" thickness, and ±10% for all other sizes.

TurboFlex® Copper Core, UL recognized, Duralectric™ D Insulation, 1000 VAC • 961-065 Imperial

UL-RECOGNIZED

961-004 Wire Weight and Outer Diameter			
AWG Code	Weight lbs/1000 ft. (nom.)	Ø A in. (mm)	Insulation wall thickness in. (mm)
T	8.1	.107 (2.72)	.035 (.89)
R	15.2	.133 (3.38)	
S	21.5	.150 (3.81)	
A	30.3	.169 (4.29)	
B	50.8	.196 (4.98)	
C	82.6	.259 (6.58)	.050 (1.27)
D	119.7	.330 (8.38)	.065 (1.65)
E	185.7	.401 (10.19)	
F	278.6	.472 (11.99)	
G	446.8	.601 (15.27)	.085 (2.16)
H	548.4	.653 (16.59)	
I	693.1	.717 (18.21)	
J	854.7	.783 (19.89)	
K	1014.3	.863 (21.92)	.100 (2.54)
L	1754.2	1.090 (27.69)	

Ambient Temperature Correction Factors	
Ambient Temp (°C)	For ambient temperatures other than 40°C (104°F), multiply the ampacity by the appropriate factor below
41 – 50	0.97
51 – 60	0.94
61 – 70	0.90
71 – 80	0.87
81 – 90	0.83
91 – 100	0.79
101 – 120	0.71
121 – 140	0.61
141 – 160	0.50
161 – 180	0.35
181 – 200	----
201 – 225	----

961-065 UL recognized TurboFlex environmental performance	
Temperature rating	Duralectric D: -65°C to 200°C
Halogen free	per IEC 60614-1
Accelerated weathering and simulated solar radiation at ground level	per IEC 60068-2-5; 56 Days exposure, suitable for greater than 50 years of service in direct sunlight
Flame resistant	per IEC 60614-1
Flame resistant	per UL 1685, section 12 (FT4/IEEE120), vertical-tray fire-propagation and smoke release test
Flame resistant	per FAR 25.853 (A) amendment 25-116, appendix F part I (A) (1) (i), 60 second vertical burn test
Limiting oxygen index	45 per ISO 4589-2:1999
Low smoke	per NES 711, smoke density of 11.75
Smoke density	class F1 per NF F 16-101 IAW DIN EN 60695-2-11:2011
Low smoke toxicity	per NES 713, tested value of 1.9
Fungus rating	0 per MIL-STD-810g method 508.5, Does not support fungal growth
Tear Strength	ASTM D624, die B, 150 pounds per inch minimum on Insulation material
Low outgassing	per ASTM e595 after post curing, TML .06%, CVCM .006%, WVR .02%
Resistant to fluids	per MIL-STD-810F, method 504: JP-8 per MIL-DTL-83133 (NATO type 34) MIL-H-5606 hydraulic fluid MIL-PRF-23699 lubricating oil MIL-C-85570 cleaner TT-I-735 Isopropyl alcohol AMS 1432 potassium acetate deicing/anti-icing fluid MIL-C-87252 coolant Amerex AFF fire extinguishing foam

**TurboFlex® Copper Core, Duralectric™ D jacket, 3000 VAC
 3-phase symmetric with drain wire • 960-3300 Imperial**

3-PHASE POWER

FEATURES

- 3-phase symmetric power cable with segmented ground drain wires for Variable Frequency Drive applications
- Bend Radius is 4X the outer diameter
- Optional high-temperature tolerant Nomex® braid, -65° to +240°C rated

How to Order TurboFlex®				
Sample Part Number	960-3300	-N	-16	-B
Basic No.	TurboFlex VFD 3-phase symmetric with drain wire			
Conductor Material	-N = Nickel/Copper (-65° - 200°C)			
Wire Size AWG (See Table I)	16, 12, 8, 4, 1/0			
Braid option	-B = with abrasion-resistant, high-temperature tolerant Nomex® braid Omit for none			

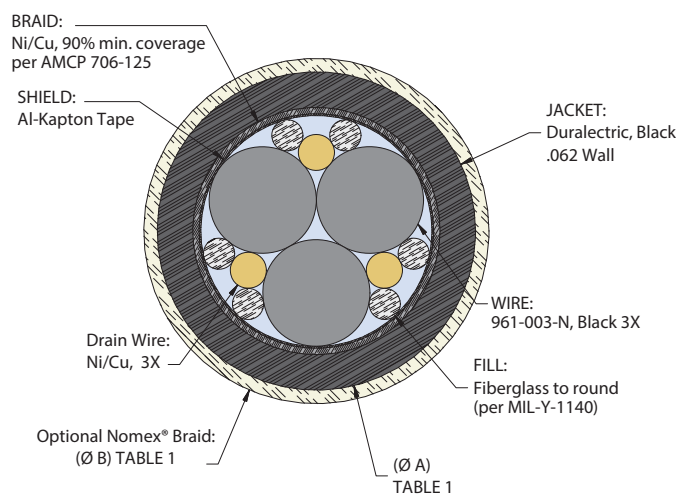
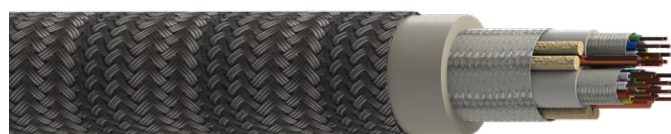

AWG	ØA in. (mm)	Drain Wire AWG	Braid Wire AWG	Ø B in. (mm)
16	.554 (14.07)	3X 16	34	.602 (15.29)
12	.631 (16.03)	N/A	34	.679 (17.25)
8	.760 (19.30)	3X 16	32	.808 (20.52)
4	1.001 (25.43)	3X 16	32	1.049 (26.64)
1/0	1.345 (34.16)	3X 12	30	1.393 (35.38)

NOTES

1. Voltage rating 3000VAC
2. Min. bend radius 4X OD
3. Optional braid: special purpose high temp, Nomex® braid, (-65°C to +240°C, braid rating only)

**TurboFlex® Copper Core, Duralectric™ D jacket, 3000 VAC
3-phase with full-size ground • 960-3301 Imperial**

3-PHASE POWER

FEATURES

- 3-phase unbalanced power cable with full-size ground for Variable Frequency Drive applications
- Bend Radius is 4X the outer diameter
- Optional high-temperature tolerant Nomex® braid, -65° to +240°C rated

How to Order TurboFlex®				
Sample Part Number	960-3301	-N	-16	-B
Basic No.	TurboFlex VFD 3-phase unbalanced with full-size ground			
Conductor Material	-N = Nickel/Copper (-65° - 200°C)			
Wire Size AWG (See Table I)	16, 12, 8, 4, 1/0			
Braid option	-B = with abrasion-resistant, high-temperature tolerant Nomex® braid Omit for none			

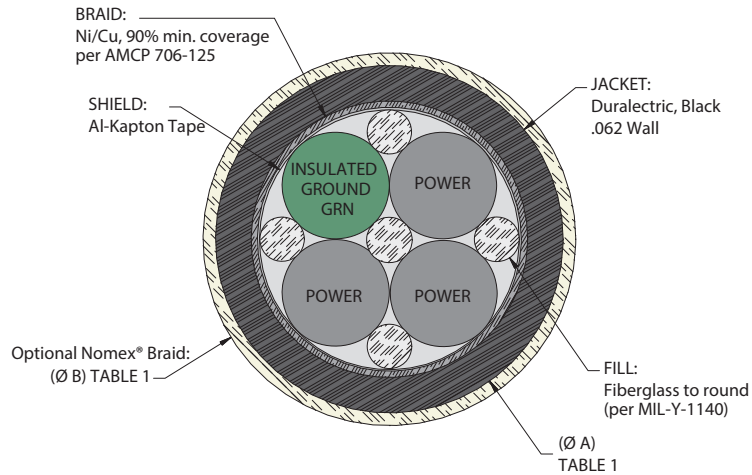

AWG	ØA in. (mm)	Braid Wire AWG	Ø B in. (mm)
16	.603 (15.32)	34	.651 (16.54)
12	.689 (17.50)	34	.737 (18.72)
8	.834 (21.18)	32	.882 (22.40)
4	1.104 (28.04)	32	1.152 (29.26)
1/0	1.409 (35.79)	30	1.457 (37.01)

NOTES

1. Voltage rating 3000VAC
2. Min. bend radius 4X OD
3. Optional braid: special purpose high temp, Nomex® braid, (-65°C to +240°C, braid rating only)

**TurboFlex® Copper Core, Duraelectric™ D jacket, 3000 VAC
3-phase with full-size ground and signal • 960-3302 Imperial**

3-PHASE POWER

FEATURES

- 3-phase unbalanced power cable with full size ground and signal cable for Variable Frequency Drive applications
- Bend Radius is 4X the outer diameter
- Optional high-temperature tolerant Nomex® braid, -65° to +240°C rated

How to Order TurboFlex®				
Sample Part Number	960-3302	-N	-16	-B
Basic No.	TurboFlex VFD 3-phase unbalanced with full-size ground and signal wire			
Conductor Material	-N = Nickel/Copper (-65° - 200°C)			
Wire Size AWG (See Table I)	16, 12, 8, 4, 1/0			
Braid option	-B = with abrasion-resistant, high-temperature tolerant Nomex® braid Omit for none			

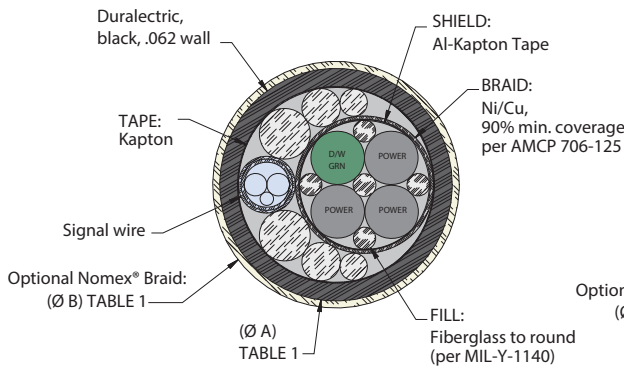
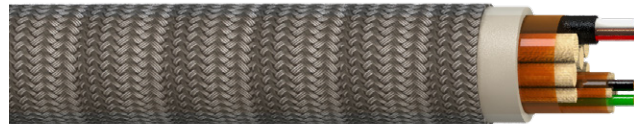

Figure 1
16, 12, and 8 gauge wire

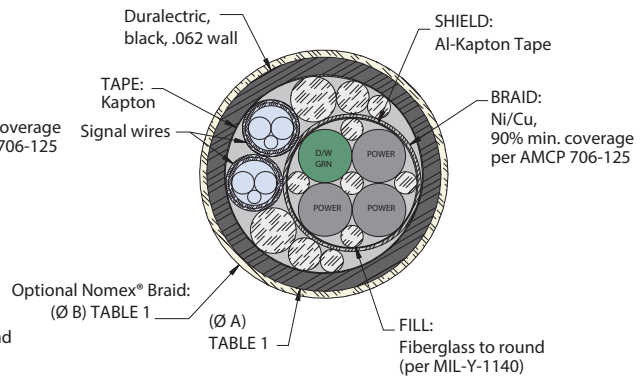

Figure 2
4 and 1/0 gauge wire

Table I: Wire Size / Dimensions						
AWG	Figure	ØA in. (mm)	Signal Wire AWG	Drain Wire AWG	Braid Wire AWG	Ø B in. (mm)
16	1	.811 (20.60)	16	16	34	.859 (21.82)
12	1	.895 (22.73)			34	.943 (23.95)
8	1	1.040 (26.42)			32	1.088 (27.64)
4	2	1.323 (33.60)			32	1.371 (34.82)
1/0	2	1.699 (43.15)			30	1.747 (44.37)

NOTES

1. Voltage rating 3000VAC
2. Min. bend radius 4X OD
3. Optional braid: special purpose high temp, Nomex® braid, (-65°C to +240°C, braid rating only)

TurboFlex® Aluminum Core, Duralectric™ D Insulation, 3500 VAC, 961-165 Imperial

GENERAL-DUTY • ALUMINUM CORE

FEATURES

- For weight savings: all the benefits of TurboFlex wire and Duralectric D insulation with lightweight aluminum core conductor

How to Order TurboFlex®					
Sample Part Number	961	-165	-A	-H	-2
Basic No.	TurboFlex with Duralectric D Insulation				
Wall Thickness	-165 = .093"				
Conductor Material	-A = Aluminum (-65 – 200°C)				
Wire Size (See Table I)	R, S, A, B, C, D, E, F, G, H, I, J, K, L				
Duralectric D Insulation Color	See Table II				

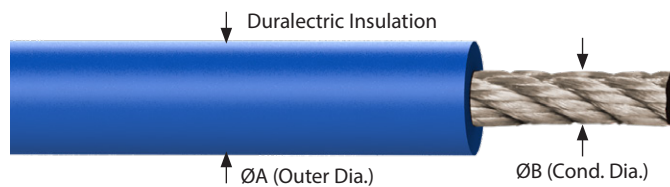

AWG Code	AWG	Strand / Count / AWG	Cir Mil (nom)	Ø B in. (mm)	DC Resistance @ 20°C (Ohms/1000 ft.)	Ampacity (Amps) 40°C Ambient
R	16	7 X 15/36	2625	.063 (1.60)	6.85	27
S	14	7 X 24/36	4200	.080 (2.03)	4.26	36
A	12	7 X 37/36	6475	.099 (2.51)	2.80	47
B	10	7 X 59/36	10325	.126 (3.20)	1.69	63
C	8	7 X 95/36	16625	.159 (4.04)	1.07	83
D	6	7 X 150/36	26250	.200 (5.08)	0.67	112
E	4	7 X 7 X 34/36	41650	.271 (6.88)	0.42	148
F	2	7 X 7 X 54/36	66150	.342 (8.69)	0.26	198
G	1/0	7 X 7 X 86/36	105350	.431 (10.95)	0.16	263
H	2/0	7 X 7 X 108/36	133000	.483 (12.27)	0.13	305
I	3/0	19 X 7 X 51/36	169575	.547 (13.89)	0.10	351
J	4/0	19 X 7 X 64/36	212800	.613 (15.57)	0.08	411
K	250MCM	19 X 7 X 75/36	249375	.663	0.07	446
L	450MCM	19 X 7 X 50/36	451250	.890	0.04	642

Maximum ampacities are based on temperature rise to limits of the materials used in cable construction, based on single cable bundle in free air and at sea level pressure. Consult Glenair for more information.

Ambient Temp (°C)	Correction Factor
For ambient temperatures other than 40°C (104°F), multiply the allowable ampacities from the table above by the appropriate factor below	
41 – 50	0.97
51 – 60	0.94
61 – 70	0.90
71 – 80	0.87
81 – 90	0.83
91 – 100	0.79
101 – 120	0.71
121 – 140	0.61
141 – 160	0.50
161 – 180	0.35
181 – 200	----
201 – 255	----

Weatherproof, halogen free, flame resistant	
0	Black
1	Brown
2	Red
3	Orange
4	Yellow
5	Kelly Green
6	Blue
7	Violet
8	Gray
9	White

Consult factory for other specific colors

AWG Code	Weight lbs/1000 ft. (nom.)	Ø A in. (mm)	Insulation wall thickness in. (mm)
R	29.7	.249	.062 (1.57)
S	34.3	.266	
A	39.9	.285	
B	48.5	.312	
C	60.7	.345	
D	77.7	.386	
E	105.8	.457	
F	143.2	.528	
G	198.8	.617	
H	236.3	.669	
I	284.9	.733	
J	340.7	.799	
K	387.0	.849	
L	633.5	1.076	

NOTES

- Bend radius is 3X the outer diameter
- Cable will be marked with "GLENAIR TURBOFLEX", wire gauge, part number, CAGE 06324.
- Insulation thickness tolerance is ±10%

TurboFlex® Aluminum Core, Duraelectric™ D Insulation, 3000 VAC, 961-062 Imperial

GENERAL-DUTY • ALUMINUM CORE

FEATURES

- For weight savings: all the benefits of TurboFlex wire and Duraelectric D insulation with lightweight aluminum core conductor

How to Order TurboFlex®					
Sample Part Number	961	-062	-A	-H	-2
Basic No.	TurboFlex with Duraelectric D Insulation				
Wall Thickness	-062 = .062"				
Conductor Material	-A = Aluminum (-65 – 200°C)				
Wire Size (See Table I)	R, S, A, B, C, D, E, F, G, H, I, J				
Duraelectric D Insulation Color	See Table II				

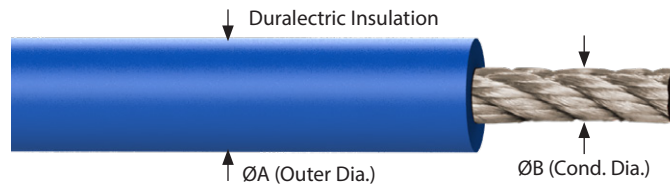

AWG Code	AWG	Strand / Count / AWG	Cir Mil (nom)	Ø B in. (mm)	DC Resistance @ 20°C (Ohms/1000 ft.)	Ampacity (Amps) 40°C Ambient
R	16	7 X 15/36	2625	.063 (1.60)	6.85	27
S	14	7 X 24/36	4200	.080 (2.03)	4.26	36
A	12	7 X 37/36	6475	.099 (2.51)	2.80	47
B	10	7 X 59/36	10325	.126 (3.20)	1.69	63
C	8	7 X 95/36	16625	.159 (4.04)	1.07	83
D	6	7 X 150/36	26250	.200 (5.08)	0.67	112
E	4	7 X 7 X 34/36	41650	.271 (6.88)	0.42	148
F	2	7 X 7 X 54/36	66150	.342 (8.69)	0.26	198
G	1/0	7 X 7 X 86/36	105350	.431 (10.95)	0.16	263
H	2/0	7 X 7 X 108/36	133000	.483 (12.27)	0.13	305
I	3/0	19 X 7 X 51/36	169575	.547 (13.89)	0.10	351
J	4/0	19 X 7 X 64/36	212800	.613 (15.57)	0.08	411

Maximum ampacities are based on temperature rise to limits of the materials used in cable construction, based on single cable bundle in free air and at sea level pressure. Consult Glenair for more information.

Ambient Temp (°C)	Correction Factor
For ambient temperatures other than 40°C (104°F), multiply the allowable ampacities from the table above by the appropriate factor below	
41 – 50	0.97
51 – 60	0.94
61 – 70	0.90
71 – 80	0.87
81 – 90	0.83
91 – 100	0.79
101 – 120	0.71
121 – 140	0.61
141 – 160	0.50
161 – 180	0.35
181 – 200	----
201 – 255	----

Weatherproof, halogen free, flame resistant	
0	Black
1	Brown
2	Red
3	Orange
4	Yellow
5	Kelly Green
6	Blue
7	Violet
8	Gray
9	White

Consult factory for other specific colors

AWG Code	Weight lbs/1000 ft. (nom.)	Ø A in. (mm)	Insulation wall thickness in. (mm)
R	17.1	.187 (4.75)	.062 (1.57)
S	20.7	.204 (5.18)	
A	25.2	.223 (5.66)	
B	32.3	.250 (6.35)	
C	42.6	.283 (7.19)	
D	57.2	.324 (8.23)	
E	81.2	.395 (10.03)	
F	114.5	.466 (11.84)	
G	165.0	.555 (14.10)	
H	199.5	.607 (15.42)	
I	244.4	.671 (17.04)	
J	296.4	.737 (18.72)	

NOTES

- Bend radius is 3X the outer diameter
- Cable will be marked with "GLENAIR TURBOFLEX", wire gauge, part number, CAGE 06324.
- Insulation thickness tolerance is ±10%

TurboFlex® Aluminum Core, Duraelectric™ D Insulation, 2000 VAC, 961-148 Imperial

GENERAL-DUTY • ALUMINUM CORE

FEATURES

- For weight savings: all the benefits of TurboFlex wire and Duraelectric D insulation with lightweight aluminum core conductor

How to Order TurboFlex®					
Sample Part Number	961	-148	-A	-A	-2
Basic No.	TurboFlex with Duraelectric D Insulation				
Wall Thickness	-148 = .032"				
Conductor Material	-A = Aluminum (-65 – 200°C)				
Wire Size (See Table I)	R, S, A, B, C, D, E, F, G				
Duraelectric D Insulation Color	See Table II				

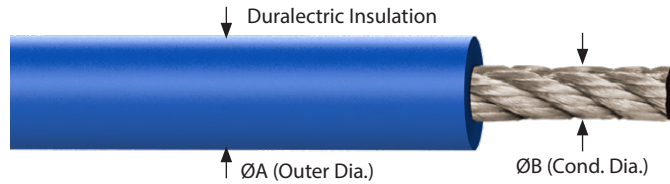

AWG Code	AWG	Strand / Count / AWG	Cir Mil (nom)	Ø B in. (mm)	DC Resistance @ 20°C (Ohms/1000 ft.)	Ampacity (Amps) 40°C Ambient
R	16	7 X 15/36	2625	.063 (1.60)	6.85	27
S	14	7 X 24/36	4200	.080 (2.03)	4.26	36
A	12	7 X 37/36	6475	.099 (2.51)	2.80	47
B	10	7 X 59/36	10325	.126 (3.20)	1.69	63
C	8	7 X 95/36	16625	.159 (4.04)	1.07	83
D	6	7 X 150/36	26250	.200 (5.08)	0.67	112
E	4	7 X 7 X 34/36	41650	.271 (6.88)	0.42	148
F	2	7 X 7 X 54/36	66150	.342 (8.69)	0.26	198
G	1/0	7 X 7 X 86/36	105350	.431 (10.95)	0.16	263

Maximum ampacities are based on temperature rise to limits of the materials used in cable construction, based on single cable bundle in free air and at sea level pressure. Consult Glenair for more information.

Ambient Temp (°C)	Correction Factor
41 – 50	0.97
51 – 60	0.94
61 – 70	0.90
71 – 80	0.87
81 – 90	0.83
91 – 100	0.79
101 – 120	0.71
121 – 140	0.61
141 – 160	0.50
161 – 180	0.35
181 – 200	----
201 – 255	----

Weatherproof, halogen free, flame resistant	
0	Black
1	Brown
2	Red
3	Orange
4	Yellow
5	Kelly Green
6	Blue
7	Violet
8	Gray
9	White

Consult factory for other specific colors

AWG Code	Weight lbs/1000 ft. (nom.)	Ø A in. (mm)	Insulation wall thickness in. (mm)
R	8.4	.127 (3.23)	.032 (0.81)
S	11.0	.144 (3.66)	
A	14.5	.163 (4.14)	
B	20.0	.190 (4.83)	
C	28.4	.223 (5.66)	
D	40.8	.264 (6.71)	
E	60.8	.335 (8.51)	
F	90.2	.406 (10.31)	
G	135.7	.495 (12.57)	

NOTES

- Bend radius is 3X the outer diameter
- Cable will be marked with "GLENAIR TURBOFLEX", wire gauge, part number, CAGE 06324.
- Insulation thickness tolerance is ±.005

TurboFlex® Aluminum Core, Duraelectric™ D Insulation, 1000 VAC, 961-151 Imperial

FEATURES

- For weight savings: all the benefits of TurboFlex wire and Duraelectric D insulation with lightweight aluminum core conductor

How to Order TurboFlex®					
Sample Part Number	961	-151	-A	-A	-2
Basic No.	TurboFlex with Duraelectric D Insulation				
Wall Thickness	-151 = .016"				
Conductor Material	-A = Aluminum (-65 – 200°C)				
Wire Size (See Table I)	R, S, A, B, C				
Duraelectric D Insulation Color	See Table II				

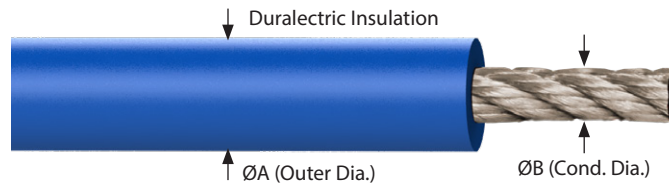

AWG Code	AWG	Strand / Count / AWG	Cir Mil (nom)	Ø B in. (mm)	DC Resistance @ 20°C (Ohms/1000 ft.)	Ampacity (Amps) 40°C Ambient
R	16	7 X 15/36	2625	.063 (1.60)	6.85	27
S	14	7 X 24/36	4200	.080 (2.03)	4.26	36
A	12	7 X 37/36	6475	.099 (2.51)	2.80	47
B	10	7 X 59/36	10325	.126 (3.20)	1.69	63
C	8	7 X 95/36	16625	.159 (4.04)	1.07	83

Maximum ampacities are based on temperature rise to limits of the materials used in cable construction, based on single cable bundle in free air and at sea level pressure. Consult Glenair for more information.

Ambient Temp (°C)	For ambient temperatures other than 40°C (104°F), multiply the allowable ampacities from the table above by the appropriate factor below
41 – 50	0.97
51 – 60	0.94
61 – 70	0.90
71 – 80	0.87
81 – 90	0.83
91 – 100	0.79
101 – 120	0.71
121 – 140	0.61
141 – 160	0.50
161 – 180	0.35
181 – 200	----
201 – 255	----

Weatherproof, halogen free, flame resistant	
0	Black
1	Brown
2	Red
3	Orange
4	Yellow
5	Kelly Green
6	Blue
7	Violet
8	Gray
9	White

Consult factory for other specific colors

AWG Code	Weight lbs/1000 ft. (nom.)	Ø A in. (mm)	Insulation wall thickness in. (mm)
R	5.1 (129.54)	.095 (2.41)	.016 (0.41)
S	7.2 (182.88)	.080 (2.03)	
A	10.1 (256.54)	.099 (2.51)	
B	14.8 (375.92)	.126 (3.20)	
C	22.3 (566.42)	.159 (4.04)	

NOTES

- Bend radius is 3X the outer diameter
- Cable will be marked with "GLENAIR TURBOFLEX", wire gauge, part number, CAGE 06324.
- Insulation thickness tolerance is ±.002

TurboFlex® Aluminum Core, Dual-Layer Duraelectric™ D Jackets and Metallic Braided Shield, 3000 VAC • 961-162 Imperial

HIGH-POWER SHIELDED • ALUMINUM CORE

FEATURES

- Metallic braided shield provides grounding for high-power applications.
- Black .093" Duraelectric D insulation to protect the conductor, surrounded with a metallic braided shield, with an outer .093" jacket for overall cable protection.

How to Order TurboFlex®					
Sample Part Number	961-162	-A	-T	-A	-2
Basic No.	TurboFlex with Duraelectric D Insulation / Jacket (.093" / .093")				
Conductor Material	-A = Aluminum (-65 - 200°C)				
Shield Material	-T = Tin/Copper (-65° - 150°C) -S = Silver/Copper (-65° - 200°C) -N = Nickel/Copper (-65° - 200°C)				
Wire Size (See Table I)	R, S, A, B, C, D, E, F, G, H, I, J, K, M, L				
Outer Duraelectric D Jacket Color	See Table II				

Table I: TurboFlex Wire Size, Dimensions

AWG Code	AWG	Strand/ Count/ AWG	Cir Mil (nom)	Ø A Conductor in. (mm)	ØE in. (mm)	"B" Insulation Wall Thickness in. (mm)	"C" Shield Thickness in. (mm)	"D" Outer Jacket Wall Thickness in. (mm)
R	16	7 X 15/36	2625	.063 (1.60)	.451 (11.46)	.093 (2.36)	.008 (0.20)	.093 (2.36)
S	14	7 X 24/36	4200	.080 (2.03)	.468 (11.89)			
A	12	7 X 37/36	6475	.099 (2.51)	.487 (12.37)			
B	10	7 X 59/36	10325	.126 (3.20)	.514 (13.06)			
C	8	7 X 95/36	16625	.159 (4.04)	.547 (13.89)			
D	6	7 X 150/36	26250	.200 (5.08)	.588 (14.94)			
E	4	7 X 7 X 34/36	41650	.271 (6.88)	.659 (16.74)			
F	2	7 X 7 X 54/36	66150	.342 (8.69)	.730 (18.54)			
G	1/0	7 X 7 X 86/36	105350	.431 (10.95)	.819 (20.80)			
H	2/0	7 X 7 X 108/36	132300	.483 (12.27)	.871 (22.12)			
I	3/0	19 X 7 X 51/36	169575	.547 (13.89)	.935 (23.75)			
J	4/0	19 X 7 X 64/36	212800	.613 (15.57)	1.001 (25.43)			
K	250 MCM	19 X 7 X 75/36	249375	.663 (16.84)	1.051 (26.70)			
M	350 MCM	19 X 7 X 106/36	352450	.789 (20.04)	1.177 (29.90)			
L	450 MCM	19 X 7 X 135/36	448875	.890 (22.61)	1.279 (32.49)			

Table II: Duraelectric™ D Jacket Color

Weatherproof, halogen free, flame resistant	
0	Black
1	Brown
2	Red
3	Orange
4	Yellow
5	Kelly Green
6	Blue
7	Violet
8	Gray
9	White
OG	Dark Olive Green
DT	Desert Tan

Consult factory for other specific colors

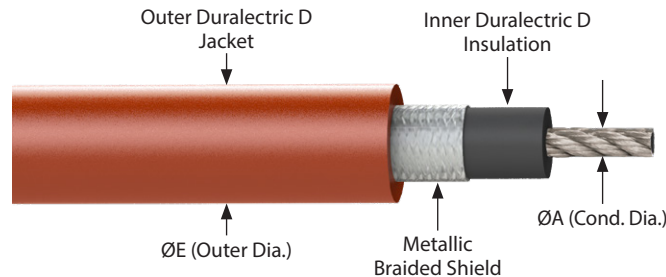

NOTES

1. Bend radius is 4X the outer diameter
2. Cable will be marked with "GLENAIR TURBOFLEX", wire gauge, part number, CAGE 06324.
3. Jacket thickness tolerance is ±10%
4. Braided shield has 90% optical coverage

TurboFlex® Aluminum Core, Dual-Layer Duralectric™ D Jackets and Metallic Braided Shield, 3000 VAC • 961-162 Imperial

Table I: TurboFlex DC Resistance and Ampacity Ratings

AWG Code	DC Resistance @ 20°C (Ohms / 1000 ft.)	Ampacity (Amps) 40°C Ambient	Braided Shield Ampacity (Amps) 30°C Ambient
R	6.85	27	53
S	4.26	36	35
A	2.80	47	35
B	1.69	63	42
C	1.07	83	42
D	0.67	112	53
E	0.42	148	55
F	0.26	198	62
G	0.16	263	70
H	0.13	305	77
I	0.10	351	77
J	0.08	411	71
K	0.07	446	71
L	0.04	642	80

Maximum ampacities are based on temperature rise to limits of the materials used in cable construction, based on single cable bundle in free air and at sea level pressure. Consult Glenair for more information.

Ampacity Ratings: Ambient Temperature Correction Factors

Ambient Temp (°C)	Correction Factor
For ambient temperatures other than 40°C (104°F), multiply the allowable ampacities from the table above by the appropriate factor below	
41 – 50	0.97
51 – 60	0.94
61 – 70	0.90
71 – 80	0.87
81 – 90	0.83
91 – 100	0.79
101 – 120	0.71
121 – 140	0.61
141 – 160	0.50
161 – 180	0.35
181 – 200	----
201 – 255	----

HIGH-POWER SHIELDED • ALUMINUM CORE

TurboFlex® Aluminum Core, Dual-Layer Duraelectric™ D Jackets and Metallic Braided Shield, 3000 VAC • 961-145 Imperial

HIGH-POWER SHIELDED • ALUMINUM CORE

FEATURES

- For weight savings: all the benefits of TurboFlex wire and Duraelectric D jacketing with lightweight aluminum core conductor
- Metallic braided shield provides grounding for high-power applications.
- Inner black Duraelectric D insulation to protect the conductor, surrounded with a metallic braided shield, with an outer jacket for overall cable protection.

How to Order TurboFlex®					
Sample Part Number	961-145	-A	-T	-A	-2
Basic No.	TurboFlex with .062" Duraelectric D Insulation / Jacketing				
Conductor Material	-A = Aluminum (-65 - 200°C)				
Braided Shield Material	-T = Tin/Copper (-65° - 150°C) -S = Silver/Copper (-65° - 200°C) -N = Nickel/Copper (-65° - 200°C)				
Wire Size (See Table I)	R, S, A, B, C, D, E, F, G, H, I, J, K, L				
Outer Duraelectric D Jacket Color	See Table II				

Table I: TurboFlex Wire Size, Dimensions

AWG Code	AWG	Strand / Count / AWG	Cir Mil (nom)	Ø A in. (mm)	"B" Insulation Wall Thickness in. (mm)	"C" Shield Thickness in. (mm)	"D" Outer Jacket Wall Thickness in. (mm)	Ø E in. (mm)
R	16	7 X 15/36	2625	.063 (1.60)	.062 (1.57)	.011 (0.28)	.062 (1.57)	.333 (8.46)
S	14	7 X 24/36	4200	.080 (2.03)				.350 (8.89)
A	12	7 X 37/36	6475	.099 (2.51)				.369 (9.37)
B	10	7 X 59/36	10325	.126 (3.20)				.396 (10.06)
C	8	7 X 95/36	16625	.159 (4.04)				.429 (10.90)
D	6	19 X 55/36	26125	.200 (5.08)				.470 (11.94)
E	4	7 X 7 X 34/36	41650	.271 (6.88)				.541 (13.74)
F	2	7 X 7 X 54/36	66150	.342 (8.69)				.612 (15.54)
G	1/0	7 X 7 X 86/36	105350	.431 (10.95)				.701 (17.81)
H	2/0	19 X 7 X 40/36	133000	.483 (12.27)				.753 (19.13)
I	3/0	19 X 7 X 51/36	169575	.547 (13.89)				.817 (20.75)
J	4/0	19 X 7 X 64/36	212800	.613 (15.57)				.883 (22.43)
K	250 MCM	19 X 7 X 75/36	249375	.663 (16.84)				.933 (23.70)
L	450 MCM	19 X 19 X 50/36	451250	.890 (22.61)	1.160 (29.46)			

Table II: Duraelectric™ D Jacket Color	
Weatherproof, halogen free, flame resistant	
0	Black
1	Brown
2	Red
3	Orange
4	Yellow
5	Kelly Green
6	Blue
7	Violet
8	Gray
9	White

Consult factory for other specific colors

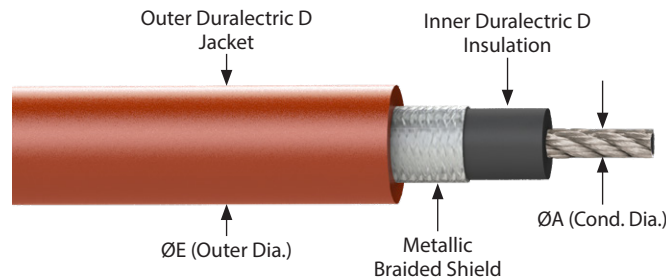

NOTES

- Bend radius is 4X the outer diameter
- Cable will be marked with "GLENAIR TURBOFLEX", wire gauge, part number, CAGE 06324.
- Jacket thickness tolerance is ±10%
- Braided shield has 90% optical coverage

TurboFlex® Aluminum Core, Dual-Layer Duralectric™ D Jackets and Metallic Braided Shield, 3000 VAC • 961-145 Imperial

Table I: TurboFlex DC Resistance and Ampacity Ratings

AWG Code	DC Resistance @ 20°C (Ohms / 1000 ft.)	Ampacity (Amps) 40°C Ambient	Braided Shield Ampacity (Amps) 30°C Ambient
R	6.85	27	32
S	4.26	36	46
A	2.80	47	46
B	1.69	63	53
C	1.07	83	35
D	0.67	112	42
E	0.42	148	53
F	0.26	198	56
G	0.16	263	62
H	0.13	305	70
I	0.10	351	77
J	0.08	411	77
K	0.07	446	88
L	0.04	642	80

Maximum ampacities are based on temperature rise to limits of the materials used in cable construction, based on single cable bundle in free air and at sea level pressure. Consult Glenair for more information.

Ampacity Ratings: Ambient Temperature Correction Factors

Ambient Temp (°C)	Correction Factor
For ambient temperatures other than 40°C (104°F), multiply the allowable ampacities from the table above by the appropriate factor below	
41 – 50	0.97
51 – 60	0.94
61 – 70	0.90
71 – 80	0.87
81 – 90	0.83
91 – 100	0.79
101 – 120	0.71
121 – 140	0.61
141 – 160	0.50
161 – 180	0.35
181 – 200	----
201 – 255	----

HIGH-POWER SHIELDED • ALUMINUM CORE

TurboFlex® Aluminum Core, Dual-Layer Duraelectric™ D Jackets and Metallic Braided Shield, 2000 VAC • 961-147 Imperial

HIGH-POWER SHIELDED • ALUMINUM CORE

FEATURES

- For weight savings: all the benefits of TurboFlex wire and Duraelectric D jacketing with lightweight aluminum core conductor
- Metallic braided shield provides grounding for high-power applications.
- Black Duraelectric D insulation to protect the conductor, surrounded with a metallic braided shield, with an outer jacket for overall cable protection.

How to Order TurboFlex®					
Sample Part Number	961-147	-A	-T	-A	-2
Basic No.	TurboFlex with .032" / .030" Duraelectric D Insulation / Jacket				
Conductor Material	-A = Aluminum (-65 - 200°C)				
Braided Shield Material	-T = Tin/Copper (-65° - 150°C) -S = Silver/Copper (-65° - 200°C) -N = Nickel/Copper (-65° - 200°C)				
Wire Size (See Table I)	R, S, A, B, C, D, E, F, G, H, I, J				
Outer Duraelectric D Jacket Color	See Table II				

Table I: TurboFlex Wire Size, Dimensions

AWG Code	AWG	Strand / Count / AWG	Cir Mil (nom)	Ø A in. (mm)	"B" Insulation Wall Thickness in. (mm)	"C" Shield Thickness in. (mm)	"D" Outer Jacket Wall Thickness in. (mm)	Ø E in. (mm)
R	16	7 X 15/36	2625	.063 (1.60)	.032 (0.81)	.011 (0.28)	.030 (0.76)	.209 (5.31)
S	14	7 X 24/36	4200	.080 (2.03)				.226 (5.74)
A	12	7 X 37/36	6475	.099 (2.51)				.245 (6.22)
B	10	7 X 59/36	10325	.126 (3.20)				.272 (6.91)
C	8	7 X 95/36	16625	.159 (4.04)				.305 (7.75)
D	6	19 X 55/36	26125	.200 (5.08)				.346 (8.79)
E	4	7 X 7 X 34/36	41650	.271 (6.88)				.417 (10.59)
F	2	7 X 7 X 54/36	66150	.342 (8.69)				.488 (12.40)
G	1/0	7 X 7 X 86/36	105350	.431 (10.95)				.577 (14.66)
H	2/0	19 X 7 X 40/36	133000	.483 (12.27)				.629 (15.98)
I	3/0	19 X 7 X 51/36	169575	.547 (13.89)	.693 (17.60)			
J	4/0	19 X 7 X 64/36	212800	.613 (15.57)	.759 (19.28)			

Table II: Duraelectric™ D Jacket Color

Weatherproof, halogen free, flame resistant	
0	Black
1	Brown
2	Red
3	Orange
4	Yellow
5	Kelly Green
6	Blue
7	Violet
8	Gray
9	White

Consult factory for other specific colors

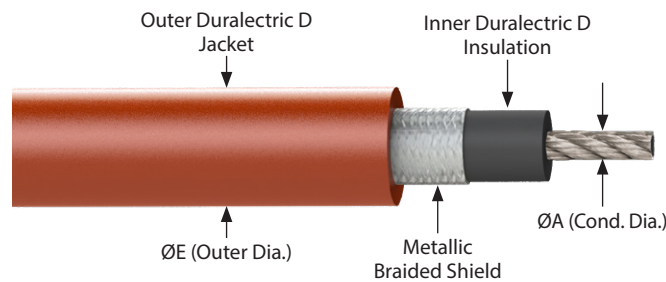

NOTES

- Bend radius is 4X the outer diameter
- Cable will be marked with "GLENAIR TURBOFLEX", wire gauge, part number, CAGE 06324.
- Jacket thickness tolerance is ±.005
- Braided shield has 90% optical coverage

TurboFlex® Aluminum Core, Dual-Layer Duralectric™ D Jackets and Metallic Braided Shield, 2000 VAC • 961-147 Imperial

Table I: TurboFlex DC Resistance and Ampacity Ratings			
AWG Code	DC Resistance @ 20°C (Ohms / 1000 ft.)	Ampacity (Amps) 40°C Ambient	Braided Shield Ampacity (Amps) 30°C Ambient
R	6.85	27	25
S	4.26	36	25
A	2.80	47	32
B	1.69	63	32
C	1.07	83	46
D	0.67	112	35
E	0.42	148	42
F	0.26	198	53
G	0.16	263	62
H	0.13	305	62
I	0.10	351	70
J	0.08	411	77

Maximum ampacities are based on temperature rise to limits of the materials used in cable construction, based on single cable bundle in free air and at sea level pressure. Consult Glenair for more information.

Ampacity Ratings: Ambient Temperature Correction Factors	
Ambient Temp (°C)	For ambient temperatures other than 40°C (104°F), multiply the allowable ampacities from the table above by the appropriate factor below
41 – 50	0.97
51 – 60	0.94
61 – 70	0.90
71 – 80	0.87
81 – 90	0.83
91 – 100	0.79
101 – 120	0.71
121 – 140	0.61
141 – 160	0.50
161 – 180	0.35
181 – 200	----
201 – 255	----

HIGH-POWER SHIELDED • ALUMINUM CORE

TurboFlex® Aluminum Core, Dual-Layer Duraelectric™ D Jackets and Metallic Braided Shield, 1000 VAC • 961-150 Imperial

HIGH-POWER SHIELDED • ALUMINUM CORE

FEATURES

- For weight savings: all the benefits of TurboFlex wire and Duraelectric D jacketing with lightweight aluminum core conductor
- Metallic braided shield provides grounding for high-power applications.
- Black Duraelectric D insulation to protect the conductor, surrounded with a metallic braided shield, with an outer jacket for overall cable protection.

How to Order TurboFlex®					
Sample Part Number	961-150	-A	-T	-A	-2
Basic No.	TurboFlex with .016" Duraelectric D Jackets				
Conductor Material	-A = Aluminum (-65 - 200°C)				
Braided Shield Material	-T = Tin/Copper (-65° - 150°C) -S = Silver/Copper (-65° - 200°C) -N = Nickel/Copper (-65° - 200°C)				
Wire Size (See Table I)	R, S, A, B, C, D, E, F, G				
Outer Duraelectric D Jacket Color	See Table II				

Table I: TurboFlex Wire Size, Dimensions

AWG Code	AWG	Strand / Count / AWG	Cir Mil (nom)	Ø A in. (mm)	"B" Insulation Wall Thickness in. (mm)	"C" Shield Thickness in. (mm)	"D" Outer Jacket Wall Thickness in. (mm)	Ø E in. (mm)
R	16	7 X 15/36	2625	.063 (1.60)	.016 (0.41)	.011 (0.28)	.016 (0.41)	.149 (3.78)
S	14	7 X 24/36	4200	.080 (2.03)				.166 (4.22)
A	12	7 X 37/36	6475	.099 (2.51)				.185 (4.70)
B	10	7 X 59/36	10325	.126 (3.20)				.212 (5.38)
C	8	7 X 95/36	16625	.159 (4.04)				.245 (6.22)
D	6	19 X 55/36	26125	.200 (5.08)				.286 (7.26)
E	4	7 X 7 X 34/36	41650	.271 (6.88)				.357 (9.07)
F	2	7 X 7 X 54/36	66150	.342 (8.69)	.428 (10.87)			
G	1/0	7 X 7 X 86/36	105350	.431 (10.95)	.517 (13.13)			

Table II: Duraelectric™ D Jacket Color	
Weatherproof, halogen free, flame resistant	
0	Black
1	Brown
2	Red
3	Orange
4	Yellow
5	Kelly Green
6	Blue
7	Violet
8	Gray
9	White
Consult factory for other specific colors	

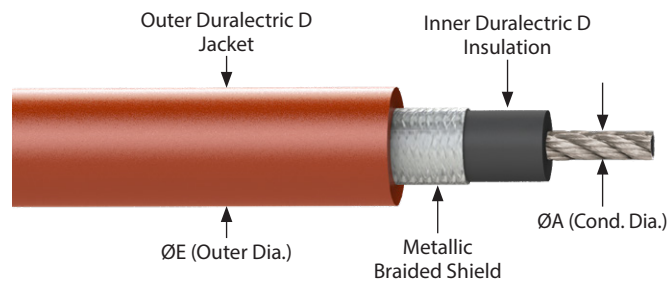

NOTES

- Bend radius is 4X the outer diameter
- Cable will be marked with "GLENAIR TURBOFLEX", wire gauge, part number, CAGE 06324.
- Jacket thickness tolerance is ±.002
- Braided shield has 90% optical coverage

TurboFlex® Aluminum Core, Dual-Layer Duralectric™ D Jackets and Metallic Braided Shield, 1000 VAC • 961-150 Imperial

Table I: TurboFlex DC Resistance and Ampacity Ratings

AWG Code	DC Resistance @ 20°C (Ohms / 1000 ft.)	Ampacity (Amps) 40°C Ambient	Braided Shield Ampacity (Amps) 30°C Ambient
R	6.85	27	16
S	4.26	36	19
A	2.80	47	25
B	1.69	63	40
C	1.07	83	32
D	0.67	112	46
E	0.42	148	35
F	0.26	198	53
G	0.16	263	55

Maximum ampacities are based on temperature rise to limits of the materials used in cable construction, based on single cable bundle in free air and at sea level pressure. Consult Glenair for more information.

Ampacity Ratings: Ambient Temperature Correction Factors

Ambient Temp (°C)	Correction Factor
41 – 50	0.97
51 – 60	0.94
61 – 70	0.90
71 – 80	0.87
81 – 90	0.83
91 – 100	0.79
101 – 120	0.71
121 – 140	0.61
141 – 160	0.50
161 – 180	0.35
181 – 200	----
201 – 255	----

For ambient temperatures other than 40°C (104°F), multiply the allowable ampacities from the table above by the appropriate factor below

HIGH-POWER SHIELDED • ALUMINUM CORE

TurboFlex® Aluminum Core, Dual-Layer Duraelectric™ D Jackets, Microfilament Braided Shield, 3000 VAC • 961-164 Imperial

MICROFILAMENT BRAIDED • ALUMINUM CORE

FEATURES

- Glenair microfilament braided shield (ArmorLite™ or AmberStrand) provides lightweight grounding.
- Black Duraelectric D insulation to protect the conductor, surrounded with a lightweight microfilament braided shield, with an outer jacket for overall cable protection.

How to Order TurboFlex®					
Sample Part Number	961-164	-A	-AM	-A	-2
Basic No.	TurboFlex with Duraelectric D Insulation / Jacket (.093" / .093")				
Conductor Material	-A = Aluminum (-65 – 200°C)				
Braided Shield Material	-AM = AmberStrand -AR = ArmorLite -CF = ArmorLite CF				
Wire Size (See Table I)	R, S, A, B, C, D, E, F, G, H, I, J, K, L				
Outer Duraelectric D Jacket Color	See Table II				

AWG Code	AWG	Strand/ Count/ AWG	Cir Mil (nom)	Ø A Conductor in. (mm)	ØE in. (mm)	"B" Insulation Wall Thickness in. (mm)	"C" Shield Thickness in. (mm)	"D" Outer Jacket Wall Thickness in. (mm)
R	16	7 X 15/36	2625	.063 (1.60)	.451 (11.46)	.093 (2.36)	.008 (0.20)	.093 (2.36)
S	14	7 X 24/36	4200	.080 (2.03)	.468 (11.89)			
A	12	7 X 37/36	6475	.099 (2.51)	.487 (12.37)			
B	10	7 X 59/36	10325	.126 (3.20)	.514 (13.06)			
C	8	7 X 95/36	16625	.159 (4.04)	.547 (13.89)			
D	6	19 X 55/36	26125	.200 (5.08)	.588 (14.94)			
E	4	7 X 7 X 34/36	41650	.271 (6.88)	.659 (16.74)			
F	2	7 X 7 X 54/36	66150	.342 (8.69)	.730 (18.54)			
G	1/0	7 X 7 X 86/36	105350	.431 (10.95)	.819 (20.80)			
H	2/0	19 X 7 X 40/36	133000	.483 (12.27)	.871 (22.12)			
I	3/0	19 X 7 X 51/36	169575	.547 (13.89)	.935 (23.75)			
J	4/0	19 X 7 X 64/36	212800	.613 (15.57)	1.001 (25.43)			
K	250 MCM	19 X 7 X 75/36	249375	.663 (16.84)	1.051 (26.70)			
L	450 MCM	19 X 19 X 50/36	451250	.890 (22.61)	1.278 (32.46)			

Weatherproof, halogen free, flame resistant	
0	Black
1	Brown
2	Red
3	Orange
4	Yellow
5	Kelly Green
6	Blue
7	Violet
8	Gray
9	White
OG	Dark Olive Green
DT	Desert Tan

Consult factory for other specific colors

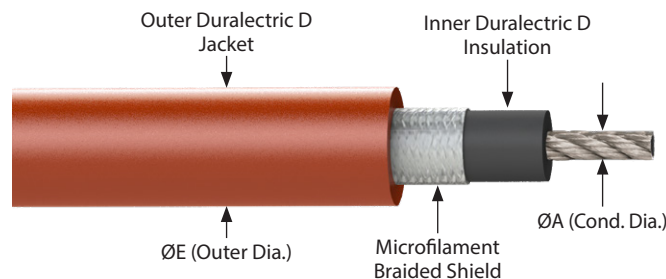

NOTES

- Bend radius is 4X the outer diameter
- Cable will be marked with "GLENAIR TURBOFLEX", wire gauge, part number, CAGE 06324.
- Jacket thickness tolerance is ±10%
- Braided shield has 90% optical coverage

TurboFlex® Aluminum Core, Dual-Layer Duralectric™ D Jackets, Microfilament Braided Shield, 3000 VAC • 961-164 Imperial

Table I: TurboFlex DC Resistance and Ampacity Ratings

AWG Code	DC Resistance @ 20°C (Ohms / 1000 ft.)	Ampacity (Amps) 40°C Ambient
R	6.85	27
S	4.26	36
A	2.80	47
B	1.69	63
C	1.07	83
D	0.67	112
E	0.42	148
F	0.26	198
G	0.16	263
H	0.13	305
I	0.10	351
J	0.08	411
K	0.07	446
L	0.04	642

Maximum ampacities are based on temperature rise to limits of the materials used in cable construction, based on single cable bundle in free air and at sea level pressure. Consult Glenair for more information.

Ampacity Ratings: Ambient Temperature Correction Factors

Ambient Temp (°C)	For ambient temperatures other than 40°C (104°F), multiply the allowable ampacities from the table above by the appropriate factor below
41 – 50	0.97
51 – 60	0.94
61 – 70	0.90
71 – 80	0.87
81 – 90	0.83
91 – 100	0.79
101 – 120	0.71
121 – 140	0.61
141 – 160	0.50
161 – 180	0.35
181 – 200	----
201 – 255	----

MICROFILAMENT BRAIDED • ALUMINUM CORE

TurboFlex® Aluminum Core, Dual-Layer Duraelectric™ D Jackets, Microfilament Braided Shield, 3000 VAC • 961-154 Imperial

MICROFILAMENT BRAIDED • ALUMINUM CORE

FEATURES

- Weight-saving aluminum core conductor
- Glenair microfilament braided shield (ArmorLite™ or AmberStrand) provides lightweight grounding.
- Black Duraelectric D insulation to protect the conductor, surrounded with a lightweight microfilament braided shield, with an outer jacket for overall cable protection.

How to Order TurboFlex®					
Sample Part Number	961-154	-A	-AM	-A	-2
Basic No.	TurboFlex with .062" Duraelectric D Insulation / Jacket				
Conductor Material	-A = Aluminum (-65 – 200°C)				
Braided Shield Material	-AM = AmberStrand -AR = ArmorLite -CF = ArmorLite CF				
Wire Size (See Table I)	R, S, A, B, C, D, E, F, G, H, I, J, K, L				
Outer Duraelectric D Jacket Color	See Table II				

Table I: TurboFlex Wire Size, Dimensions

AWG Code	AWG	Strand / Count / AWG	Cir Mil (nom)	Ø A in. (mm)	"B" Insulation Wall Thickness in. (mm)	"C" Shield Thickness in. (mm)	"D" Outer Jacket Wall Thickness in. (mm)	Ø E in. (mm)
R	16	7 X 15/36	2625	.063 (1.60)	.062 (1.57)	.008 (0.20)	.062 (1.57)	.327 (8.31)
S	14	7 X 24/36	4200	.080 (2.03)				.344 (8.74)
A	12	7 X 37/36	6475	.099 (2.51)				.363 (9.22)
B	10	7 X 59/36	10325	.126 (3.20)				.390 (9.91)
C	8	7 X 95/36	16625	.159 (4.04)				.423 (10.74)
D	6	19 X 55/36	26125	.200 (5.08)				.464 (11.79)
E	4	7 X 7 X 34/36	41650	.271 (6.88)				.535 (13.59)
F	2	7 X 7 X 54/36	66150	.342 (8.69)				.606 (15.39)
G	1/0	7 X 7 X 86/36	105350	.431 (10.95)				.695 (17.65)
H	2/0	7 X 7 X 108/36	133000	.483 (12.27)				.747 (18.97)
I	3/0	19 X 7 X 51/36	169575	.547 (13.89)				.811 (20.60)
J	4/0	19 X 7 X 64/36	212800	.613 (15.57)				.877 (22.28)
K	250 MCM	19 X 7 X 75/36	249375	.663 (16.84)				.927 (23.55)
L	450 MCM	19 X 19 X 50/36	451250	.890 (22.61)				1.154 (29.31)

Table II: Duraelectric™ D Jacket Color

Weatherproof, halogen free, flame resistant	
0	Black
1	Brown
2	Red
3	Orange
4	Yellow
5	Kelly Green
6	Blue
7	Violet
8	Gray
9	White

Consult factory for other specific colors

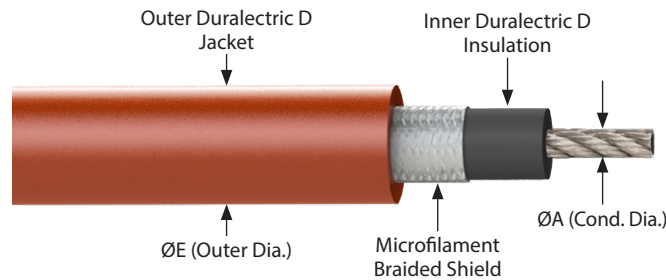

NOTES

1. Bend radius is 4X the outer diameter
2. Cable will be marked with "GLENAIR TURBOFLEX", wire gauge, part number, CAGE 06324.
3. Jacket thickness tolerance is ±10%
4. Braided shield has 90% optical coverage

TurboFlex® Aluminum Core, Dual-Layer Duralectric™ D Jackets, Microfilament Braided Shield, 3000 VAC • 961-154 Imperial

Table I: TurboFlex DC Resistance and Ampacity Ratings

AWG Code	DC Resistance @ 20°C (Ohms / 1000 ft.)	Ampacity (Amps) 40°C Ambient
R	6.85	27
S	4.26	36
A	2.80	47
B	1.69	63
C	1.07	83
D	0.67	112
E	0.42	148
F	0.26	198
G	0.16	263
H	0.13	305
I	0.10	351
J	0.08	411
K	0.07	446
L	0.04	642

Maximum ampacities are based on temperature rise to limits of the materials used in cable construction, based on single cable bundle in free air and at sea level pressure. Consult Glenair for more information.

Ampacity Ratings: Ambient Temperature Correction Factors

Ambient Temp (°C)	For ambient temperatures other than 40°C (104°F), multiply the allowable ampacities from the table above by the appropriate factor below
41 – 50	0.97
51 – 60	0.94
61 – 70	0.90
71 – 80	0.87
81 – 90	0.83
91 – 100	0.79
101 – 120	0.71
121 – 140	0.61
141 – 160	0.50
161 – 180	0.35
181 – 200	----
201 – 255	----

MICROFILAMENT BRAIDED • ALUMINUM CORE

TurboFlex® Aluminum Core, Dual-Layer Duraelectric™ D Jackets, Microfilament Braided Shield, 2000 VAC • 961-156 Imperial

MICROFILAMENT BRAIDED • ALUMINUM CORE

FEATURES

- Weight-saving aluminum core conductor
- Glenair microfilament braided shield (ArmorLite™ or AmberStrand) provides lightweight grounding.
- Black Duraelectric D insulation to protect the conductor, surrounded with a lightweight microfilament braided shield, with an outer jacket for overall cable protection.

How to Order TurboFlex®					
Sample Part Number	961-156	-A	-AM	-A	-2
Basic No.	TurboFlex with .032" / .030" Duraelectric D Insulation / Jacket				
Conductor Material	-A = Aluminum (-65 – 200°C)				
Braided Shield Material	-AM = AmberStrand -AR = ArmorLite -CF = ArmorLite CF				
Wire Size (See Table I)	R, S, A, B, C, D, E, F, G, H, I, J				
Outer Duraelectric D Jacket Color	See Table II				

Table I: TurboFlex Wire Size, Dimensions

AWG Code	AWG	Strand / Count / AWG	Cir Mil (nom)	Ø A in. (mm)	"B" Insulation Wall Thickness in. (mm)	"C" Shield Thickness in. (mm)	"D" Outer Jacket Wall Thickness in. (mm)	Ø E in. (mm)
R	16	7 X 15/36	2625	.063 (1.60)	.032 (0.81)	.008 (0.20)	.030 (0.76)	.203 (5.16)
S	14	7 X 24/36	4200	.080 (2.03)				.220 (5.59)
A	12	7 X 37/36	6475	.099 (2.51)				.239 (6.07)
B	10	7 X 59/36	10325	.126 (3.20)				.266 (6.76)
C	8	7 X 95/36	16625	.159 (4.04)				.299 (7.59)
D	6	19 X 55/36	26125	.200 (5.08)				.340 (8.64)
E	4	7 X 7 X 34/36	41650	.271 (6.88)				.411 (10.44)
F	2	7 X 7 X 54/36	66150	.342 (8.69)				.482 (12.24)
G	1/0	7 X 7 X 86/36	105350	.431 (10.95)				.571 (14.50)
H	2/0	19 X 7 X 40/36	133000	.483 (12.27)				.623 (15.82)
I	3/0	19 X 7 X 51/36	169575	.547 (13.89)	.687 (17.45)			
J	4/0	19 X 7 X 64/36	212800	.613 (15.57)	.753 (19.13)			

Table II: Duraelectric™ D Jacket Color

Weatherproof, halogen free, flame resistant	
0	Black
1	Brown
2	Red
3	Orange
4	Yellow
5	Kelly Green
6	Blue
7	Violet
8	Gray
9	White

Consult factory for other specific colors

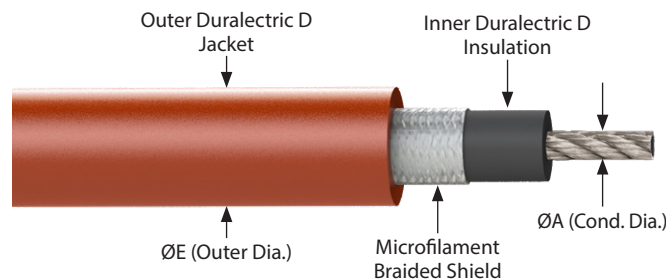

NOTES

1. Bend radius is 4X the outer diameter
2. Cable will be marked with "GLENAIR TURBOFLEX", wire gauge, part number, CAGE 06324.
3. Jacket thickness tolerance is ±.005
4. Braided shield has 90% optical coverage

TurboFlex® Aluminum Core, Dual-Layer Duralectric™ D Jackets, Microfilament Braided Shield, 2000 VAC • 961-156 Imperial

Table I: TurboFlex DC Resistance and Ampacity Ratings

AWG Code	DC Resistance @ 20°C (Ohms / 1000 ft.)	Ampacity (Amps) 40°C Ambient
R	6.85	27
S	4.26	36
A	2.80	47
B	1.69	63
C	1.07	83
D	0.67	112
E	0.42	148
F	0.26	198
G	0.16	263
H	0.13	305
I	0.10	351
J	0.08	411

Maximum ampacities are based on temperature rise to limits of the materials used in cable construction, based on single cable bundle in free air and at sea level pressure. Consult Glenair for more information.

Ampacity Ratings: Ambient Temperature Correction Factors

Ambient Temp (°C)	Correction Factor
For ambient temperatures other than 40°C (104°F), multiply the allowable ampacities from the table above by the appropriate factor below	
41 – 50	0.97
51 – 60	0.94
61 – 70	0.90
71 – 80	0.87
81 – 90	0.83
91 – 100	0.79
101 – 120	0.71
121 – 140	0.61
141 – 160	0.50
161 – 180	0.35
181 – 200	----
201 – 255	----

MICROFILAMENT BRAIDED • ALUMINUM CORE

TurboFlex® Aluminum Core, Dual-Layer Duraelectric™ D Jackets, Microfilament Braided Shield, 1000 VAC • 961-158 Imperial

MICROFILAMENT BRAIDED • ALUMINUM CORE

FEATURES

- Weight-saving aluminum core conductor
- Glenair microfilament braided shield (ArmorLite™ or AmberStrand) provides lightweight grounding.
- Black Duraelectric D insulation to protect the conductor, surrounded with a lightweight microfilament braided shield, with an outer jacket for overall cable protection.

How to Order TurboFlex®					
Sample Part Number	961-158	-A	-AM	-A	-2
Basic No.	TurboFlex with .016" Duraelectric D Insulation / Jacket				
Conductor Material	-A = Aluminum (-65 – 200°C)				
Braided Shield Material	-AM = AmberStrand -AR = ArmorLite -CF = ArmorLite CF				
Wire Size (See Table I)	R, S, A, B, C, D, E, F, G				
Outer Duraelectric D Jacket Color	See Table II				

Table I: TurboFlex Wire Size, Dimensions

AWG Code	AWG	Strand / Count / AWG	Cir Mil (nom)	Ø A in. (mm)	"B" Insulation Wall Thickness in. (mm)	"C" Shield Thickness in. (mm)	"D" Outer Jacket Wall Thickness in. (mm)	Ø E in. (mm)
R	16	7 X 15/36	2625	.063 (1.60)	.016 (0.41)	.008 (0.20)	.016 (0.41)	.143 (3.63)
S	14	7 X 24/36	4200	.080 (2.03)				.160 (4.06)
A	12	7 X 37/36	6475	.099 (2.51)				.179 (4.55)
B	10	7 X 59/36	10325	.126 (3.20)				.206 (5.23)
C	8	7 X 95/36	16625	.159 (4.04)				.239 (6.07)
D	6	19 X 55/36	26125	.200 (5.08)				.280 (7.11)
E	4	7 X 7 X 34/36	41650	.271 (6.88)				.351 (8.92)
F	2	7 X 7 X 54/36	66150	.342 (8.69)	.422 (10.72)			
G	1/0	7 X 7 X 86/36	105350	.431 (10.95)	.511 (12.98)			

Table II: Duraelectric™ D Jacket Color

Weatherproof, halogen free, flame resistant	
0	Black
1	Brown
2	Red
3	Orange
4	Yellow
5	Kelly Green
6	Blue
7	Violet
8	Gray
9	White

Consult factory for other specific colors

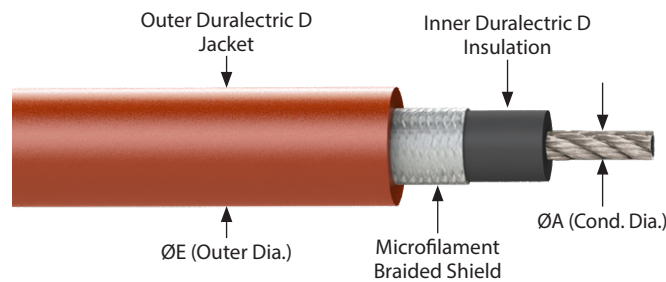

NOTES

1. Bend radius is 4X the outer diameter
2. Cable will be marked with "GLENAIR TURBOFLEX", wire gauge, part number, CAGE 06324.
3. Jacket thickness tolerance is ±.002
4. Braided shield has 90% optical coverage

TurboFlex® Aluminum Core, Dual-Layer Duralectric™ D Jackets, Microfilament Braided Shield, 1000 VAC • 961-158 Imperial

Table I: TurboFlex DC Resistance and Ampacity Ratings

AWG Code	DC Resistance @ 20°C (Ohms / 1000 ft.)	Ampacity (Amps) 40°C Ambient
R	6.85	27
S	4.26	36
A	2.80	47
B	1.69	63
C	1.07	83
D	0.67	112
E	0.42	148
F	0.26	198
G	0.16	263

Maximum ampacities are based on temperature rise to limits of the materials used in cable construction, based on single cable bundle in free air and at sea level pressure. Consult Glenair for more information.

Ampacity Ratings: Ambient Temperature Correction Factors

Ambient Temp (°C)	For ambient temperatures other than 40°C (104°F), multiply the allowable ampacities from the table above by the appropriate factor below
41 – 50	0.97
51 – 60	0.94
61 – 70	0.90
71 – 80	0.87
81 – 90	0.83
91 – 100	0.79
101 – 120	0.71
121 – 140	0.61
141 – 160	0.50
161 – 180	0.35
181 – 200	----
201 – 255	----

MICROFILAMENT BRAIDED • ALUMINUM CORE

TurboFlex® Aluminum Core, Duralectric™ D Insulation and Fabric Overbraid, 1000-3500 VAC • 961-167 Imperial

ABRASION-RESISTANT • HIGH-TEMP • ALUMINUM CORE

FEATURES

- Fabric overbraid provides abrasion and temperature protection. Choose the appropriate braid with the selection guide table at right.
- Voltage rating is dependent on insulation wall thickness, select per application requirements.

How to Order TurboFlex®	
Sample Part Number	961-167 -1 -A -G -2 -D -B
Basic No.	TurboFlex with Duralectric D Insulation and fabric overbraid
Wall Thickness	-2 = .093" (3500 VAC) -3 = .062" (3000 VAC) -4 = .032" (2000 VAC) -5 = .016"
Conductor Material	-A = Aluminum (-65° - 200°C)
Wire Size (See Table I)	See Table I: (Conductor size availability depends on Insulation thickness) A, B, C, D, E, F, G, H, I, J, K, L, R, S
Duralectric D Insulation Color	See Table II
Braid Material	See Braid Material and Color Selection Guide
Braid Color	See Braid Material and Color Selection Guide

Table I: Conductor Size Code (availability depends on insulation thickness)

Conductor size (AWG)	Insulation Thickness in. (mm)			
	.093	.062	.032	.016
16	R	R	R	R
14	S	S	S	S
12	A	A	A	A
10	B	B	B	B
8	C	C	C	C
6	D	D	D	
4	E	E	E	
2	F	F	F	
1/0	G	G	G	
2/0	H	H		
3/0	I	I		
4/0	J	J		
250 MCM	K			
450 MCM	L			

Table IV: Approximate Outer Diameter

Conductor size (AWG)	Insulation Thickness in. (mm)			
	.093	.062	.032	.016
16	.31 (7.87)	.25 (6.35)	.19 (4.83)	.16 (4.06)
14	.33 (8.38)	.26 (6.60)	.20 (5.08)	.17 (4.32)
12	.35 (8.89)	.28 (7.11)	.22 (5.59)	.19 (4.83)
10	.37 (9.40)	.31 (7.87)	.25 (6.35)	.22 (5.59)
8	.41 (10.41)	.34 (8.64)	.28 (7.11)	.25 (6.35)
6	.45 (11.43)	.38 (9.65)	.32 (8.13)	
4	.52 (13.21)	.46 (11.68)	.40 (10.16)	
2	.59 (14.99)	.53 (13.46)	.47 (11.94)	
1/0	.68 (17.27)	.62 (15.75)	.56 (14.22)	
2/0	.73 (18.54)	.67 (17.02)		
3/0	.79 (20.07)	.73 (18.54)		
4/0	.86 (21.84)	.80 (20.32)		
250 MCM	.91 (23.11)			
450 MCM	1.14 (28.96)			

Table II: Duralectric D Insulation Color

	Weatherproof, halogen free, flame resistant
0	Black
1	Brown
2	Red
3	Orange
4	Yellow
5	Kelly Green
6	Blue
7	Violet
8	Gray
9	White

Consult factory for other specific colors

Table III: Voltage Rating

Insulation Thickness	AC Voltage Rating, RMS
.093 (2.36)	3500
.062 (1.57)	3000
.032 (0.81)	2000
.016 (0.41)	1000

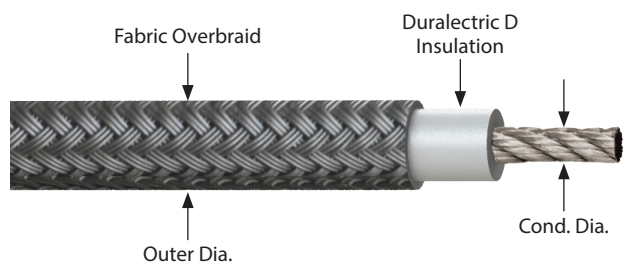

NOTES

1. Cable will be tagged with complete part number

TurboFlex® Aluminum Core, Duralectric™ D Insulation and Fabric Overbraid, 1000-3500 VAC • 961-167 Imperial

Braid Material and Color Selection Guide										
Principal Selection Criteria	General Duty / Abrasion Resistance					Economy		Temperature Tolerance	Fire Resistance	
Braid Code Material Construction	Z Monofilament FEP	P Monofilament PET, Type FR	H Monofilament Halar®	M Yarn, Nomex®	R Monofilament Ryton, Type R-7	D Yarn, Dacron®	Y Yarn, Nylon	K Monofilament PEEK	X Yarn, PTFE-Glass	V Yarn, Kevlar®
Color Code Options	C = Clear	B = Black W = White	B = Black W = White BW = Black w/ White Tracer WB = White w/ Black Tracer	B = Black R = Red OR = Orange GN = Green GY = Gray W = White TN = Desert Tan	N = Natural	B = Black	B = Black GY = Gray OD = Olive Drab	B = Black	BR = Brown N = Natural	B = Black N = Natural
Halogen-Free	NO		NO						NO	
Temperature Range	-55°C to +200°C	-55°C to +125°C	-65°C to +150°C	-55°C to +200°C	-65°C to +180°C	-62°C to +125°C	-20° to +170°	-65°C to +260°C	-204°C to +482°C	-73°C to +160°C
Tensile Strength (PSI) Yield	3300	50,000	7000	90,000	19,000	10,000	12,400	13,000	450,000	400,000
Elongation Percentage	50%	20%	15%	25%	40%	12%	90%	38%	5%	3.6%
Chemical Resistance	Excellent	Good	Excellent	Excellent	Excellent	Good	Excellent	Excellent	Excellent	Excellent
Abrasion Resistance	Good	Good	Excellent	Good	Excellent	Fair	Excellent	Excellent	Excellent	Good
Weight / Duty (specific gravity)	Heavy (2.17)	Medium (1.38)	Medium (1.68)	Medium (1.58)	Light (1.25)	Medium (1.38)	Light (1.14)	Light (1.3)	Heavy (2.5)	Medium (1.44)
Flammability	Very Low	Flammable, Self-Extinguishing	Very Low	Will Not Melt	Very Low	Flammable	Flammable	Very Low	Will Not Burn	Will Not Melt

Braid Code	Braid Material (and temperature range)	Aluminum (-60/+200)
D	Dacron (-62/+125)	(-65/+125)
H	Halar (-65/+150)	(-65/+150)
Y	Nylon (-20/+170)	(-20/+150)
M	Nomex (-55/+200)	(-55/+150)
P	Polyester Type FR (-55/+125)	(-55/+125)
Z	FEP Teflon (-55/+200)	(-55/+150)
R	Ryton Type R-7 (-65/+180)	(-65/+150)
K	PEEK (-65/+260)	(-65/+150)
V	Kevlar (-73/+160)	(-65/+150)
X	PTFE-Glass (-204/+482)	(-65/+150)

DuPont™ Nomex® and Kevlar® are trademarks or registered trademarks of E.I. duPont de Nemours and Company. All other marks and brands are registered to, or possessions of, their respective owners and/or companies.

ABRASION-RESISTANT • HIGH-TEMP • ALUMINUM CORE

TurboFlex® Aluminum Core, Lightweight Duraelectric™ L Insulation, 1250 VAC • 961-042 Imperial

LIGHTWEIGHT INSULATION

FEATURES

- TurboFlex with Duraelectric L (light) insulation and aluminum conductor for lightest weight and best abrasion resistance

How to Order TurboFlex®				
Sample Part Number	961-042	-A	-C	-2
Basic No.	TurboFlex with .025" Duraelectric L (light) Insulation, aluminum conductor			
Conductor Material	-A = Aluminum (-65 – 200°C)			
Wire Size (See Table I)	R, S, A, B, C, D, E, F, G			
Duraelectric L Insulation Color	See Table II			

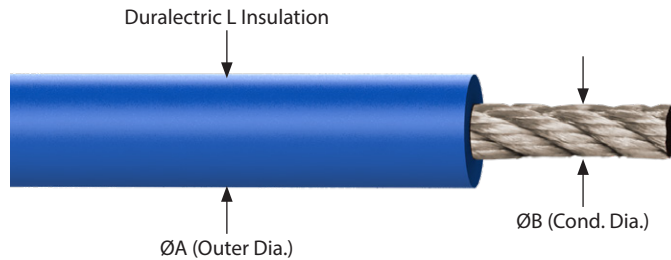

AWG Code	AWG	Strand / Count / AWG	Cir Mil (nom)	Ø B in. (mm)	DC Resistance @ 20°C (Ohms / 1000 ft.)	Typical Ampacity (Amps) 40°C Ambient
R	16	7 X 15/36	2625	.063 (1.60)	6.85	15–25
S	14	7 X 24/36	4200	.080 (2.03)	4.26	15–35
A	12	7 X 37/36	6475	.099 (2.51)	2.80	25–45
B	10	7 X 59/36	10325	.126 (3.20)	1.69	30–60
C	8	7 X 95/36	16625	.159 (4.04)	1.07	45–90
D	6	7 X 150/36	26250	.200 (5.08)	0.67	60–120
E	4	7 X 7 X 34/36	41650	.271 (6.88)	0.42	80–165
F	2	7 X 7 X 54/36	66150	.342 (8.69)	0.26	115–130
G	1/0	7 X 7 X 86/36	105350	.431 (10.95)	0.16	150–310

Maximum ampacities are based on temperature rise to limits of the materials used in cable construction, based on single cable bundle in free air and at sea level pressure. Consult Glenair for more information.

Weatherproof, halogen free, flame resistant	
0	Black
1	Brown
2	Red
3	Orange
4	Yellow
5	Kelly Green
6	Blue
7	Violet
8	Gray
9	White

Consult factory for other specific colors

AWG Code	Weight lbs/1000 ft. (nom.)	Ø A in. (mm)	Insulation wall thickness in. (mm)
R	5.4	.113 (2.87)	.025 (.64)
S	7.5	.130 (2.54)	
A	10.3	.149 (3.78)	
B	14.9	.176 (4.47)	
C	22.1	.209 (5.31)	
D	32.8	.250 (6.35)	
E	50.0	.321 (8.15)	
F	76.0	.392 (9.96)	
G	116.9	.481 (12.22)	

NOTES

1. Bend radius is 3X the outer diameter
2. Cable will be marked with "GLENAIR ALUMINUM TURBOFLEX LIGHT", wire gauge, part number, CAGE 06324.
3. Insulation thickness tolerance is ±.005

TurboFlex® Insulation stripping procedure

STEP 1

Using scale, mark off required length of insulation to be removed. Wrap tape around diameter of cable to provide a visual guide to indicate where jacket shall be scored.

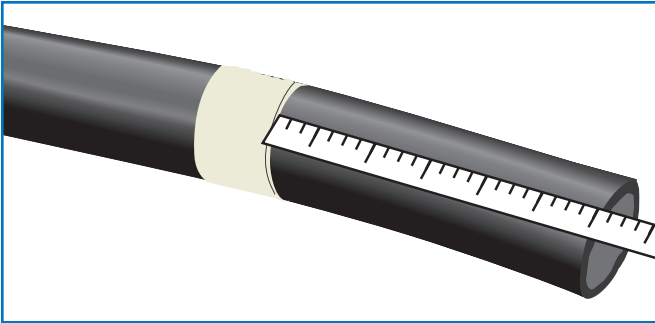

STEP 2

A) Make a shallow incision (score) at the guide mark. It is not necessary to cut completely through the outer jacket. Continue scoring the insulation around the complete circumference of the cable.

Note: when scoring insulation be sure not to cut completely through the outer material which could damage wire strands.

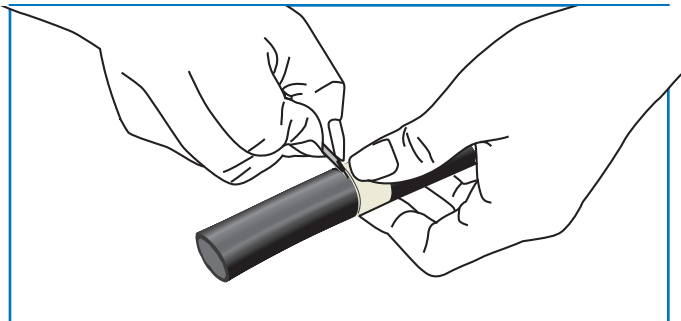

B) Score insulation lengthwise along the entire section of insulation to be removed.

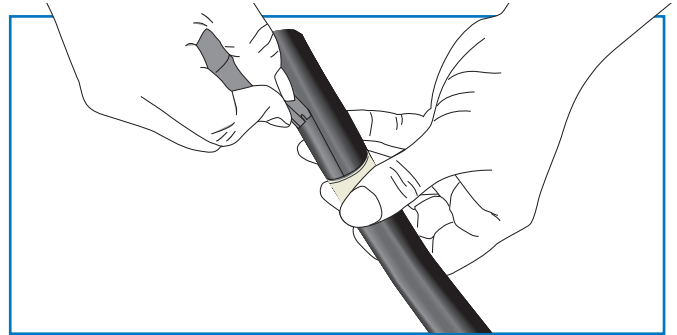

C) Using needle nose pliers, grab the insulation material where the lengthwise score meets the guide mark. Gently pull the insulation away, working downwards along the incision towards the end of the cable. Once insulation is removed wire is ready for crimp termination.

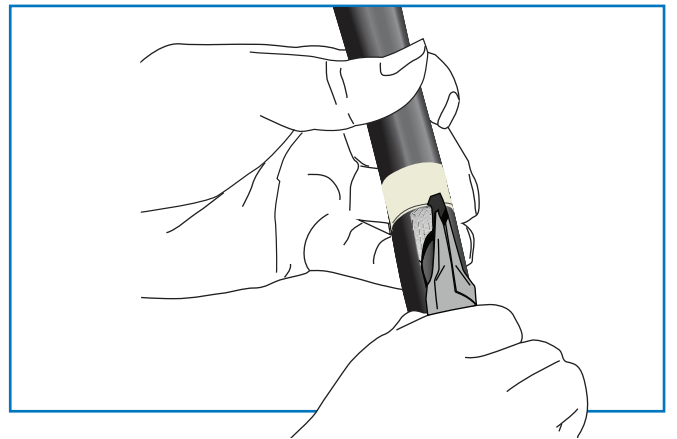

STEP 3

If crimp process will not be completed immediately, wrap exposed wire strands with tape to prevent fraying.

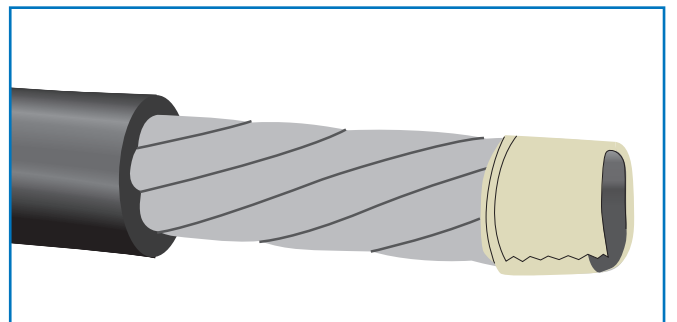

INSULATION STRIPPING • WIRE CRIMPING

TurboFlex® Wire crimping notes

INSULATION STRIPPING • WIRE CRIMPING

Since wire gauges are defined by the cross sectional area of the metal conductor, please note the outer diameter of TurboFlex wires may be slightly larger than other wires of the same gauge. Consult the catalog pages for wire dimensions.

NOTE 1

Select appropriate crimp tool and die set as recommended by contact manufacturer. For optimal results, Glenair recommends the use of an indenting-type crimp die over a hex-style crimper.

NOTE 2

Always follow contact manufacturer specifications for minimum and maximum wire dimensions for the given contact size.

NOTE 3

Check TurboFlex wire-to-contact fit. The wire should fit freely but snugly into the crimp barrel. Never trim away individual strands to force-fit wire into a too-small crimp barrel.

NOTE 4

When crimping, hold the crimp die closed for a minimum of 8 seconds to allow adequate dwell time for wire strand deformation. Too-rapid crimping can result in a mechanically weak crimp joint.



107-111 TurboFlex® Rope-Lay Wire Rope Grounding Strap



How To Order TurboFlex Grounding Straps							
Sample Part Number	107-111	T	-E	-SR	-A	E	-8 D2
Product Series	TurboFlex Ground Strap						
TurboFlex Wire and Lug Material	T = Copper / Tin Plated S = Copper / Silver Plated N = Copper / Nickel Plated						
Wire Size	See tables						
Ground Strap Style	SR = Strain Relief Lugs FRD = Flat Radiused Lugs 20 = MS20659 Lugs 25 = MS25036 Lugs TCT = TurboFlex Crimp Terminal Lugs						
Lug 1 Hole Code	Table II						
Lug 2 Hole Code	Table II						
Length	In Inches						
Jacket Material Code	Table III Omit = no jacket						

GROUND STRAPS

GROUND STRAP FEATURES

- Lug hole table in accordance with AS7928.
- Bend radius is 3X the O.D.

MATERIAL/FINISH

- Lugs - See table. Mil-Spec lugs Copper/tin plate per B545
- Conductor - Copper/tin, silver, or nickel plated, See table
- Jacket/ Sleeve - See table

Lug 1 & 2 Hole Code	∅ C	Stud Size (Ref.)
X	.000	No Lug Hole
A	.114/.122 (2.90/3.10)	#4
B	.142/.152 (3.61/3.86)	#6
C	.168/.178 (4.27/4.52)	#8
D	.193/.203 (4.90/5.16)	#10
E	.260/.275 (6.60/6.99)	1/4
F	.323/.338 (8.20/8.59)	5/16
G	.385/.400 (9.78/10.16)	3/8
H	.448/.463 (11.38/11.76)	7/16
J	.510/.525 (12.95/13.34)	1/2
K	.573/.588 (14.55/14.94)	9/16
L	.651/.666 (16.54/16.92)	5/8
M	.770/.785 (19.56/19.94)	3/4
N	.895/.910 (22.73/ 23.11)	7/8

SYM	Insulation Material/Description
D0	High Performance Elastomer, Duraelectric Black
D1	High Performance Elastomer, Duraelectric Brown
D2	High Performance Elastomer, Duraelectric Red
D3	High Performance Elastomer, Duraelectric Orange
D4	High Performance Elastomer, Duraelectric Yellow
D5	High Performance Elastomer, Duraelectric Green
D6	High Performance Elastomer, Duraelectric Blue
D7	High Performance Elastomer, Duraelectric Violet
D8	High Performance Elastomer, Duraelectric Gray
D9	High Performance Elastomer, Duraelectric White
DDT	High Performance Elastomer, Duraelectric Desert Tan
DOG	High Performance Elastomer, Duraelectric Dark Olive Green
F	Fire / Caustic Chemical-Resistant Elastomer, Duraelectric F Blue

107-111 TurboFlex® Wire Rope Grounding Strap

GROUND STRAPS

SR - STRAIN RELIEF LUGS																			
Wire Size	AWG	CSA (KCMIL)	CSA (mm ²)	Nominal Resistance (mOhm/m)	A		B		D		E		F (REF)		G		Ø J		Max Lug Code (AS7928)
					±.05				±.05										
					In.	mm	In.	mm	In.	mm	In.	mm	In.	mm	In.	mm	In.	mm	
R	16	2.6	1.3	15.07	.19	4.83	.095	2.41	.050	1.27	.75	19.05	.120	3.05	.375	9.52	.063	1.60	A
A	12	6.5	3.3	6.11	.25	6.35	.125	3.18	.065	1.65	.87	22.10	.165	4.19	.450	11.43	.099	2.51	B
B	10	10.3	5.2	3.83	.30	7.62	.150	3.81	.075	1.90	1.00	25.40	.195	4.95	.550	13.97	.126	3.20	C
C	8	16.6	8.4	2.38	.35	8.89	.175	4.44	.090	2.29	1.12	28.45	.235	5.97	.625	15.88	.159	4.04	D
D	6	26.2	13.3	1.51	.42	10.67	.210	5.33	.100	2.54	1.25	31.75	.275	6.99	.700	17.78	.200	5.08	E
E	4	41.6	21.1	0.99	.54	13.72	.270	6.86	.130	3.30	1.50	38.10	.360	9.14	.875	22.23	.271	6.88	F
F	2	66.1	33.5	0.62	.64	16.26	.320	8.13	.150	3.81	1.75	44.45	.425	10.80	1.000	25.40	.342	8.69	G
G	1/0	105.3	53.4	0.39	.79	20.07	.395	10.03	.220	5.59	2.00	50.80	.525	13.34	1.125	28.58	.431	10.95	J
H	2/0	132.3	67.0	0.31	.88	22.35	.440	11.18	.240	6.10	2.25	57.15	.580	14.73	1.250	31.75	.483	12.27	K
I	3/0	169.6	85.9	0.25	.99	25.15	.495	12.57	.270	6.86	2.50	63.50	.650	16.51	1.500	38.10	.547	13.89	L
J	4/0	212.8	107.8	0.20	1.08	27.43	.540	13.72	.290	7.37	2.75	69.85	.710	18.03	1.750	44.45	.613	15.57	M

FRD - FLAT RADIUSED LUGS																	
Wire Size	AWG	CSA (KCMIL)	CSA (mm ²)	Nominal Resistance (mOhm/m)	A		B		D		E		R		Ø J		Max Lug Code (AS7928)
									±.05								
					In.	mm	In.	mm	In.	mm	In.	mm	In.	mm	In.	mm	
R	16	2.6	1.3	15.07	.19	4.83	.095	2.41	.055	1.40	.63	16.00	.095	2.41	.063	1.60	A
A	12	6.5	3.3	6.11	.25	6.35	.125	3.18	.075	1.90	.75	19.05	.125	3.18	.099	2.51	B
B	10	10.3	5.2	3.83	.30	7.62	.150	3.81	.085	2.16	.88	22.35	.150	3.81	.126	3.20	C
C	8	16.6	8.4	2.38	.35	8.89	.175	4.44	.105	2.67	1.00	25.40	.175	4.44	.159	4.04	D
D	6	26.2	13.3	1.51	.42	10.67	.210	5.33	.115	2.92	1.13	28.70	.210	5.33	.200	5.08	E
E	4	41.6	21.1	0.99	.54	13.72	.270	6.86	.150	3.81	1.25	31.75	.270	6.86	.271	6.88	F
F	2	66.1	33.5	0.62	.64	16.26	.320	8.13	.175	4.44	1.50	38.10	.320	8.13	.342	8.69	G
G	1/0	105.3	53.4	0.39	.79	20.07	.395	10.03	.215	5.46	1.75	44.45	.395	10.03	.431	10.95	J
H	2/0	132.3	67.0	0.31	.88	22.35	.440	11.18	.230	5.84	2.00	50.80	.440	11.18	.483	12.27	K
I	3/0	169.6	85.9	0.25	.99	25.15	.495	12.57	.255	6.48	2.25	57.15	.495	12.57	.547	13.89	L
J	4/0	212.8	107.8	0.20	1.08	27.43	.540	13.72	.280	7.11	2.50	63.50	.540	13.72	.613	15.57	M

107-111 TurboFlex® Wire Rope Grounding Strap

GROUND STRAPS

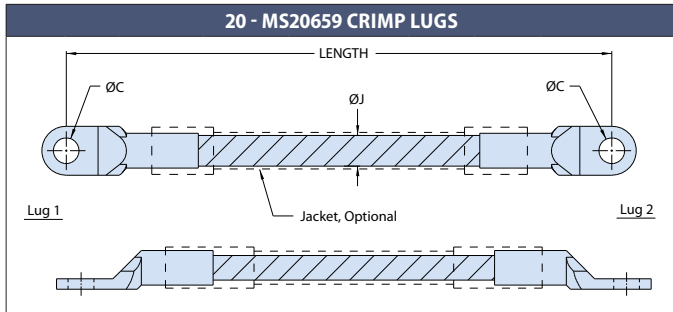

Wire Size	AWG	CSA (KCMIL)	CSA (mm ²)	Nominal Resistance (mOhm/m)	Ø J		Available Lug Hole Codes (AS7928)
					In.	mm	
R	16	2.6	1.3	15.07	.063	1.60	B, D
A	12	6.5	3.3	6.11	.099	2.51	B, D, F, G
B	10	10.3	5.2	3.83	.126	3.20	B, D, F, G
C	8	16.6	8.4	2.38	.159	4.04	C, D, E, F, G
D	6	26.2	13.3	1.51	.200	5.08	D, E, F, G
E	4	41.6	21.1	0.99	.271	6.88	D, E, F, G
F	2	66.1	33.5	0.62	.342	8.69	D, E, F, G, H, J
G	1/0	105.3	53.4	0.39	.431	10.95	E, F, G, H, J
H	2/0	132.3	67.0	0.31	.483	12.27	E, F, G, H, J
I	3/0	169.6	85.9	0.25	.547	13.89	F, G, H, J
J	4/0	212.8	107.8	0.20	.613	15.57	F, G, H, J

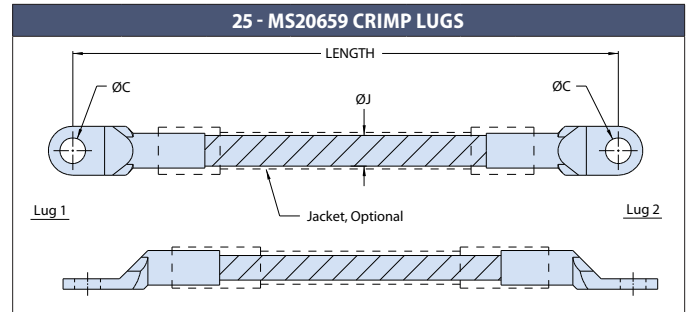

Wire Size	AWG	CSA (KCMIL)	CSA (mm ²)	Nominal Resistance (mOhm/m)	Ø J		Available Lug Hole Codes (AS7928)
					In.	mm	
R	16	2.6	1.3	15.07	.063	1.60	A, B, C, D, E, F, G, J
A	12	6.5	3.3	6.11	.099	2.51	B, C, D, E, F, G, J
B	10	10.3	5.2	3.83	.126	3.20	B, C, D, E, F, G, J
C	8	16.6	8.4	2.38	.159	4.04	D, E, F, G
D	6	26.2	13.3	1.51	.200	5.08	D, E, F, G
E	4	41.6	21.1	0.99	.271	6.88	E, F, G
F	2	66.1	33.5	0.62	.342	8.69	E, G, J
G	1/0	105.3	53.4	0.39	.431	10.95	E, G, J
H	2/0	132.3	67.0	0.31	.483	12.27	F, G, J
I	3/0	169.6	85.9	0.25	.547	13.89	G, J
J	4/0	212.8	107.8	0.20	.613	15.57	G, J

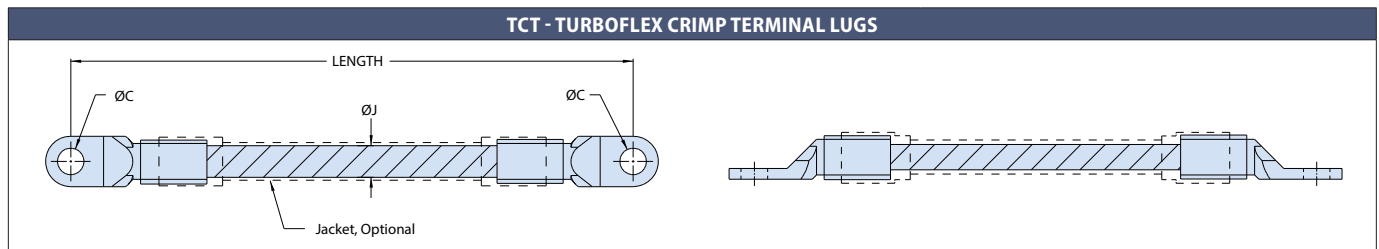

Wire Size	AWG	CSA (KCMIL)	CSA (mm ²)	Nominal Resistance (mOhm/m)	Ø J		Max Lug Hole Codes (AS7928)
					In.	mm	
C	8	16.6	8.4	2.38	.159	4.04	E
E	4	41.6	21.1	0.99	.271	6.88	G
F	2	66.1	33.5	0.62	.342	8.69	H
G	1/0	105.3	53.4	0.39	.431	10.95	J
H	2/0	132.3	67.0	0.31	.483	12.27	K
I	3/0	169.6	85.9	0.25	.547	13.89	L
J	4/0	212.8	107.8	0.20	.613	15.57	M

851-005

TERMINAL LUGS



HOW TO ORDER					
Sample Part Number	851-005	C	164	-CUSN	-1
Basic Part Number	Crimp Terminal Lugs for TurboFlex cable				
AWG Code / Size	See Size Code table				
Nominal Stud Size Dash No.	See Dimensions table				
Material / Finish	CUSN = Copper / Tin (max. temperature 175°C) CUNI = Copper / Nickel (max. temperature 200°C)				
Autoshrink Option	Add dash no. to include Autoshrink (See Tables). Omit for lug only.				

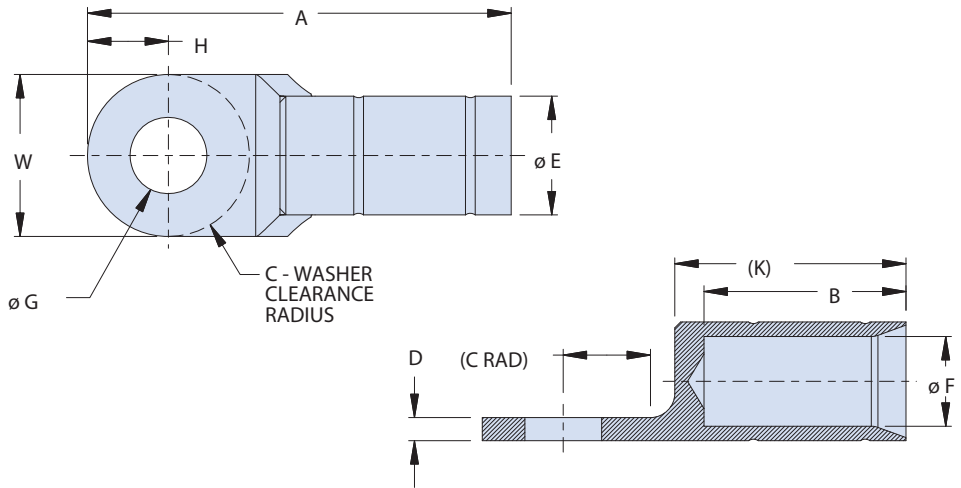

FEATURES

- Glenair 851 Series crimp terminal lugs are constructed from precision-machined high-conductivity copper alloy, purpose-built to fit TurboFlex high-flexibility power distribution cable
- Improved performance versus stamped and formed mil-spec lugs

MATERIAL SPECIFICATIONS

Lug material: High-conductivity copper alloy
 Finish: Tin plate per ASTM B545 or Nickel plate per AMS2403, AMS 2404, or AMS2424

COPPER TERMINAL CRIMP TOOL AND DIE SET				
Lug Size	AS5259/1 Crimping Head*	AS5259/4 Crimping Head*	AS5259/3 Crimping Tool	AS5259/5 Crimping Tool
	Die Set	Die Set	Die Set	Die Set
8	MS90485-8	M5259/7-001	MS90485-8	M5259/7-001
4	MS90485-4	M5259/7-003	MS90485-4	M5259/7-003
2	MS90485-2	M5259/7-004	MS90485-2	M5259/7-004
0	MS90485-01	M5259/7-006	MS90485-01	M5259/7-006
00	MS90485-02	M5259/7-007	MS90485-02	M5259/7-007
000	MS90485-03	N/A	N/A	N/A
0000	MS90485-04	N/A	N/A	N/A

*Requires Pump per AS5259/2.

Removal or cutting off of flash after crimping will result in exposed base metal. Glenair Autoshrink may be applied over the crimp barrel and wire, to environmentally protect exposed area. (see How to Order for Autoshrink option)

AUTOSHRINK DASH NO.	
Code	Color
-0	Black
-1	Brown
-2	Red
-3	Orange
-4	Yellow
-5	Green
-6	Blue
-7	Violet
-8	Gray
-9	White

AUTOSHRINK BASE PART NUMBER	
Terminal Base	Base P/N (Ref.)
8	777-035-0156-1.5
4	777-035-0250-2
2	777-035-0250-2
0	777-004-02-2
00	777-004-02-2
000	777-004-02-3
0000	777-004-02-3

SIZE CODE							
Terminal Size	8	4	2	0	00	000	0000
AWG Code	C	E	F	G	H	I	J

WIRE STRIP LENGTH							
Terminal Size	8	4	2	0	00	000	0000
Strip Length	.70 (17.78)	.87 (22.10)	1.03 (26.16)	1.09 (27.69)	1.21 (30.73)	1.42 (36.07)	1.62 (41.15)



851-005

TERMINAL LUGS

Stud Size Dash No.	Wire Size	Stud Size	DIMENSIONS											[K]
			A Max	B Min	C Min Rad	D		Ø E.O.D.	Ø F.I.D.	G		W & H*		
						Max	Min			Max	Min	Max	Min	
164	8	8 [.164]	1.284 (32.61)	.633 (16.08)	.234 (5.94)	.084 (2.13)	.064 (1.63)	.285 (7.24) .275 (6.99)	.183 (4.65) .173 (4.39)	.178 (4.52)	.168 (4.27)	.429 (10.90)	.386 (9.80)	[.72] (18.29)
190	8	10 [.190]	1.284 (32.61)	.633 (16.08)	.234 (5.94)	.084 (2.13)	.064 (1.63)	.285 (7.24) .275 (6.99)	.183 (4.65) .173 (4.39)	.203 (5.16)	.193 (4.90)	.429 (10.90)	.386 (9.80)	[.72] (18.29)
250	8	1/4 [.250]	1.340 (34.04)	.633 (16.08)	.265 (6.73)	.084 (2.13)	.064 (1.63)	.285 (7.24) .275 (6.99)	.183 (4.65) .173 (4.39)	.275 (6.99)	.260 (6.60)	.478 (12.14)	.435 (11.05)	[.72] (18.29)
190	4	10 [.190]	1.715 (43.56)	.800 (20.32)	.276 (7.01)	.096 (2.44)	.076 (1.93)	.438 (11.13) .428 (10.87)	.297 (7.54) .287 (7.29)	.203 (5.16)	.193 (4.90)	.628 (15.95)	.580 (14.73)	[.95] (24.13)
250	4	1/4 [.250]	1.715 (43.56)	.800 (20.32)	.276 (7.01)	.096 (2.44)	.076 (1.93)	.438 (11.13) .428 (10.87)	.297 (7.54) .287 (7.29)	.275 (6.99)	.260 (6.60)	.628 (15.95)	.580 (14.73)	[.95] (24.13)
312	4	5/16 [.312]	1.760 (44.70)	.800 (20.32)	.308 (7.82)	.096 (2.44)	.076 (1.93)	.438 (11.13) .428 (10.87)	.297 (7.54) .287 (7.29)	.338 (8.59)	.323 (8.20)	.648 (16.46)	.605 (15.37)	[.95] (24.13)
375	4	3/8 [.375]	1.780 (45.21)	.800 (20.32)	.328 (8.33)	.096 (2.44)	.076 (1.93)	.438 (11.13) .428 (10.87)	.297 (7.54) .287 (7.29)	.400 (10.16)	.385 (9.78)	.648 (16.46)	.605 (15.37)	[.95] (24.13)
312	2	5/16 [.312]	2.002 (50.85)	.960 (24.38)	.343 (8.71)	.109 (2.77)	.089 (2.26)	.532 (13.51) .522 (13.26)	.371 (9.42) .361 (9.17)	.338 (8.59)	.323 (8.20)	.711 (18.06)	.668 (16.97)	[1.13] (28.70)
375	2	3/8 [.375]	2.002 (50.85)	.960 (24.38)	.343 (8.71)	.109 (2.77)	.089 (2.26)	.532 (13.51) .522 (13.26)	.371 (9.42) .361 (9.17)	.400 (10.16)	.385 (9.78)	.711 (18.06)	.668 (16.97)	[1.13] (28.70)
437	2	7/16 [.437]	2.153 (54.69)	.960 (24.38)	.453 (11.51)	.109 (2.77)	.089 (2.26)	.532 (13.51) .522 (13.26)	.371 (9.42) .361 (9.17)	.463 (11.76)	.448 (11.38)	.804 (20.42)	.740 (18.80)	[1.13] (28.70)
375	0	3/8 [.375]	2.207 (56.06)	1.018 (25.86)	.418 (10.62)	.125 (3.18)	.105 (2.67)	.615 (15.62) .605 (15.37)	.466 (11.84) .456 (11.58)	.400 (10.16)	.385 (9.78)	.853 (21.67)	.810 (20.57)	[1.19] (30.23)
437	0	7/16 [.437]	2.267 (57.58)	1.018 (25.86)	.453 (11.51)	.125 (3.18)	.105 (2.67)	.615 (15.62) .605 (15.37)	.466 (11.84) .456 (11.58)	.463 (11.76)	.448 (11.38)	.903 (22.94)	.860 (21.84)	[1.19] (30.23)
500	0	1/2 [.500]	2.267 (57.58)	1.018 (25.86)	.453 (11.51)	.125 (3.18)	.105 (2.67)	.615 (15.62) .605 (15.37)	.466 (11.84) .456 (11.58)	.525 (13.34)	.510 (12.95)	.903 (22.94)	.860 (21.84)	[1.19] (30.23)
375	00	3/8 [.375]	2.436 (61.87)	1.141 (28.98)	.473 (12.01)	.129 (3.28)	.109 (2.77)	.691 (17.55) .681 (17.30)	.523 (13.28) .513 (13.03)	.400 (10.16)	.385 (9.78)	.956 (24.28)	.913 (23.19)	[1.31] (33.27)
437	00	7/16 [.437]	2.436 (61.87)	1.141 (28.98)	.473 (12.01)	.129 (3.28)	.109 (2.77)	.691 (17.55) .681 (17.30)	.523 (13.28) .513 (13.03)	.463 (11.76)	.448 (11.38)	.956 (24.28)	.913 (23.19)	[1.31] (33.27)
500	00	1/2 [.500]	2.436 (61.87)	1.141 (28.98)	.473 (12.01)	.129 (3.28)	.109 (2.77)	.691 (17.55) .681 (17.30)	.523 (13.28) .513 (13.03)	.525 (13.34)	.510 (12.95)	.956 (24.28)	.913 (23.19)	[1.31] (33.27)
375	000	3/8 [.375]	2.752 (69.90)	1.348 (34.24)	.513 (13.03)	.140 (3.56)	.120 (3.05)	.775 (19.68) .765 (19.43)	.588 (14.94) .578 (14.68)	.400 (10.16)	.385 (9.78)	1.053 (26.75)	1.010 (25.65)	[1.54] (39.12)
437	000	7/16 [.437]	2.752 (69.90)	1.348 (34.24)	.513 (13.03)	.140 (3.56)	.120 (3.05)	.775 (19.68) .765 (19.43)	.588 (14.94) .578 (14.68)	.463 (11.76)	.448 (11.38)	1.053 (26.75)	1.010 (25.65)	[1.54] (39.12)
500	000	1/2 [.500]	2.752 (69.90)	1.348 (34.24)	.513 (13.03)	.140 (3.56)	.120 (3.05)	.775 (19.68) .765 (19.43)	.588 (14.94) .578 (14.68)	.525 (13.34)	.510 (12.95)	1.053 (26.75)	1.010 (25.65)	[1.54] (39.12)
375	0000	3/8 [.375]	3.053 (77.55)	1.547 (39.29)	.560 (14.22)	.150 (3.81)	.130 (3.30)	.865 (21.97) .855 (21.72)	.656 (16.66) .646 (16.41)	.400 (10.16)	.385 (9.78)	1.148 (29.16)	1.095 (27.81)	[1.75] (44.45)
437	0000	7/16 [.437]	3.053 (77.55)	1.547 (39.29)	.560 (14.22)	.150 (3.81)	.130 (3.30)	.865 (21.97) .855 (21.72)	.656 (16.66) .646 (16.41)	.463 (11.76)	.448 (11.38)	1.148 (29.16)	1.095 (27.81)	[1.75] (44.45)
500	0000	1/2 [.500]	3.053 (77.55)	1.547 (39.29)	.560 (14.22)	.150 (3.81)	.130 (3.30)	.865 (21.97) .855 (21.72)	.656 (16.66) .646 (16.41)	.525 (13.34)	.510 (12.95)	1.148 (29.16)	1.095 (27.81)	[1.75] (44.45)

*H Max and Min dimensions shall be one half of the W Max and Min dimensions, respectively.

777-004 Straight Wall Tubing

SHRINK SLEEVES



Straight wall tubing provides a quick, reliable method of repairing the outer jacket of Duraelectric™ cables while providing mechanical and environmental protection from damage and debris. Autoshrink™ D Tubing is RoHS compliant, halogen free, and highly resistant to sunlight and ozone damage. Boots are water-tight when installed with 779-005 adhesive, sold separately. Choose tube based on wire bundle diameter. Service temperature range is -65°C to 225°C. 10 colors available.

How to Order					
Sample Part Number	777	-004	-01	-6	-1
Product Series	777 = Autoshrink™				
Basic Part Number	-004 = Straight wall tubing, Autoshrink™ D				
Size Code	See dimensions table				
Length	In inches, 12 inches maximum				
Color Code	See color table				

NOTES

1. Adhesive 779-005 sold separately
2. Material:
 - Tubing: Duraelectric™ D

Color Code	
Code	Color
0	Black
1	Brown
2	Red
3	Orange
4	Yellow
5	Green
6	Blue
7	Violet
8	Gray
9	White

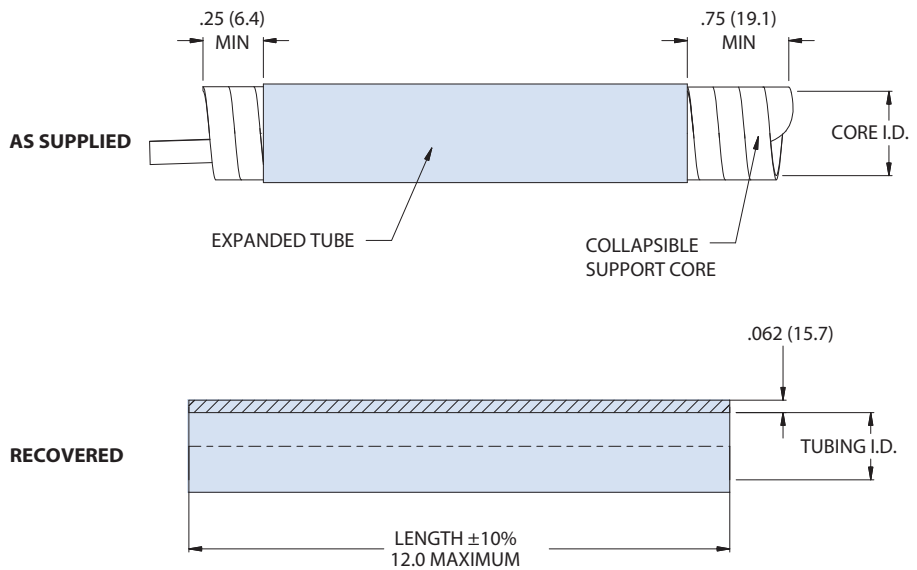

Dimensions			
Size Code	Tube I.D. After Unrestricted Shrinkage (Ref)	As Supplied Core I.D. (Ref)	Reference Wire Bundle Range Min/Max
01	.250 (6.35)	.80 (20.32)	.35 (8.89) / .65 (16.51)
02	.375 (9.52)	1.18 (29.97)	.55 (13.97) / 1.00 (25.40)
03	.625 (15.88)	2.00 (50.80)	.85 (21.59) / 1.65 (41.91)
04	.750 (19.05)	2.25 (57.15)	1.00 (25.40) / 2.00 (50.80)
05	.937 (23.80)	2.75 (69.85)	1.25 (31.75) / 2.50 (63.50)
06	1.437 (36.50)	4.00 (101.60)	2.00 (50.80) / 3.85 (97.79)

777-035 Small Diameter, Straight Wall Tubing



Straight wall small diameter tubing provides a quick, reliable method of repairing the outer jacket of Duraelectric™ cables while providing mechanical and environmental protection from damage and debris. Tubing is purpose designed for smaller diameter wires Autoshrink™ D Tubing is RoHS compliant, halogen free, and highly resistant to sunlight and ozone damage. Boots are water-tight when installed with 779-005 adhesive, sold separately. Choose tube based on wire bundle diameter. Service temperature range is -65°C to 225°C. 10 colors available.

SHRINK SLEEVES

How to Order					
Sample Part Number	777	-035	-0125	-6	-1
Product Series	777 = Autoshrink™				
Basic Part Number	-035 = Small diameter straight wall tubing, Autoshrink™ D				
Size Code	See dimensions table				
Length	In inches, see dimensions table for maximum length				
Color Code	See color table				

NOTES

1. Adhesive 779-005 sold separately
2. Material:
 - Tubing: Duraelectric™ D

Color Code	
Code	Color
0	Black
1	Brown
2	Red
3	Orange
4	Yellow
5	Green
6	Blue
7	Violet
8	Gray
9	White

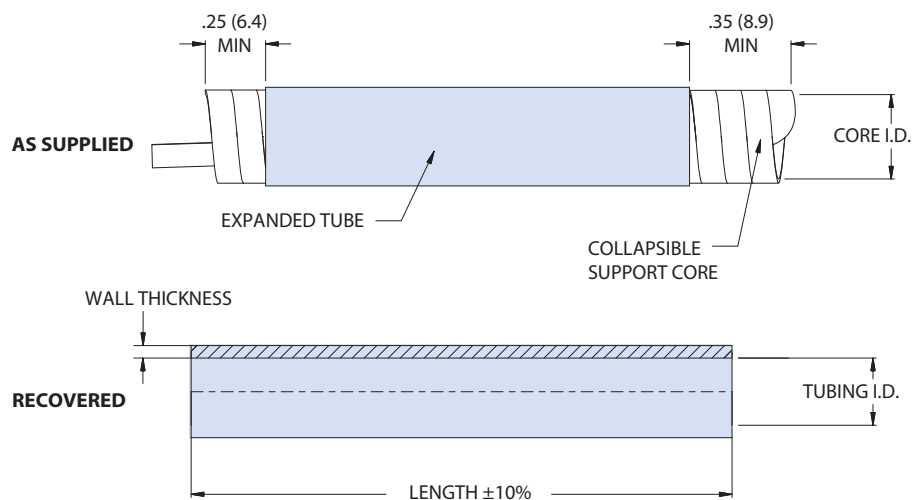

Dimensions						
Size Code	Tube I.D. After Unrestricted Shrinkage (Ref)	Wall Thickness (Ref)	Max Lenth	As Supplied Core I.D. (Ref)	Reference Wire Bundle Range	
					Min	Max
0062	.062 (1.57)	.031 (0.79)	4.00 (101.60)	.19 (4.83)	.09 (2.29)	.15 (3.81)
0080	.080 (2.03)	.031 (0.79)	4.00 (101.60)	.25 (6.35)	.12 (3.05)	.20 (5.08)
0125	.125 (3.2)	.047 (1.2)	6.00 (152.4)	.37 (9.4)	.15 (3.8)	.30 (7.6)
0156	.156 (4.0)	.062 (1.6)	12.00 (304.8)	.50 (12.7)	.19 (4.8)	.43 (10.9)
0250	.250 (6.35)	.062 (1.6)	12.00 (304.8)	.80 (20.3)	.30 (7.6)	.65 (16.5)
0375	.375 (9.52)	.062 (1.57)	12.00 (304.80)	1.18 (29.97)	55 (1397.00)	1.00 (25.40)
0500	.500 (12.70)	.062 (1.57)	12.00 (304.80)	1.50 (38.10)	.70 (17.78)	1.35 (34.29)



MISSION-CRITICAL
INTERCONNECT
SOLUTIONS

Glenair, Inc.

1211 Air Way • Glendale, California • 91201-2497

Telephone: 818-247-6500 • Fax: 818-500-9912 • sales@glenair.com

www.glenair.com

Glenair East

20 Sterling Drive
Wallingford, CT
06492

Telephone:
203-741-1115
Facsimile:
203-741-0053
sales@glenair.com

Glenair UK Ltd

40 Lower Oakham Way
Oakham Business Park
Mansfield, Notts
NG18 5BY England

Telephone:
+44-1623-638100
Facsimile:
+44-1623-638111
sales@glenair.co.uk

Glenair Microway Systems

7000 North Lawndale Avenue
Lincolnwood, IL
60712

Telephone:
847-679-8833
Facsimile:
847-679-8849

Glenair Nordic AB

Gustav III:s Boulevard 42
SE-169 27 Solna
Sweden

Telephone:
+46-8-50550000
sales@glenair.se

Glenair GmbH

Schaberweg 28
61348 Bad Homburg
Germany

Telephone:
06172 / 68 16 0
Facsimile:
06172 / 68 16 90
info@glenair.de

Glenair Iberica S.L.

Av. De Manoteras, 24 – 2º
28050 Madrid
Spain

Telephone:
+34 915 562 687
sales@glenair.es

Glenair Italia S.p.A.

Via Del Lavoro, 7
40057 Quarto Inferiore –
Granarolo dell'Emilia
Bologna, Italy

Telephone:
+39-051-782811
Facsimile:
+39-051-782259
info@glenair.it

Glenair France SARL

7, Avenue Parmentier
Immeuble Central Parc #2
31200 Toulouse
France

Telephone:
+33-5-34-40-97-40
Facsimile:
+33-5-61-47-86-10
sales@glenair.fr

Glenair Korea

6-21Tapsil-ro 58beon-gil
Giheung-gu, Yongin-si
Gyeonggi-do
Republic of Korea

Telephone:
+82-07-5067-2437
Facsimile:
+82-504-375-4549
sales@glenair.kr

Glenair Japan

40F, Nagoya Lucent Tower,
6-1, Ushijima-cho,
Nishi-ku, Nagoya, 451-6540
Japan

Telephone:
+81-52-569-2521
Facsimile:
+81-52-569-2523
sales@glenair.jp