

SERIES 792

High-Speed Ultraminiature Rectangular Connectors

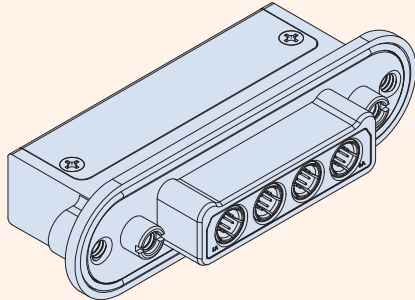

792-011S El Ochito® Right Angle PCB Plug Connector, Panel Mount 90° PC Tail Ochito Octaxial Contacts



Ultraminiature. High-speed. Right Angle Board Mount. Series 792 connectors are intended for 10Gb Ethernet, USB 3.0 and other multi-gigabit protocols. 792-011S connectors feature 90° PCB tails, Ochito octaxial contacts, machined aluminum shells and environmental protection. Scoop-proof interface for problem-free service. Military-grade performance and construction.

Technical Data

Specifications

- Operating temperature: -65 to +125 °C
- Current rating, size 23 contact: 5A
- Current rating, Ochito contacts: 1.5A
- Voltage rating (DWV): 500 Vac
- Shock: EIA-364-27 condition D
- Vibration: EIA-364-28 condition V, letter E
- Insulation Resistance: 5000 MΩ min.
- Altitude immersion: 75,000 feet

Construction

- Shell: aluminum alloy
- Metal insert: aluminum, nickel plated
- Insulators: high-grade rigid dielectric
- Contacts: copper alloy, 50 microinches gold over nickel plating
- Potting compound: epoxy
- O-ring: code F fluorosilicone, code C silver plated aluminum-filled fluorosilicone, code S gold plated copper alloy
- Hardware: 300 series SST, passivated

How To Order

	Sample P/N → 792-011S	C-3P3	M	G	AA	F
Product	792-011S = Panel Plug, 90° PC Tail Socket Contacts					
Insert Arrangement	See Table 2					
Shell Finish	M = Electroless Nickel MT = Nickel-PTFE					
Mating Hardware (Table 1)	N = No hardware P = Jackpost G = Male guide pin					
El Ochito® Protocol Code	See Table 3					
O-ring	N = No O-ring F = Fluorosilicone O-ring (non-conductive) C = Conductive fluorosilicone O-ring S = Metal EMI panel spring (non-environmental)					

Table 1 Mating Hardware

 N No Hardware Blind tapped holes 8-32 UNC-2B .150 (3.81) Min.	 P Jackposts Non-removable 8-32 UNC-2B thread	 G Guide Pins Non-removable
--	---	--

Table 2 Insert Arrangements

Insert arrangement	Number of Contacts		Insert arrangement	Number of Contacts	
	#23	#8		#23	#8
A-1P1, A-1G1*		1	C-9P3	6	3
A-3P1	2	1	D-27P3	24	3
B-23P1	22	1	D-4P4, D-4G4*		4
B-2P2, B-2G2*		2	D-12P4	8	4
B-6P2	4	2	E-45P3	42	3
C-24P2	22	2	E-5P5, E-5G5*		5
C-3P3, C-3G3*		3	E-15P5	10	5

Cavity identification numbers shown are for mating face of plug connectors with socket contacts.

* Insert arrangements with "G" designator are grounded type with metal insert. Insert arrangements with "P" designator have thermoplastic dielectric.

SERIES 792

High-Speed Ultraminiature Rectangular Connectors

792-011S El Ochito® Right Angle PCB Plug Connector, Panel Mount 90° PC Tail Ochito Octaxial Contacts

Ochito Protocols



WHITE
10GBASE-T



BLUE
USB 3.0

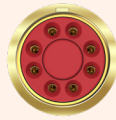

RED
HDMI, SATA,
DisplayPort

The Ochito octaxial contact has a color-coded insulator signifying the data protocol. White is used for 10 Gb Ethernet, blue is used for USB 3.0, and red is used for multi gigabit 100 ohm protocols including HDMI, DisplayPort and SATA. The connector part number includes a protocol code from Table 3. This code enables combinations of these protocols.

Table 3 Protocol Code

Code AE



Code AQ



Code	Cavity				
	A1	A2	A3	A4	A5
AA	W	W	W	W	W
AB	B	W	W	W	W
AC	R	W	W	W	W
AD	B	B	W	W	W
AE	R	B	W	W	W
AF	R	R	W	W	W
AG	B	B	B	W	W
AH	R	B	B	W	W
AJ	R	R	B	W	W
AK	R	R	R	W	W
AL	B	B	B	B	W
AM	R	B	B	B	W
AN	R	R	B	B	W
AP	R	R	R	B	W
AQ	R	R	R	R	W
AR	B	B	B	B	B
AS	R	B	B	B	B
AT	R	R	B	B	B
AV	R	R	R	B	B
AW	R	R	R	R	B
AX	R	R	R	R	R

792-011S Dimensions

Shell Size	A Max		B Basic		C Max		D Basic		E ±.002 (0.05)		F Max	
	In.	mm.	In.	mm.	In.	mm.	In.	mm.	In.	mm.	In.	mm.
A	2.220	56.39	1.075	27.31	.615	15.62	1.699	43.15	.725	18.42	1.455	36.96
B	2.595	65.91	1.450	36.83	.990	25.15	2.074	52.68	1.100	27.94	1.830	46.82
C	2.970	75.44	1.825	46.36	1.365	34.67	2.449	62.20	1.475	37.47	2.205	56.01
D	3.345	84.96	2.200	55.88	1.740	44.20	2.824	71.73	1.850	46.99	2.580	65.53
E	3.720	94.49	2.575	65.41	2.115	53.72	3.199	81.25	2.225	56.52	2.955	75.06

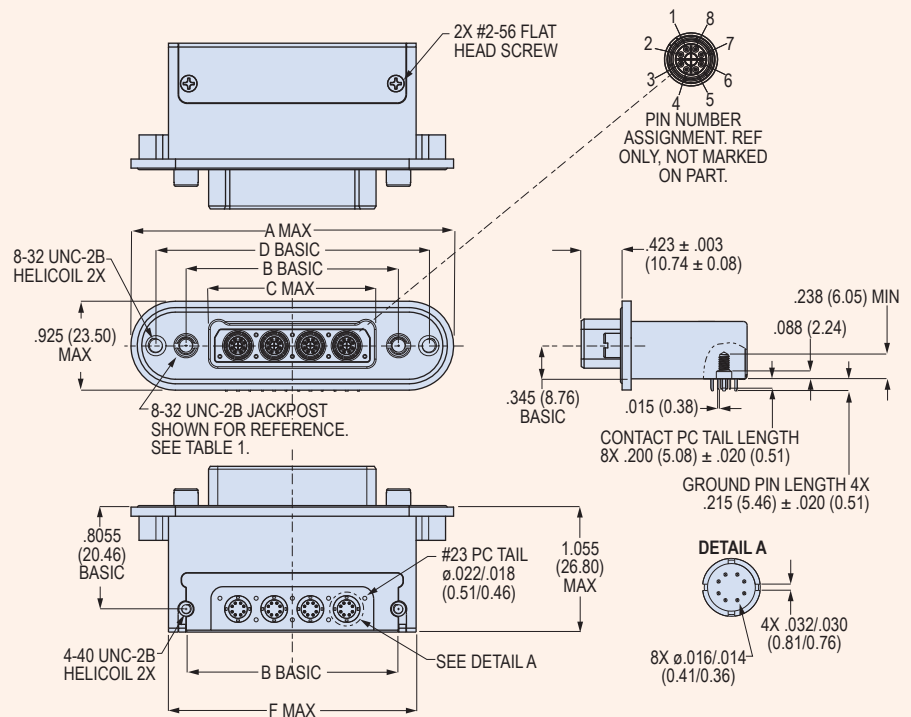

792-011S Panel Cutout

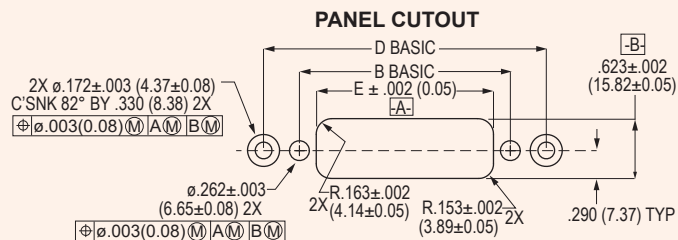

SERIES 792

High-Speed Ultraminiature Rectangular Connectors



792-011S El Ochito® Right Angle PCB Plug Connector, Panel Mount 90° PC Tail Ochito Octaxial Contacts

792-011S Printed Circuit Board Layouts

SHELL SIZE D

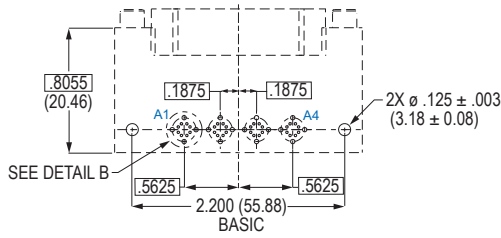

D-4P4, D-4G4

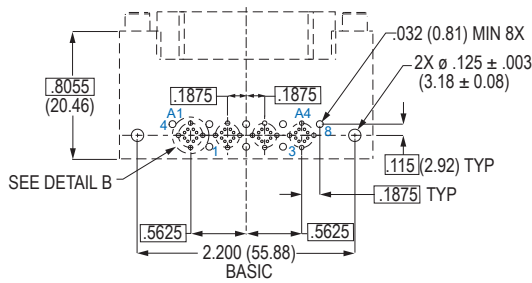

D-12P4

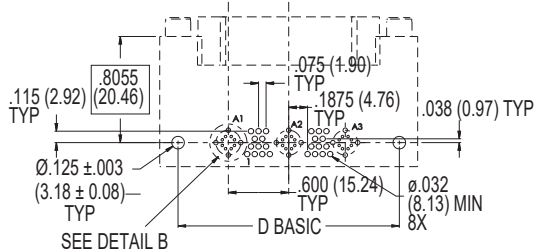

D-27W3

SHELL SIZE E

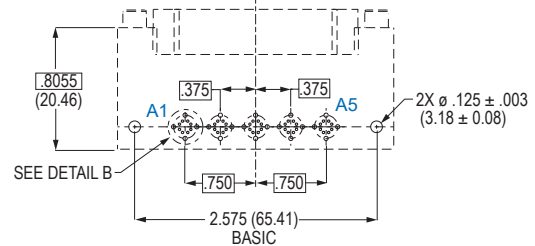

E-5P5, E-5G5

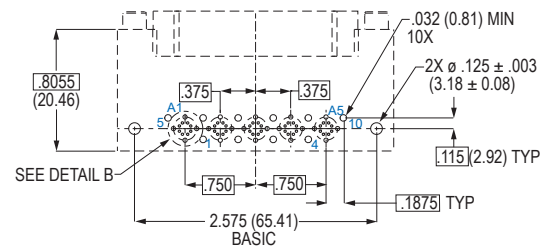

E-15P5

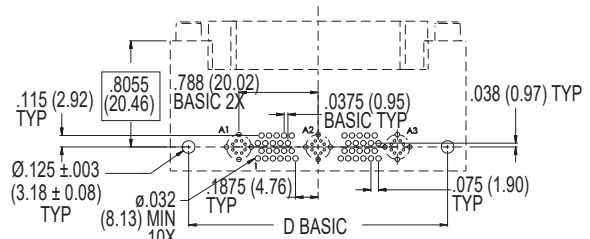

E-45W3

