

Panel Mount Connectors with Crimp-and-Poke Contacts

791-020S Panel Mount Plug Connectors with Socket Contacts

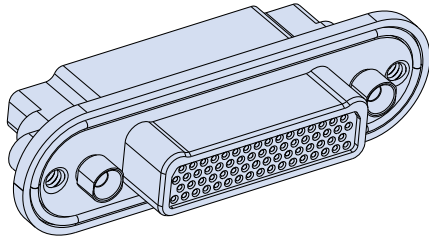

791-020S
Panel Mount Plug

Blind mate. Scoop-proof. Ultriminiature. Series 791 connectors save size and weight compared to M24308 D Subminiature and other rack-and panel connectors. Dual lobe shell for foolproof mating. Crimp, snap-in, rear release machined socket contacts. Environmentally protected with rubber wire grommet, face seal and O-ring. Aluminum shell, thermoplastic insulators and metal contact retention clips. Contacts are packaged with connector.

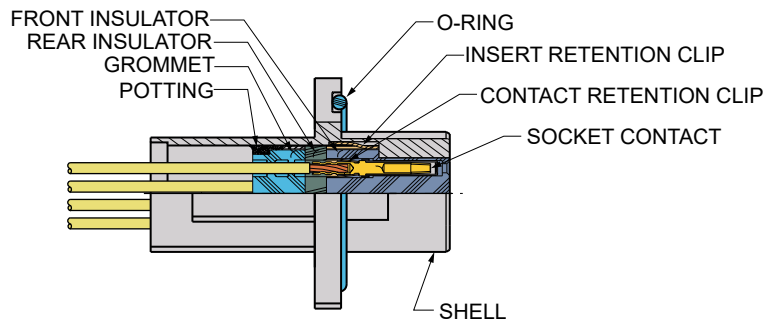

RELIABLE DESIGN

- 100% scoop-proof
- Snap-in, rear release contacts
- EMI shell-to-shell continuity
- Blind mate capability

VERSATILE

- Wide range of configurations
- Signal, power, RF, datalink
- Rear panel mount

HARSH ENVIRONMENT

- Humidity, water ingress
- Shock and vibration
- Temperature extremes
- Corrosion resistance
- High altitude

SIZE AND WEIGHT SAVING

- High density

Metal EMI Panel Spring

Gold-plated panel spring provides improved electrical bonding. Specify Code S. Non-environmental.



Wire Accommodation

Contact Size	Wire Range AWG
23	22 – 28
16	16 – 20
12	12 – 14
8	8

How To Order

Sample Part Number	791-020S	J-17P4	M	P	F
Product	791-020S = Panel Mount Plug, Crimp, with Socket Contacts				
Arrangement Number (Shell Size - Insert Arr.)	See Table 2				
Shell Finish	M = Electroless Nickel MT = Nickel-PTFE ZR = Black Zinc-Nickel				
Hardware Option (Table 1)	N = No hardware P = Jackpost G = Male guide pin B = Female guide bushing				
O-ring Option	N = No O-ring F = Fluorosilicone O-ring (non-conductive) C = Conductive fluorosilicone O-ring S = Metal EMI panel spring (non-environmental)				

Specifications

- **Operating temperature:** -65 to +150°C
- **Current and voltage ratings:**

Contact Size	Amps, max.	DWV Vac rms
23	5	750
16	13	1800
12	23	1800
8	46	1800
- **Shock:** EIA-364-27 condition D
- **Vibration:** EIA-364-28 condition V, letter E
- See pages 8-10 for additional information

Construction

- **Shell:** aluminum alloy
- **Insulators:** high grade rigid dielectric
- **Contacts:** copper alloy, 50 microinches gold over nickel plating
- **Encapsulant:** epoxy
- **O-ring:** fluorosilicone
- **Hardware:** stainless steel, passivated
- **O-ring (code F):** fluorosilicone
- **Conductive O-ring (code C):** silver plated, aluminum-filled fluorosilicone
- **Metal EMI panel spring (code S):** beryllium copper, gold plated

Panel Mount Connectors with Crimp-and-Poke Contacts

791-020S Panel Mount Plug Connectors with Socket Contacts

Table 1 Hardware Option











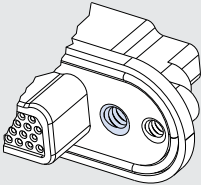
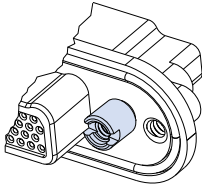
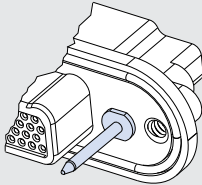
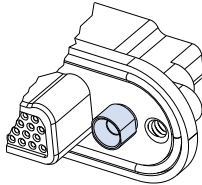





























 <p>N No Hardware</p> <p>Connector supplied with threaded holes, .150 (3.8) minimum depth. Shell sizes A-G, J, K have 6-32 UNC-2B thread, sizes H and L have 8-32 UNC-2B thread. Size M has 10-32 UNF-2B thread.</p>	 <p>P Jackposts</p> <p>Non-removable female jackpost. Shell sizes A-G, J, K have 4-40 UNC-2B thread, sizes H and L have 6-32 UNC-2B thread. Size M has 8-32 UNC-2B thread. 300 series stainless steel, passivated.</p>	 <p>G Guide Pins</p> <p>Non-removable, 300 series stainless steel guide pins for blind mating applications. Use with guide bushing on mating connector.</p>	 <p>B Guide Bushing</p> <p>Non-removable, 300 series stainless steel female guide bushings for blind mating applications. Use with guide pin on mating connector.</p>
---	---	---	--

Table 2 Arrangement Number

Change the "P" to a "W" in any combo arrangement to delete power contacts. For example, arrangement **H-10P4** is supplied with a total of 10 contacts including (4) #12 power pins and (6) signal pins. Arrangement **H-10W4** is supplied with (6) signal pins and no power pins. Order coax contacts separately.

Arrangements with Size #23 Contacts	Arrangements with Size #16 Contacts	Arrangements with Size #12 Contacts
 A-5 5 #23  B-9 9 #23  C-13 13 #23  D-15 15 #23  E-19 19 #23  F-23 23 #23  G-33 33 #23  H-66 66 #23  J-33 33 #23  K-43 43 #23  L-78 78 #23  M-102 102 #23	 B-2P2 2 #16  D-3P3 3 #16  D-7P2 5 #23, 2 #16  E-11P2 9 #23, 2 #16  E-7P3 4 #23, 3 #16  F-14P3 11 #23, 3 #16  F-15P2 13 #23, 2 #16  F-5P5 5 #16  H-29P7 22 #23, 7 #16  H-54P2 52 #23, 2 #16  J-17P4 13 #23, 4 #16  J-25P2 23 #23, 2 #16  J-7P7 7 #16  K-27P4 23 #23, 4 #16  K-35P2 33 #23, 2 #16  K-9P9 9 #16  M-17P17 17 #16	 G-13P2 11 #23, 2 #12  G-3P3 3 #12  G-21P1 20 #23, 1 #12  H-10P4 6 #23, 4 #12  H-36P2 34 #23, 2 #12  H-5P5 5 #12  L-6P6 6 #12 <p>Arrangements with Size #8 Contacts</p>  M-4P4 Supplied with 4 #8 Power Contacts  M-4W4 Contacts ordered separately, dielectric insert  M-4G4 contacts ordered separately, metal insert

Panel Mount Connectors with Crimp-and-Poke Contacts

791-020S Panel Mount Plug Connectors with Socket Contacts

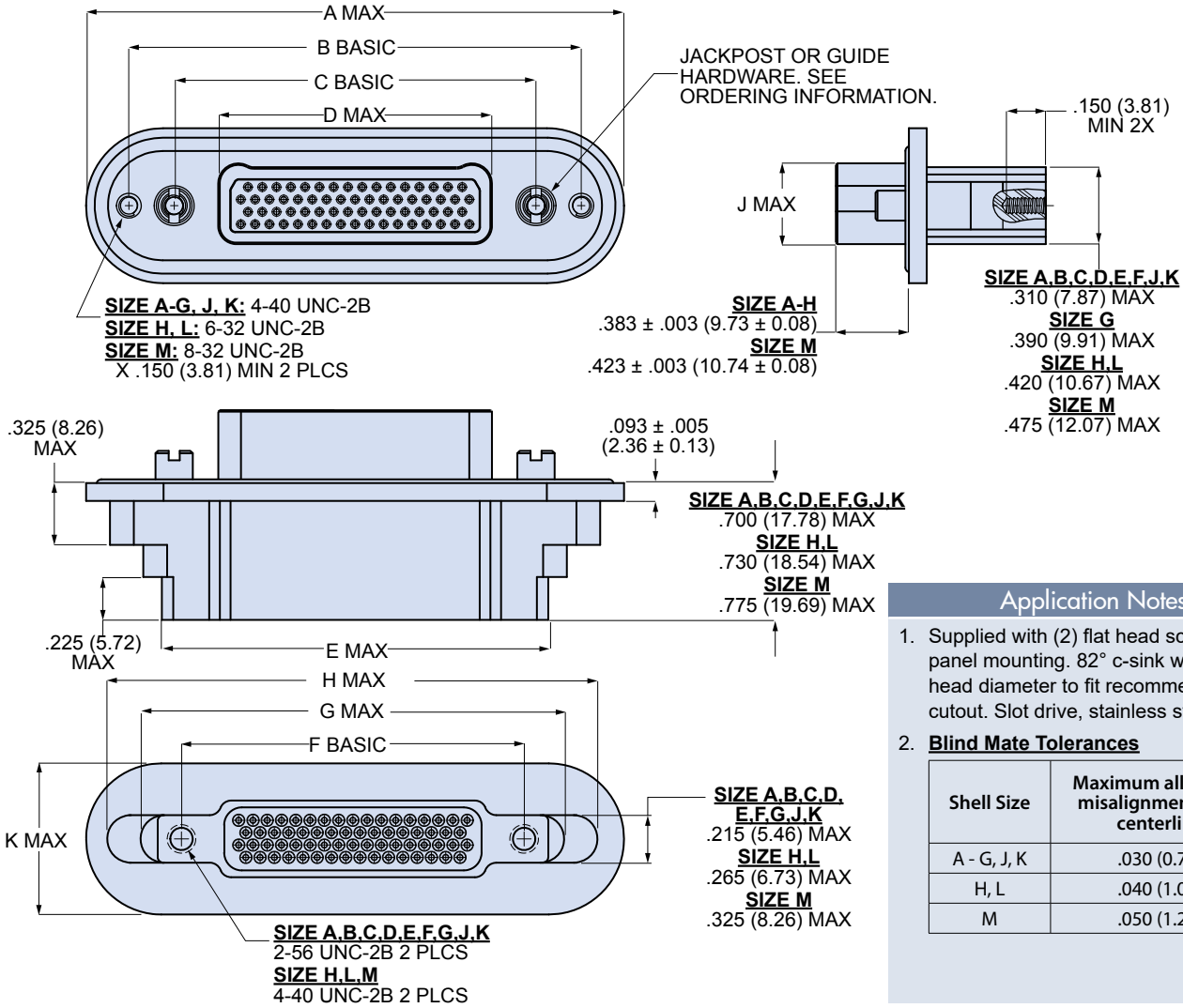

791-020S Dimensions

Shell Size	A Max		B Basic		C Basic		D Max		E Max		F Basic		G Max		H Max		J Max		K Max	
	In.	mm.	In.	mm.	In.	mm.	In.	mm.	In.	mm.	In.	mm.	In.	mm.	In.	mm.	In.	mm.	In.	mm.
A	1.565	39.75	1.150	29.21	.750	19.05	.410	10.41	.760	19.30	.565	14.35	.960	24.38	1.345	34.16	.320	8.13	.710	18.03
B	1.715	43.56	1.300	33.02	.900	22.86	.560	14.22	.910	21.11	.715	18.16	1.110	28.19	1.495	37.97	.320	8.13	.710	18.03
C	1.865	47.37	1.450	36.83	1.050	26.67	.710	18.03	1.060	26.92	.865	21.97	1.260	32.00	1.645	41.78	.320	8.13	.710	18.03
D	1.940	49.28	1.525	38.74	1.125	28.58	.785	19.94	1.160	29.46	.965	24.51	1.360	34.54	1.745	44.32	.320	8.13	.710	18.03
E	2.090	53.09	1.675	42.55	1.275	32.39	.935	23.75	1.310	33.27	1.115	28.32	1.510	38.35	1.895	48.13	.320	8.13	.710	18.03
F	2.240	56.90	1.825	46.36	1.425	36.20	1.085	27.56	1.460	37.08	1.265	32.13	1.660	42.16	2.045	51.94	.320	8.13	.710	18.03
G	2.200	55.88	1.785	45.34	1.388	35.26	1.047	26.59	1.410	35.81	1.215	30.86	1.633	41.48	1.983	50.37	.420	10.67	.800	20.32
H	2.835	72.01	2.375	60.34	1.900	48.26	1.437	36.50	2.045	51.94	1.800	45.72	2.240	56.90	2.590	65.79	.430	10.92	.820	20.83
J	2.615	66.42	2.200	55.88	1.800	45.72	1.460	37.08	1.810	45.97	1.615	41.02	2.010	51.05	2.395	60.83	.320	8.13	.710	18.03
K	2.990	75.95	2.575	65.41	2.175	55.25	1.835	46.61	2.210	56.13	2.015	51.18	2.410	61.21	2.795	70.99	.320	8.13	.710	18.03
L	3.075	78.11	2.611	66.32	2.136	54.25	1.673	42.49	2.281	57.93	2.036	51.71	2.476	62.89	2.826	71.78	.430	10.92	.820	20.83
M	3.333	84.58	2.824	71.73	2.200	55.88	1.734	44.04	2.445	62.10	2.200	55.88	2.650	67.31	3.090	78.49	.515	13.08	.925	23.50

Panel Mount Connectors with Crimp-and-Poke Contacts

791-020S Panel Mount Plug Connectors with Socket Contacts

Recommended Panel Cutout

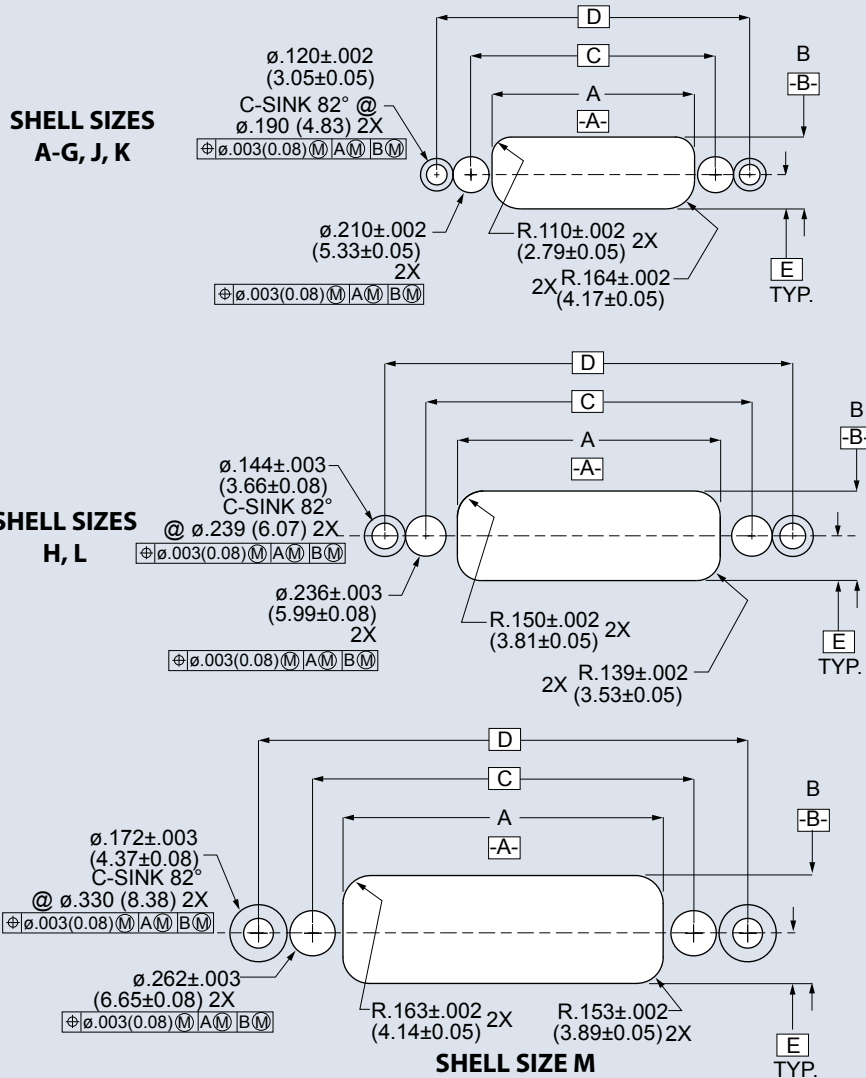

Shell Size	A ±.002(0.05)		B ±.002(0.05)		C Basic		D Basic		E Basic	
	In.	mm.	In.	mm.	In.	mm.	In.	mm.	In.	mm.
A	.505	12.83	.418	10.62	.750	19.50	1.150	29.21	.199	5.00
B	.655	16.64	.418	10.62	.900	22.86	1.300	33.02	.199	5.00
C	.805	20.45	.418	10.62	1.050	26.67	1.450	36.83	.199	5.00
D	.880	22.35	.418	10.62	1.125	28.58	1.525	38.74	.199	5.00
E	1.030	26.16	.418	10.62	1.275	32.39	1.675	42.55	.199	5.00
F	1.180	29.97	.418	10.62	1.425	36.20	1.825	46.36	.199	5.00
G	1.142	29.01	.506	12.85	1.388	35.25	1.786	45.34	.244	6.15
H	1.531	38.89	.521	13.23	1.900	48.26	2.375	60.34	.250	6.55
J	1.555	39.50	.418	10.62	1.800	45.72	2.200	55.88	.199	5.00
K	1.930	49.02	.418	10.62	2.175	55.25	2.575	65.41	.199	5.00
L	1.767	44.88	.521	13.23	2.136	54.26	2.611	66.32	.250	6.55
M	1.850	46.99	.623	15.82	2.200	55.88	2.824	71.73	.290	7.37

Crimp Tools

Contact Size	Crimper	Positioner	Die
23	809-015 (M22520/2-01)	809-005 (no mil spec #)	(not required)
16	809-136 (M22520/1-01)	809-137 (M22520/1-04)	(not required)
12	809-136 (M22520/1-01)	809-137 (M22520/1-04)	(not required)
8	859-025 (M22520/23-01)	859-046 (WA23-395L)	859-026 (M22520/23-02)

Note: see "Contacts and Tools" section for additional information

Insertion/Removal Tools

Contact Size	Insertion/Removal Tool
23	809-088 (no mil spec #)
16	809-131 (M81969/14-03)
12	809-132 (M81969/14-04)
8	859-049 (M81969/14-12)